

Residential AIR TO WATER

- W-002 AIR TO WATER Overview
- W-004 AIR TO WATER Lineup
- W-006 Benefits
- W-008 Home Heating & Domestic Hot Water Supply
- W-010 High-Efficiency Technology
- W-012 Split Type
 - Comfort Series
 - Super High Power Series
 - High Power Series
- W-018 Split DHW Integrated Type
 - Comfort Series
 - Super High Power Series
 - High Power Series
- W-024 Control Overview
- W-026 Comfort Control
- W-028 System Configuration
- W-030 Case Studies
- W-032 Simple installation
 - Easy Installation & Maintenance
- W-034 Installation requirements
- W-035 AIR TO WATER Optional Parts



AIR TO WATER
Residential



FUJITSU GENERAL LIMITED

AIR TO WATER Overview

Solutions that meet a variety of needs

Water heated by Air to water using clean energy is delivered reliably and comfortably throughout the house, including the living room.



Heat Pump System Framework

Heat is absorbed from the atmosphere by expanding the refrigerant. Higher-temperature heat is generated by compressing the refrigerant, and the indoor unit transfers that heat to the water.

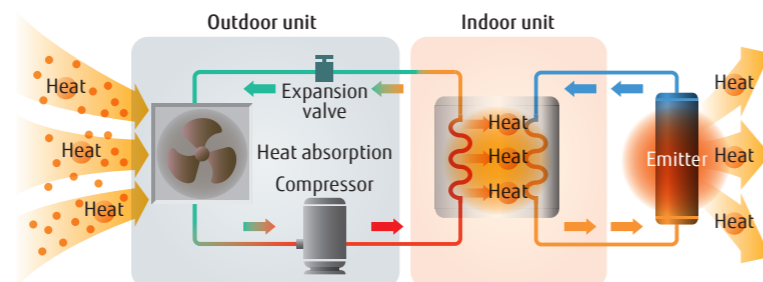

Our Goal

Decarbonisation

European Commission is committed to decarbonisation and has a national target of "Net Zero" carbon emissions by 2050.

We need to reduce carbon emissions with green technology products and increase carbon absorption by working to extend nature.

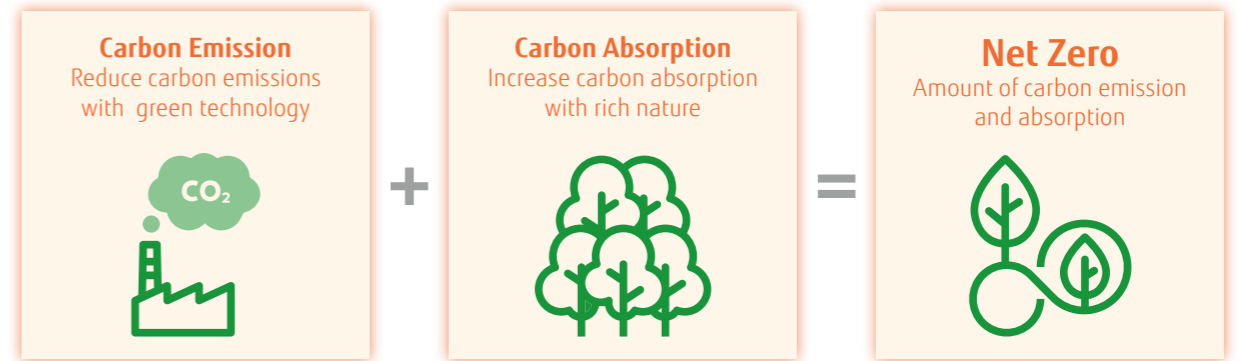

Fujitsu General's ATW system will provide the best solutions that are friendly to the environment and people with products conscious of decarbonisation.

The Choice of ATW

Optimized refrigerant cycle operation

Super High Power and High Power Series deliver high performance and efficiency with twin sensors and hot water heating technology.

Split Type

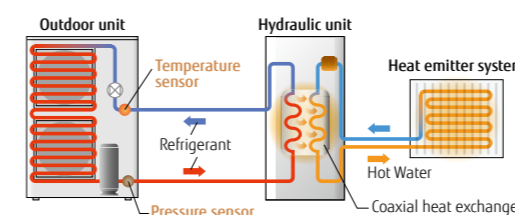

Split DHW Integrated Type

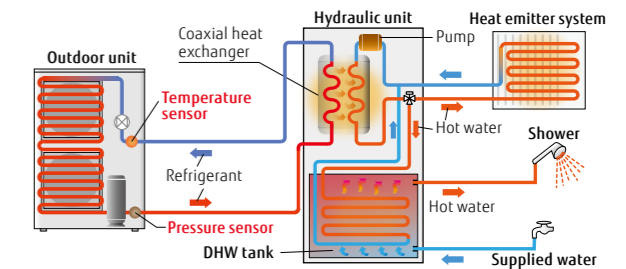

What is a heat pump?

A heat pump extracts heat energy from the atmosphere. It requires only 1 kWh of electricity to generate 3 to 5 kWh of thermal energy.

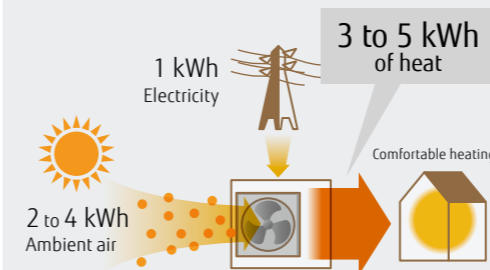

Primary energy usage reduced substantially

Proportion of primary energy converted into heating energy is 100%

Primary Energy Consumption*

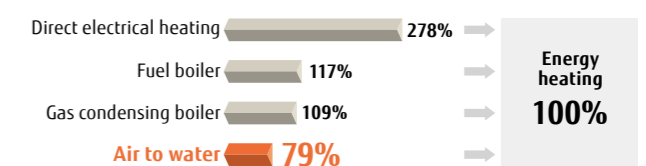

* The amount of electricity loss varies according to the power plant. Typical energy efficiency of a power plant: 36%

AIR TO WATER Lineup



Type	Split Type						Split DHW Integrated Type							
	Comfort Series		Super High Power Series		High Power Series		Comfort Series		Super High Power Series		High Power Series			
Hydraulic unit														
Outdoor unit														
Capacity range	5/6 kW	8 kW	10 kW	16 kW	15/17 kW	11/14 kW	11/14/16 kW	5/6 kW	8 kW	10 kW	16 kW	15/17 kW	11/14 kW	11/14/16 kW
System outline	<ul style="list-style-type: none"> Supplies 55°C hot water even when the outdoor temperature is -10°C. Heating and DHW supply in one system.* Equipped with additional electric heater for backup Up to two independent control circuits.* Cooling operation is possible.* Operating range is -20 to 35°C. Can be used with a variety of heating systems, including underfloor heating and radiators.* 		<ul style="list-style-type: none"> Supplies 60°C hot water even when the outdoor temperature is -20°C. Supplies 55°C hot water even when the outdoor temperature is -22°C. Can be used with a variety of heating systems, including underfloor heating and radiators.* Heating and DHW supply in one system.* Equipped with additional electric heater for backup Up to two independent control circuits.* Cooling operation is possible.* Operating range is -25 to 35°C. 		<ul style="list-style-type: none"> Supplies 60°C hot water even when the outdoor temperature is -20°C. Can be used with a variety of heating systems, including underfloor heating and radiators.* Heating and DHW supply in one system.* Up to two independent control circuits.* Cascade connection is possible for up to three systems.* Cooling operation is possible.* Operating range is -25 to 35°C. 		<ul style="list-style-type: none"> Supplies 55°C hot water even when the outdoor temperature is -10°C. Heating and DHW supply in one system. Equipped with additional electric heater for backup Up to two independent control circuits.* Cooling operation is possible.* Operating range is -20 to 35°C. Can be used with a variety of heating systems, including underfloor heating and radiators.* 		<ul style="list-style-type: none"> Supplies 60°C hot water even when the outdoor temperature is -20°C. Supplies 55°C hot water even when the outdoor temperature is -22°C. Can be used with a variety of heating systems, including underfloor heating and radiators.* Space saving heating and DHW supply in a single Hydraulic unit Equipped with additional electric heater for backup Up to two independent control circuits.* Cooling operation is possible.* Operating range is -25 to 35°C. 		<ul style="list-style-type: none"> Supplies 60°C hot water even when the outdoor temperature is -20°C. Can be used with a variety of heating systems, including underfloor heating and radiators.* Space saving heating and DHW supply in a single Hydraulic unit Up to two independent control circuits.* Cooling operation is possible.* Operating range is -25 to 35°C. 			
Power source	Single phase, ~230 V, 50 Hz		Single phase, ~230 V, 50 Hz	3-phase, ~400 V, 50 Hz	Single phase, ~230 V, 50 Hz	3-phase, ~400 V, 50 Hz	Single phase, ~230 V, 50 Hz		Single phase, ~230 V, 50 Hz	3-phase, ~400 V, 50 Hz	Single phase, ~230 V, 50 Hz	3-phase, ~400 V, 50 Hz		
Capacity	5 kW	WSYA050ML3 WOYA060KLT						WGYA050ML3 WGYA060KLT						
	6 kW	WSYA080ML3 WOYA060KLT						WGYA080ML3 WGYA060KLT						
	8 kW	WSYA080ML3 WOYA080KLT						WGYA080ML3 WGYA080KLT						
	10 kW	WSYA100ML3 WOYA100KLT						WGYA100ML3 WOYA100KLT						
	11 kW				WSYG140DG6 WOYG112LHT	WSYK160DG9 WOYK112LCTA					WGYK140DG6 WGYK112LHT	WGYK160DG9 WGYK112LCTA		
	14 kW				WSYG140DG6 WOYG140LCTA	WSYK160DG9 WOYK140LCTA					WGYK140DG6 WGYK140LCTA	WGYK160DG9 WGYK140LCTA		
	15 kW										WGYK170DJ9 WGYK150LJL			
	16 kW				WSYG160DJ6 WOYG160LJL		WSYK160DG9 WOYK160LCTA				WGYK160DJ6 WGYK160LJL		WGYK160DG9 WGYK160LCTA	
17 kW										WGYK170DJ9 WGYK170LJL				
Approval														

* Please refer to page W-038 and W-039 for optional parts information.

Benefits

Less CO₂ Emissions

Air to water is an environmentally friendly system that emits substantially less carbon dioxide than conventional gas and hydrocarbon combustion systems.

Average annual CO₂ emissions

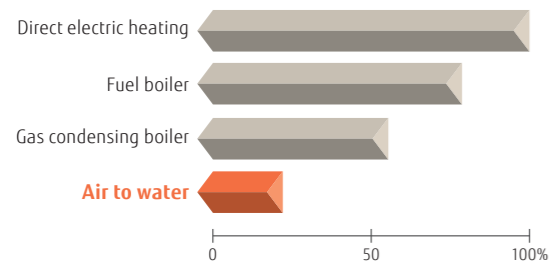

*Calculations based on energy efficiency data provided by the European Programme for Energy Efficiency in EU-27: 89% for fuel boilers; 93% for gas boiler

Clean and Healthy

As an Air to water system does not use a burner to heat water, it does not produce NO_x or other harmful substances.



Environmentally friendly heating system



Low Running Cost

High-efficiency heat pump technology keeps the running cost of an Air to water system.

Average annual running cost

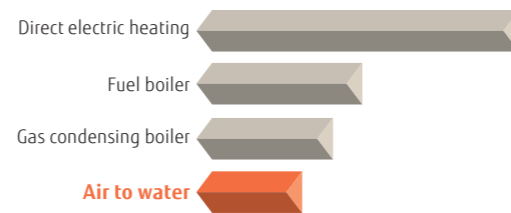

*The running cost may vary depending on a system's installation, geographical location, and operating conditions.

Easy Installation and Maintenance

All components are built into a compact outdoor unit or a Hydraulic unit.



Well-designed Hydraulic unit
The sophisticated arrangement of Hydraulic units makes piping and maintenance work easy.

Energy Efficiency Standards Product labels

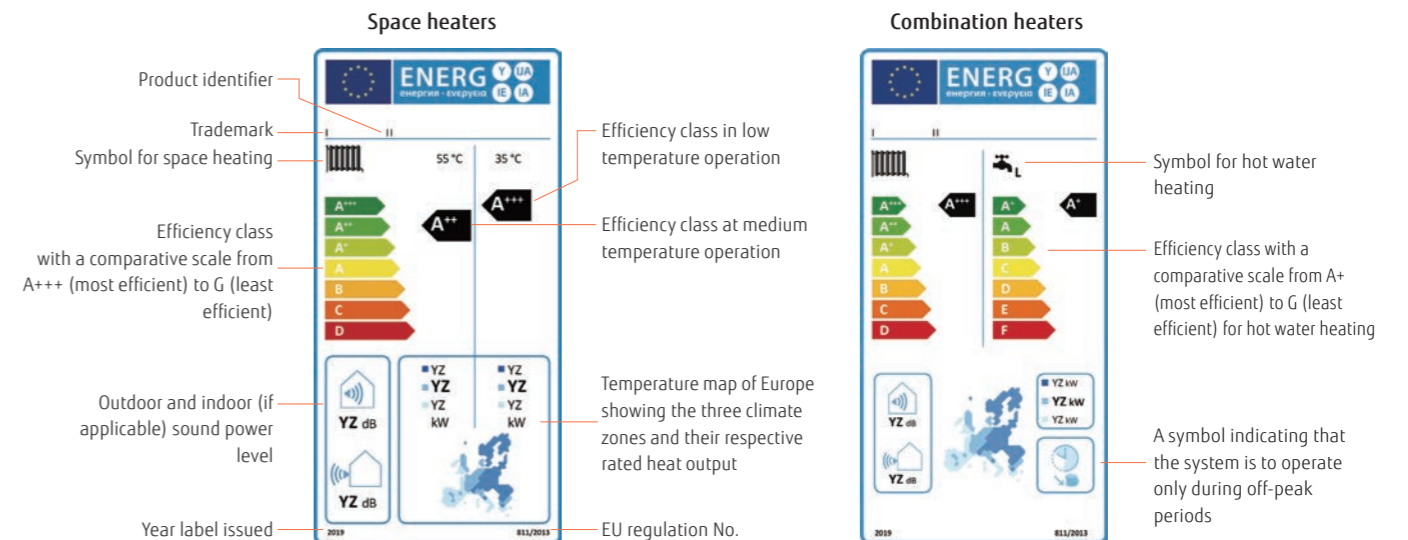

The Ecodesign Directive Lot 1 Regulation 813/2013

The Ecodesign directive defines a regulatory framework for improving the environmental performance of energy-related products (ErP) through design. Since September 26, 2015, the Ecodesign Directive has applied to space heaters, including heat pumps and fossil fuel fired boilers, combination heaters for space and hot water heating, water heaters, and water storage tanks.

All of these products must meet minimum requirements for energy efficiency*¹ and maximum sound power level. The minimum energy efficiency class were raised on September 26, 2017, and the maximum sound levels were lowered on September 26, 2018.

*1: Energy efficiency is expressed in terms of seasonal space heating efficiencies (η_s). The value is based upon the Seasonal Coefficient of Performance (SCOP).

The Energy Labelling Directive (EU) No. 811/2013

Energy label is intended to enable consumers to make direct comparisons of energy use and product features. All labels should indicate the product identifier, efficiency class, sound power level, and heat output. Heat generators are rated A+++ to D. There are two different product labels. One for space heaters and one for combination heaters.

Seasonal space heating Energy efficiency class

Class	Except low temp. HP 55°C	Low temp. HP 35°C
A+++	η _s ≥ 150	η _s ≥ 175
A++	125 ≤ η _s < 150	150 ≤ η _s < 175
A+	98 ≤ η _s < 125	123 ≤ η _s < 150
A	90 ≤ η _s < 98	115 ≤ η _s < 123
B	82 ≤ η _s < 90	107 ≤ η _s < 115
C	75 ≤ η _s < 82	100 ≤ η _s < 107
D	36 ≤ η _s < 75	61 ≤ η _s < 100
E	34 ≤ η _s < 36	59 ≤ η _s < 61
F	30 ≤ η _s < 34	55 ≤ η _s < 59
G	η _s < 30	η _s < 55

EHPA Quality Label



Fujitsu General's Air to water² has acquired the EHPA Quality Label³ through testing in accordance with the International Standards EN14511 and EN17025. The EHPA Quality Label³ is a label that shows the end-consumer a quality heat pump unit on the market.

*2: 3-phase High Power Series only
*3: Learn more about the validity of the mark at www.ehpa.org/quality/quality-label/

SG ready Label



SG ready is a label issued to heat pumps and their control technologies that meet the requirements set by BWP⁴, and technologies that conform to their standards can be integrated into a smart grid. SG ready labeled heat pumps receive signals from the power grid and PV systems with regard to energy and renewable energy sources such as wind, solar, and water. All of Fujitsu General's new heat pump series are SG ready compatible.

*4: BWP: Bundesverband Wärmepumpe e. V (Federal German Heat Pump Association)

The CEN Heat Pump KEYMARK



The Heat Pump KEYMARK is a full certificate supporting the quality of heat pumps in the European market. The Heat Pump KEYMARK is a voluntary, independent, European certification mark (ISO Type 5 Certification) for all heat pumps, combination heat pumps, and hot water heaters (as covered by Ecodesign, EU Regulation 813/2013 and 814/2013). Fujitsu General's Air to water⁵ has acquired the KEYMARK certificate⁶.

*5: R32 refrigerant comfort model only
*6: Learn more about the validity of the mark at www.heatpumpkeymark.com/about/

Home Heating & Domestic Hot Water Supply

A wide range of products to suit regional characteristics, family structures, and usage patterns. We provide a variety of products to meet the needs of customers from the heating-centered High Power Series to the reasonably priced Compact Series.

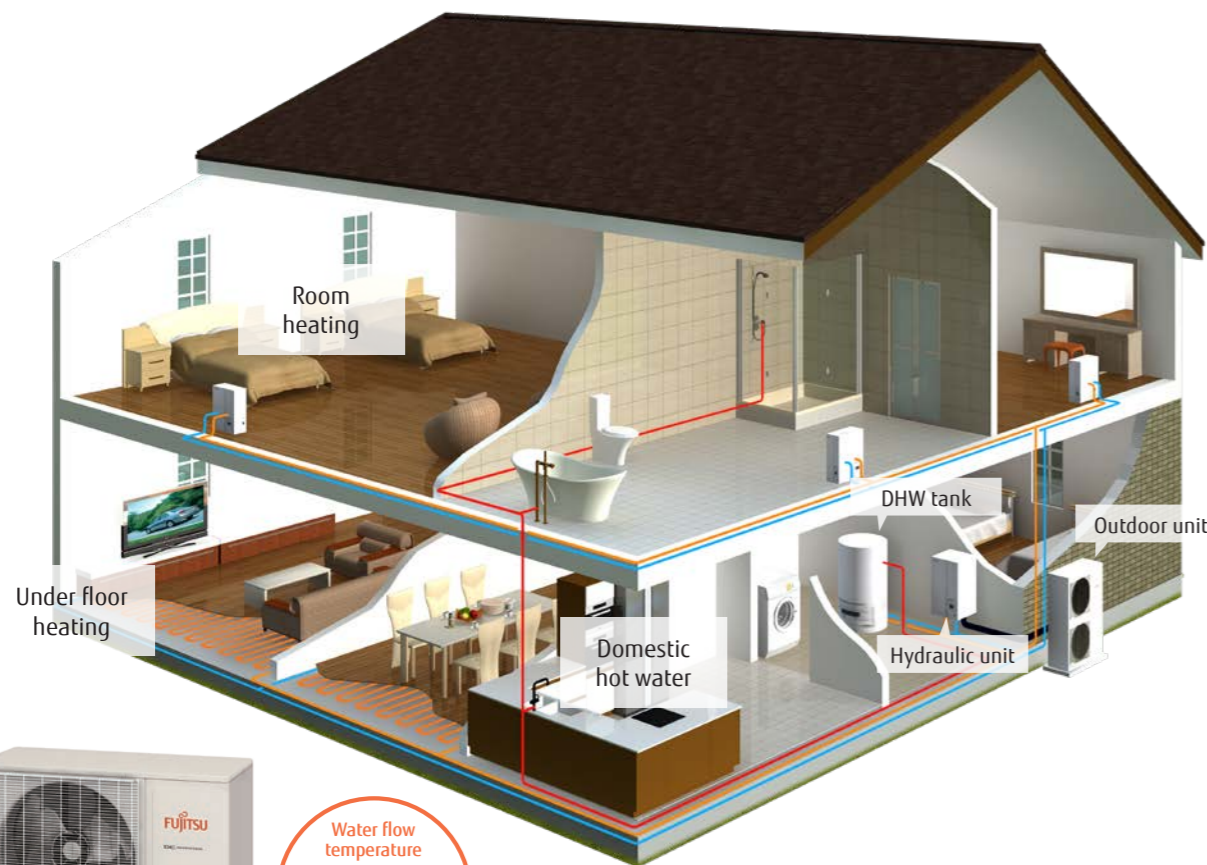

Water flow temperature
60°C

Super High Power Series
High Power Series

High water flow temperature

The temperature of water flow can be maintained at 60°C without using a backup heater, even when the outdoor temperature drops to -20°C.

Floor heating and domestic hot water supply

Outdoor units and hydraulic indoor units can be installed flexibly and easily. Hydraulic units installed inside the house prevent the circulating water from freezing. More units can be cascaded together to provide a greater heating capacity with greater flexibility.*

*1: High Power Series only



Adopting R32 refrigerant

R32 refrigerant is an environmentally friendly refrigerant with a significantly lower Global Warming Potential (GWP) than conventional refrigerants.



+ DHW tank

A DHW tank (optional) can be connected to supply hot water.

+ Boiler

By combining with an existing boiler, powerful heating can be achieved even at low outdoor temperature.

* Please refer to page W-038 and W-039 for optional parts information.

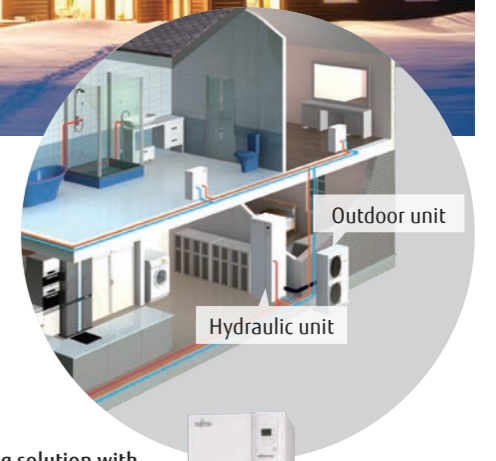

Stylish space saving solution with built-in DHW tank



Built-in DHW tank saves a great deal of space.

Existing boilers can be replaced easily. A higher heating capacity can be achieved with the flexibility to cascade more units.

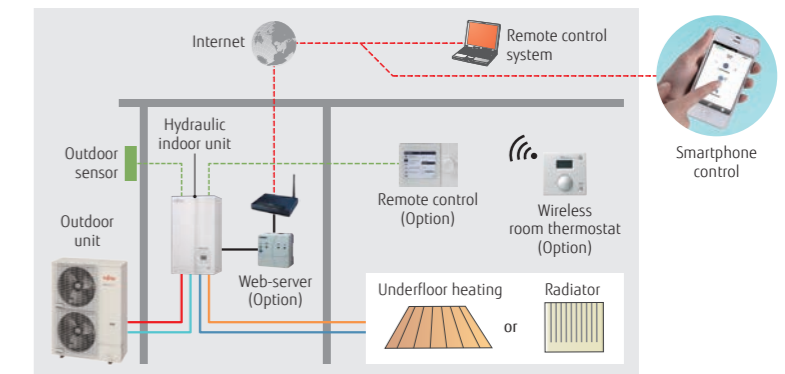

Smart control

To meet the diverse needs of customers, we offer a variety of control options, such as individual control and remote control options.

High-Efficiency Technology

Twin-Rotary Compressor



For Outdoor unit

Twin-Rotary Compressor with Linear Control Injection Port

The compressor achieves a high condensing temperature without overheating the discharge gas temperature due to the Linear control injection process used during compression. This makes the condensing temperature higher than in a normal circuit. Higher water temperatures can be achieved by controlling the injection volume according to usage conditions.

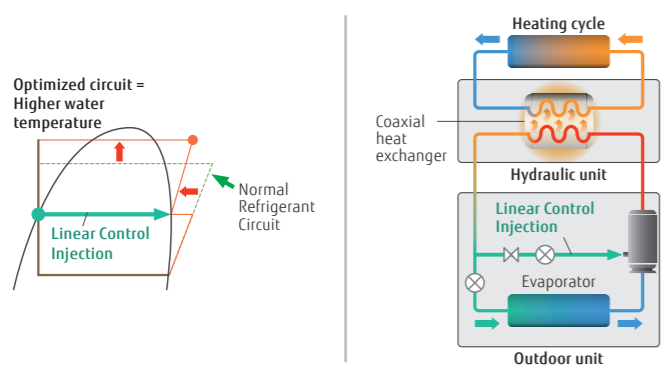

DC inverter technology controls temperatures precisely.

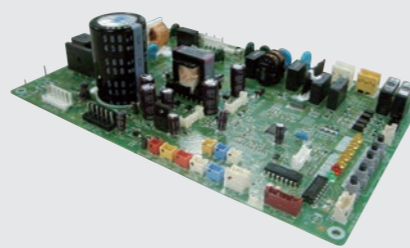
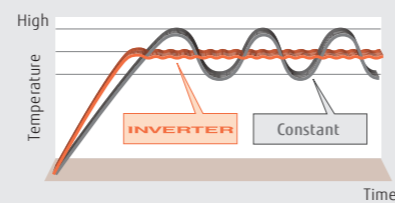

High-durability coaxial heat exchanger

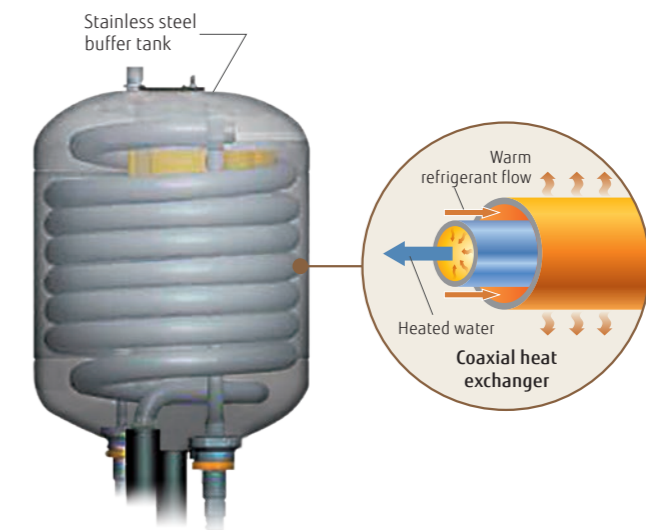

For Hydraulic unit

Stainless steel buffer tank

Heat exchange amount is 25% higher than the previous model. Energy-saving performance has also been improved.

- Anti-corrosion protection
- No flow switch required
- Anti-freeze protection not required

Class A Pump

Energy-saving pump with the ability to adjust the flow rate and pressure to a constant level



Split Type Comfort Series



Hydraulic unit:
WSYA050ML3 / WSYA080ML3 /
WSYA100ML3
Outdoor unit:
WOYA060KLT / Woya080KLT /
WOYA100KLT



Specifications

Model Name	Hydraulic unit		WSYA050ML3		WSYA080ML3		WSYA080ML3		WSYA100ML3	
	Outdoor unit		WOYA060KLT		WOYA060KLT		WOYA080KLT		WOYA100KLT	
Capacity Range			5		6		8		10	
7°C/35°C floor heating *1	Heating capacity	kW	4.50		5.50		7.50		9.50	
	Input power		0.949		1.18		1.69		2.11	
	COP		4.74		4.65		4.43		4.50	
2°C/35°C floor heating *1	Heating capacity	kW	4.50		5.30		6.30		9.30	
	Input power		1.33		1.65		1.96		3.08	
	COP		3.39		3.22		3.21		3.02	
-7°C/35°C floor heating *1	Heating capacity	kW	4.40		5.00		5.70		8.90	
	Input power		1.59		1.90		2.13		3.36	
	COP		2.76		2.63		2.68		2.65	
-7°C/55°C Radiator *1	Heating capacity	kW	3.90		4.25		5.30		8.00	
	Input power		2.11		2.25		2.79		4.10	
	COP		1.85		1.89		1.90		1.95	

Space heating characteristics*2

Temperature application	°C	55	35	55	35	55	35	55	35
Energy efficiency class		A++	A+++	A++	A+++	A++	A+++	A++	A+++
Rated heat output (P _{rated})	kW	5	5	5	5	6	7	8	9
Seasonal space heating energy efficiency (η _s)	%	125	175	125	175	128	177	130	178
Annual energy consumption	kWh	3,035	2,322	3,411	2,594	3,903	2,982	5,083	3,875
Sound power level*3	Hydraulic unit	40		40		40		40	
	Outdoor unit	57		57		60		62	

Hydraulic unit specifications

Power source	Single phase, ~230 V, 50 Hz								
Dimensions H × W × D	mm	847 × 450 × 493		847 × 450 × 493		847 × 450 × 493		847 × 450 × 493	
Weight (Net)	kg	47		47		47		47	
Water circulation	Min./Max.	L/min		7.6/22.0		8.5/22.0		10.0/22.0	
Buffer tank capacity	L	16		16		16		16	
Expansion vessel capacity	L	8		8		8		8	
Water flow temperature range	Max.	°C		55		55		55	
Water pipe connection diameter	Flow/Return	mm		Ø25.4/Ø25.4		Ø25.4/Ø25.4		Ø25.4/Ø25.4	
Backup heater	Capacity	kW		3.0		3.0		3.0	

Outdoor unit specifications

Power source	Single phase, ~230 V, 50 Hz									
Current	Max.	A		13.0		18.0		19.0		
Dimensions H × W × D	mm	632 × 799 × 290		632 × 799 × 290		716 × 820 × 315		998 × 940 × 320		
Weight (Net)	kg	39		39		42		62		
Refrigerant	Type (Global Warming Potential)	R32 (675)		R32 (675)		R32 (675)		R32 (675)		
	Charge	kg		0.97		1.02		1.63		
Additional refrigerant charge		g/m		25		25		20		
	Diameter	Liquid	mm		6.35		6.35		9.52	
Connection pipe	Gas	mm		12.70		12.70		15.88		
	Length	Min./Max.	m		3/30		3/30		3/30	
	Length (Pre-charge)	m		15		15		20		
	Height difference	Max.	m		20		20		20	
Operating range	Heating	°C		-20 to 35		-20 to 35		-20 to 35		

*1: Heating capacity, input power, and COP are measured using the EN14511 standard. Actual usage environments, such as the operating modes of the heating equipment, room temperature, and controller settings, may cause differences in values between those listed in the catalog and the actual performance characteristics.

*2: Information about ErP can be downloaded from our website at www.fujitsu-general.com/global/support/downloads/search/

*3: The sound power level values are based on EN12102 standard measurements under EN14825 standard conditions.

Dimensions

(Unit: mm)

Outdoor unit:
WOYA060KLT

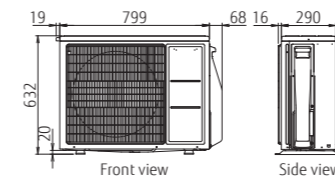

WOYA080KLT

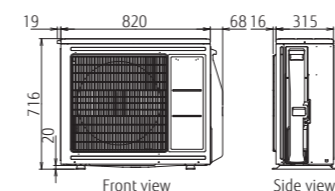

WOYA100KLT

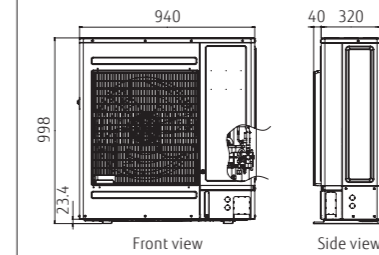

Hydraulic unit:
WSYA050ML3/WSYA080ML3/WSYA100ML3

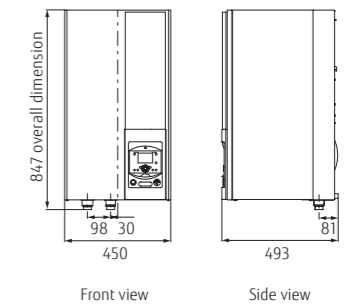

High water flow temperature

The temperature of water flow is up to 55°C without a backup heater. Hot water supply temperature can be maintained even at -10°C outdoor temperature.

* If you want to raise the temperature of the water supply to above the maximum temperature, use a backup heater to supplement the primary heater.



High COP

Heat pumps of ATW Systems work more efficiently and consume less energy than conventional heating systems.

Energy efficiency class



*Temperature application: Heating temp. 35°C

Seasonal space heating energy efficiency (η_s)

Conditions: Outdoor Temp. 7°C Heating Temp. 35°C

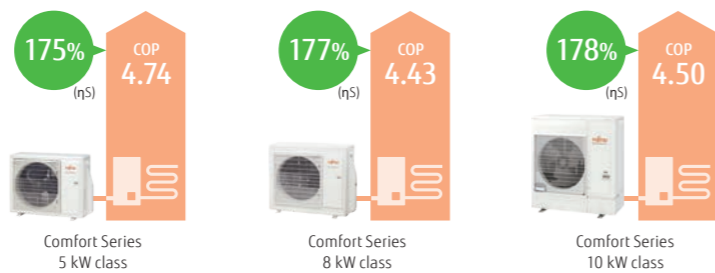

Outdoor unit technology



DC Fan Motor
High-performance, high-efficiency small DC fan motor mounted

DC Twin-Rotary Compressor
High-efficiency DC twin-rotary compressor

DC Inverter
DC inverter provides smooth water temperature control.

Split Type

Super High Power Series



High water flow temperature

The temperature of water flow can be maintained at 60°C without using a backup heater, even when the outdoor temperature drops to -20°C. The system can supply 55°C water without a backup heater at an outdoor temperature of -22°C.

* If you want to raise the temperature of the water supply to above the maximum temperature, use a backup heater to supplement the primary heater.

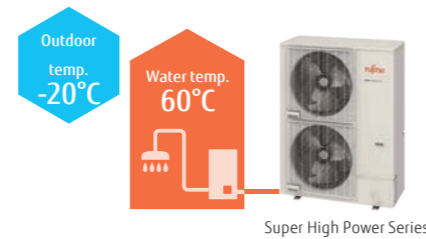

High COP

Heat pumps of ATW Systems work more efficiently and consume less energy than conventional heating systems.

Energy efficiency class **A++**

Seasonal space heating energy efficiency (η_s)

Conditions: Outdoor Temp. 7°C Heating Temp. 35°C

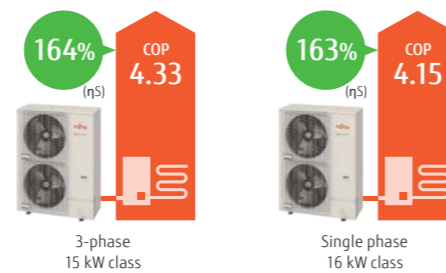

Operating range extended to -25°C

Operating range improved down to -25°C outdoor temperature



Hydraulic unit:
WSYG160DJ6 / [3-phase] WSYK170DJ9
Outdoor unit:
WOYG160LJL
[3-phase] WOYK150LJL / WOYK170LJL



Specifications

Model Name	Hydraulic unit	Outdoor unit	WSYG160DJ6	WSYK170DJ9	WSYK170DJ9			
Capacity range			16	15	17			
7°C/35°C floor heating *1	Heating capacity	kW	16.00	15.00	17.00			
	Input power		3.86	3.46	4.10			
	COP		4.15	4.33	4.15			
2°C/35°C floor heating *1	Heating capacity	kW	13.30	13.20	13.50			
	Input power		4.25	4.06	4.27			
	COP		3.13	3.25	3.16			
-7°C/35°C floor heating*1	Heating capacity	kW	14.50	13.20	15.00			
	Input power		5.27	4.55	5.32			
	COP		2.75	2.90	2.82			
-7°C/55°C Radiator*1	Heating capacity	kW	10.90	13.20	14.20			
	Input power		5.89	6.77	7.40			
	COP		1.85	1.95	1.92			
Space heating characteristics*2								
Temperature application	°C		55	35	55	35	55	35
Energy efficiency class			A++	A++	A++	A++	A++	A++
Rated heat output (P _{rated})	kW		14	16	16	17	17	18
Seasonal space heating energy efficiency (η _s)	%		125	163	130	164	130	161
Annual energy consumption	kWh		8,757	8,014	9,915	8,606	10,232	9,059
Sound power level	Hydraulic unit	dB(A)	45	45	45	45	45	45
	Outdoor unit		67	66	67	66	67	68
Hydraulic unit specifications								
Power source			Single phase, ~230 V, 50 Hz		3-phase, ~400 V, 50 Hz			
Dimensions H × W × D	mm		805 × 450 × 471		805 × 450 × 471			
Weight (Net)	kg		52.5		52.5			
Water circulation	Min./Max.	L/min	26.4/57.8		24.0/54.2			
Buffer tank capacity	L		22		22			
Expansion vessel capacity	L		10		10			
Water flow temperature range	Max.	°C	60		60			
Water pipe connection diameter	Flow/Return	mm	Ø25.4/Ø25.4		Ø25.4/Ø25.4			
Backup heater	Capacity	kW	6.0 (3.0 kW × 2 pcs.)		9.0 (3.0 kW × 3 pcs.)			
Outdoor unit specifications								
Power source			Single phase, ~230 V, 50 Hz		3-phase, ~400 V, 50 Hz			
Current	Max.	A	28.0		14.0			
Dimensions H × W × D	mm		1,428 × 1,080 × 480		1,428 × 1,080 × 480			
Weight (Net)	kg		137		138			
Refrigerant	Type (Global Warming Potential)	R410A (2,088)						
Additional refrigerant charge	Charge	kg	3.80		3.80			
		g/m	50		50			
Connection pipe	Diameter	Liquid	Ø9.52		Ø9.52			
		Gas	Ø15.88		Ø15.88			
	Length	Min./Max.	5/30		5/30			
		Length (Pre-charge)	15		15			
Height difference	Max.	25/15 (Outdoor unit: Upper/Lower)						
Operating range	Heating	°C	-25 to 35		-25 to 35			

*1: Heating capacity, input power, and COP are measured using the EN14511 standard. Actual usage environments, such as the operating modes of the heating equipment, room temperature, and controller settings, may cause differences in values between those listed in the catalog and the actual performance characteristics.

*2: Information about ErP can be downloaded from our website at www.fujitsu-general.com/global/support/downloads/search/

Dimensions

(Unit: mm)

Outdoor unit:
Single phase: WOYG160LJL
3-phase: WOYK150LJL/WOYK170LJL

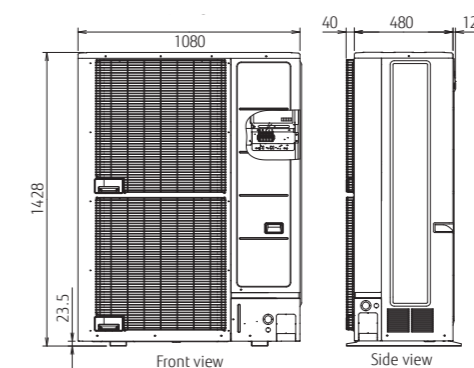

Hydraulic unit:
Single phase: WSYG160DJ6
3-phase: WSYK170DJ9

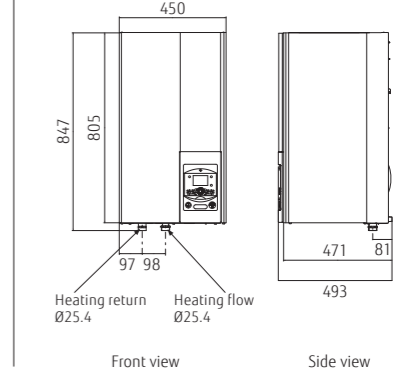

Split Type High Power Series



High water flow temperature

The temperature of water flow can be maintained at 60°C without using a backup heater, even when the outdoor temperature drops to -20°C.

* If you want to raise the temperature of the water supply to above the maximum temperature, use a backup heater to supplement the primary heater.



High COP

Heat pumps of ATW Systems work more efficiently and consume less energy than conventional heating systems.

Energy efficiency class **A++***

*Temperature application: Heating temp. 35°C

Seasonal space heating energy efficiency (η_s)

Conditions: Outdoor Temp. 7°C Heating Temp. 35°C

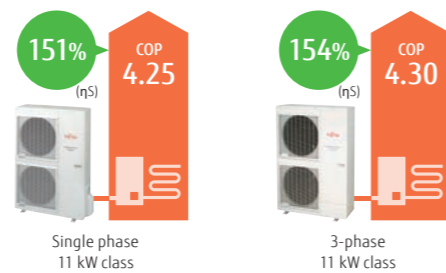

Hydraulic unit:
WSYG140DG6 / [3-phase] WSYK160DG9
Outdoor unit:
WOYG112LHT / WOYG140LCTA
[3-phase] WOYK112LCTA / WOYK140LCTA /
WOYK160LCTA



Specifications

Model Name	Hydraulic unit		WSYG140DG6		WSYG140DG6		WSYK160DG9		WSYK160DG9		WSYK160DG9	
	Outdoor unit		WOYG112LHT	WOYG140LCTA	WOYK112LCTA	WOYK140LCTA	WOYK140LCTA	WOYK160LCTA	WOYK160LCTA	WOYK160LCTA	WOYK160LCTA	WOYK160LCTA
Capacity range			11	14	11	14	11	14	14	16		
7°C/35°C floor heating *1	Heating capacity	kW	10.80	13.50	10.80	13.50	10.80	13.50	13.50	15.17		
	Input power		2.54	3.23	2.51	3.20	2.51	3.20	3.70			
	COP		4.25	4.18	4.30	4.22	4.30	4.22	4.10			
2°C/35°C floor heating *1	Heating capacity	kW	10.77	12.00	10.77	13.00	10.77	13.00	13.50			
	Input power		3.44	3.87	3.40	4.15	3.40	4.15	4.34			
	COP		3.13	3.10	3.17	3.13	3.13	3.13	3.11			
-7°C/35°C floor heating*1	Heating capacity	kW	10.38	11.54	10.38	12.20	10.38	12.20	13.50			
	Input power		4.32	5.08	4.28	5.13	4.28	5.13	5.40			
	COP		2.40	2.27	2.43	2.38	2.43	2.38	2.50			
-7°C/55°C Radiator*1	Heating capacity	kW	7.57	9.20	7.27	10.10	7.27	10.10	11.00			
	Input power		4.57	5.08	5.09	5.65	5.09	5.65	6.29			
	COP		1.66	1.81	1.82	1.79	1.82	1.79	1.75			

Space heating characteristics*2

Temperature application	°C	55	35	55	35	55	35	55	35	55	35
Energy efficiency class		A+	A++	A+	A+	A+	A++	A+	A++	A+	A+
Rated heat output (P _{rated})	kW	9	11	11	13	9	11	11	13	13	14
Seasonal space heating energy efficiency (η _s)	%	112	151	113	148	112	154	117	150	117	149
Annual energy consumption	kWh	6,704	6,062	8,041	6,824	6,669	5,930	7,803	6,738	9,062	7,408
Sound power level	Hydraulic unit	46		46		46		46		46	
	Outdoor unit	68		69		69		68		71	

Hydraulic unit specifications

Power source	Single phase, ~230 V, 50 Hz				3-phase, ~400 V, 50 Hz			
Dimensions H × W × D	800 × 450 × 457				800 × 450 × 457			
Weight (Net)	42				42			
Water circulation	Min./Max.	L/min	19.5/39.0	24.4/48.7	19.5/39.0	24.4/48.7	27.4/54.8	
Buffer tank capacity	L		16		16		16	
Expansion vessel capacity	L		8		8		8	
Water flow temperature range	Max.	°C	60		60		60	
Water pipe connection diameter	Flow/Return	mm	Ø25.4/Ø25.4		Ø25.4/Ø25.4		Ø25.4/Ø25.4	
Backup heater	Capacity	kW	6.0 (3.0 kW × 2 pcs.)		9.0 (3.0 kW × 3 pcs.)			

Outdoor unit specifications

Power source	Single phase, ~230 V, 50 Hz				3-phase, ~400 V, 50 Hz				
Current	Max.	A	22.0	25.0	9.0	9.5	10.5		
Dimensions H × W × D	mm				1,290 × 900 × 330				
Weight (Net)	kg				92				
Refrigerant	Type (Global Warming Potential)	R410A (2,088)							
	Charge	kg	2.50						
Additional refrigerant charge		g/m	50						
	Diameter	Liquid	mm						
Connection pipe	Gas	mm							
	Length	Min./Max.	m						
	Length (Pre-charge)		m						
Height difference	Max.	m							
			m						
Operating range	Heating	°C							
		-25 to 35							

*1: Heating capacity, input power, and COP are measured using the EN14511 standard. Actual usage environments, such as the operating modes of the heating equipment, room temperature, and controller settings, may cause differences in values between those listed in the catalog and the actual performance characteristics.

*2: Information about ErP can be downloaded from our website at www.fujitsu-general.com/global/support/downloads/search/

Dimensions

(Unit: mm)

Outdoor unit:
Single phase: WOYG112LHT/WOYG140LCTA

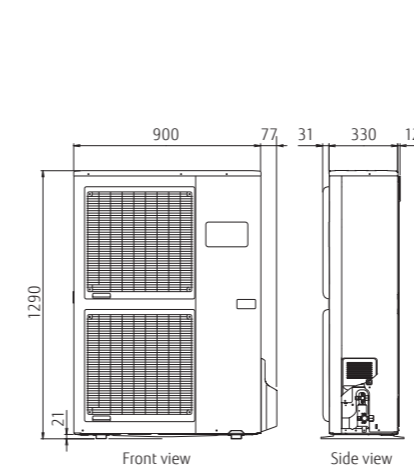

3-phase: WOYK112LCTA/WOYK140LCTA/WOYK160LCTA

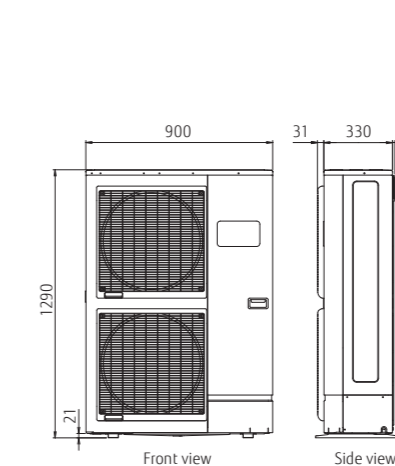

Hydraulic unit:
Single phase: WSYG140DG6
3-phase: WSYK160DG9

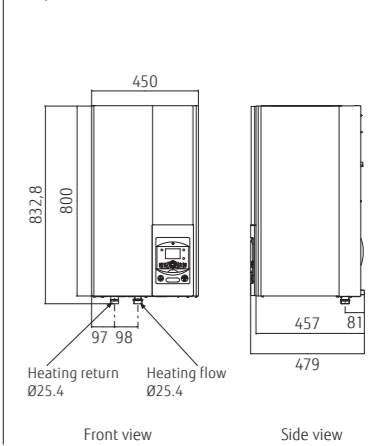

Split DHW Integrated Type

Comfort Series



Hydraulic unit:
WGYA050ML3 / WGYA080ML3 / WGYA100ML3
Outdoor unit:
WOYA060KLT / Woya080KLT / Woya100KLT



Specifications

Model Name	Hydraulic unit	WGYA050ML3	WGYA080ML3	WGYA080ML3	WGYA100ML3				
	Outdoor unit	WOYA060KLT	WOYA060KLT	WOYA080KLT	WOYA100KLT				
Capacity range		5	6	8	10				
7°C/35°C floor heating *1	Heating capacity	4.50	5.50	7.50	9.50				
	Input power	0.949	1.18	1.69	2.11				
	COP	4.74	4.65	4.43	4.50				
2°C/35°C floor heating *1	Heating capacity	4.50	5.30	6.30	9.30				
	Input power	1.33	1.65	1.96	3.08				
	COP	3.39	3.22	3.21	3.02				
-7°C/35°C floor heating *1	Heating capacity	4.40	5.00	5.70	8.90				
	Input power	1.59	1.90	2.13	3.36				
	COP	2.76	2.63	2.68	2.65				
-7°C/55°C Radiator *1	Heating capacity	3.90	4.25	5.30	8.00				
	Input power	2.11	2.25	2.79	4.10				
	COP	1.85	1.89	1.90	1.95				
Space heating characteristics**									
Temperature application	°C	55	35	55	35	55	35	55	35
Energy efficiency class		A++	A+++	A++	A+++	A++	A+++	A++	A+++
Rated heat output (P _{rated})	kW	5	5	5	6	6	7	8	9
Seasonal space heating energy efficiency (η _s)	%	125	175	125	175	128	177	130	178
Annual energy consumption	kWh	3,035	2,322	3,411	2,594	3,903	2,982	5,083	3,875
Sound power level*3	Hydraulic unit	40	-	40	-	40	-	40	-
	Outdoor unit	57	-	57	-	60	-	62	-
Domestic hot water characteristics**									
Load profile		L	L	L	L	L	L	L	L
Energy efficiency class		A+	A+	A+	A+	A+	A+	A+	A+
Energy efficiency (η _{wh})	%	130	130	130	130	130	130	130	130
Annual electricity consumption	kWh	793	793	793	793	793	793	793	793
Hydraulic unit specifications									
Power source		Single phase, ~230 V, 50 Hz							
Dimensions H × W × D	mm	1,863 × 648 × 700	1,863 × 648 × 700	1,863 × 648 × 700	1,863 × 648 × 700				
Weight (Net)	kg	145	145	145	145				
Water circulation	Min./Max. L/min	7.6/22.0	8.5/22.0	10.0/22.0	13.2/30.0				
DHW capacity	L	190	190	190	190				
Electrical heater capacity	Heating	3.0	3.0	3.0	3.0				
	DHW	1.5	1.5	1.5	1.5				
Buffer tank capacity	L	16	16	16	16				
Expansion vessel capacity	L	8	8	8	8				
Water flow temperature range	Max. °C	55	55	55	55				
Water pipe connection diameter	Flow/Return mm	Ø25.4/Ø25.4	Ø25.4/Ø25.4	Ø25.4/Ø25.4	Ø25.4/Ø25.4				
Hot water pipe connection diameter	mm	Ø19.05	Ø19.05	Ø19.05	Ø19.05				
Outdoor unit specifications									
Power source		Single phase, ~230 V, 50 Hz							
Current	Max. A	13.0	13.0	18.0	19.0				
Dimensions H × W × D	mm	632 × 799 × 290	632 × 799 × 290	716 × 820 × 315	998 × 940 × 320				
Weight (Net)	kg	39	39	42	62				
Refrigerant	Type (Global Warming Potential)	R32 (675)							
	Charge	kg	0.97	0.97	1.02	1.63			
Additional refrigerant charge		g/m	25	25	20				
	Diameter	Liquid	6.35	6.35	6.35	9.52			
Connection pipe		Gas	12.70	12.70	12.70	15.88			
	Length	Min./Max.	m	3/30	3/30	3/30			
	Length (Pre-charge)	m	15	15	15	20			
	Height difference	Max.	m	20	20	20			
Operating range	Heating	°C	-20 to 35	-20 to 35	-20 to 35	-20 to 35			

High water flow temperature

The temperature of water flow is up to 55°C without a backup heater. Hot water supply temperature can be maintained even at -10°C outdoor temperature.

* If you want to raise the temperature of the water supply to above the maximum temperature, use a backup heater to supplement the primary heater.



High COP

Heat pumps of ATW Systems work more efficiently and consume less energy than conventional heating systems.

Energy efficiency class **A+++***

*Temperature application: Heating temp. 35°C

Seasonal space heating energy efficiency (η_s)
Conditions: Outdoor Temp. 7°C Heating Temp. 35°C

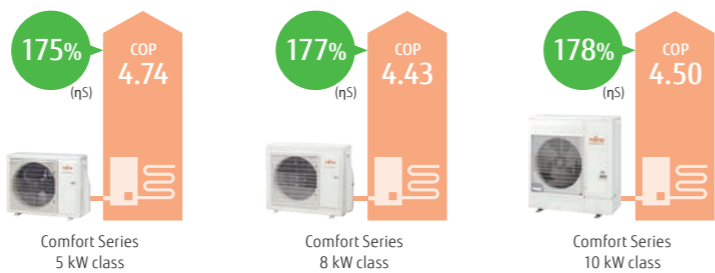

Outdoor unit technology



DC Fan Motor
High-performance, high-efficiency small DC fan motor mounted

DC Twin-Rotary Compressor
High-efficiency DC twin-rotary compressor

DC Inverter
DC inverter provides smooth water temperature control.

*1: Heating capacity, input power, and COP are measured using the EN14511 standard. Actual usage environments, such as the operating modes of the heating equipment, room temperature, and controller settings, may cause differences in values between those listed in the catalog and the actual performance characteristics.
*2: Information about ErP can be downloaded from our website at www.fujitsu-general.com/global/support/downloads/search/
*3: The sound power level values are based on EN12102 standard measurements under EN14825 standard conditions.

Dimensions

(Unit: mm)

Outdoor unit:
WOYA060KLT

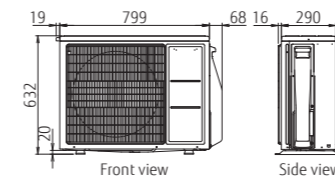

WOYA080KLT

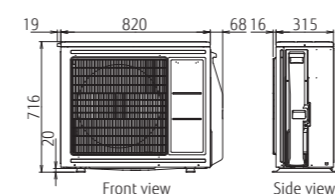

WOYA100KLT

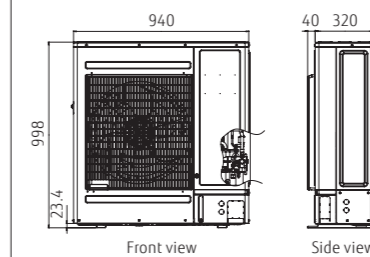

Hydraulic unit:
WGYA050ML3/WGYA080ML3/WGYA100ML3

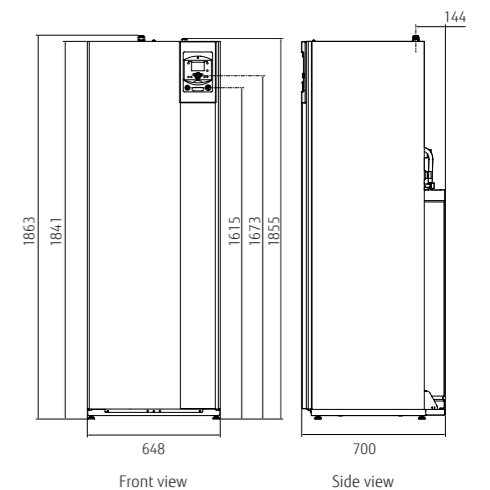

Split DHW Integrated Type

Super High Power Series



High water flow temperature

The temperature of water flow can be maintained at 60°C without using a backup heater, even when the outdoor temperature drops to -20°C. The system can supply 55°C water without a backup heater at an outdoor temperature of -22°C.

* If you want to raise the temperature of the water supply to above the maximum temperature, use a backup heater to supplement the primary heater.

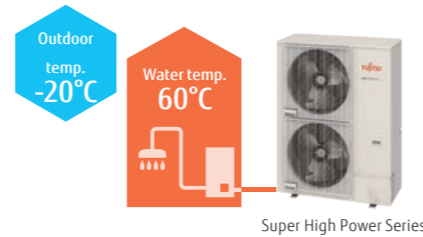

High COP

Heat pumps of ATW Systems work more efficiently and consume less energy than conventional heating systems.



Seasonal space heating energy efficiency (η_s)

Conditions: Outdoor Temp. 7°C Heating Temp. 35°C

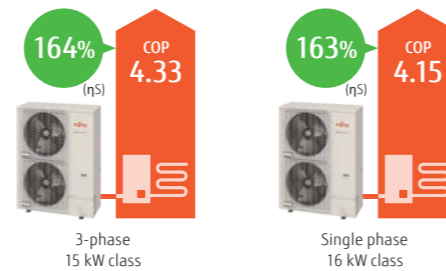

Operating range extended to -25°C

Operating range improved down to -25°C outdoor temperature

Stylish space saving solution with **Built-in High-performance DHW tank 190 L**

- Coil heat exchanger optimizes DHW supply performance.
- Temperature rises quickly due to the large surface of the exchanger.

Hydraulic unit:
WGYG160DJ6 / [3-phase] WGYK170DJ9
Outdoor unit:
WOYG160LJL
[3-phase] WOYK150LJL / WOYK170LJL



Specifications

Model Name	Hydraulic unit	WGYG160DJ6	WGYK170DJ9	WGYK170DJ9
Capacity range	Outdoor unit	WOYG160LJL	WOYK150LJL	WOYK170LJL
7°C/35°C floor heating *1	Heating capacity	16.00	15.00	17.00
	Input power	3.86	3.46	4.10
	COP	4.15	4.33	4.15
2°C/35°C floor heating *1	Heating capacity	13.30	13.20	13.50
	Input power	4.25	4.06	4.27
	COP	3.13	3.25	3.16
-7°C/35°C floor heating *1	Heating capacity	14.50	13.20	15.00
	Input power	5.27	4.55	5.32
	COP	2.75	2.90	2.82
-7°C/55°C Radiator *1	Heating capacity	10.90	13.20	14.20
	Input power	5.89	6.77	7.40
	COP	1.85	1.95	1.92
Space heating characteristics**				
Temperature application	°C	55	35	55
Energy efficiency class		A++	A++	A++
Rated heat output (P _{rated})	kW	14	16	17
Seasonal space heating energy efficiency (η _s)	%	125	163	130
Annual energy consumption	kWh	8,757	8,014	9,915
Sound power level	dB(A)	45	45	45
	Outdoor unit	67	66	67
Domestic hot water characteristics**				
Load profile			L	
Energy efficiency class			A	
Energy efficiency (η _{DHW})	%		109	
Annual electricity consumption	kWh		941	
Hydraulic unit specifications				
Power source		Single phase, ~230 V, 50 Hz	3-phase, ~400 V, 50 Hz	
Dimensions H × W × D	mm		1,841 × 648 × 698	
Weight (Net)	kg		166	
Water circulation	Min./Max. L/min	26.4/57.8	24.0/54.2	27.3/61.4
DHW capacity	L		190	
Electrical heater capacity	Heating kW	6.0 (3.0 kW × 2 pcs.)	9.0 (3.0 kW × 3 pcs.)	
	DHW		1.5	
Buffer tank capacity	L		22	
Expansion vessel capacity	L		12	
Water flow temperature range	Max. °C		60	
Water pipe connection diameter	Flow/Return mm		Ø25.4/Ø25.4	
Hot water pipe connection diameter	mm		Ø19.05	
Outdoor unit specifications				
Power source		Single phase, ~230 V, 50 Hz	3-phase, ~400 V, 50 Hz	
Current	Max. A	28.0	14.0	
Dimensions H × W × D	mm	1,428 × 1,080 × 480	1,428 × 1,080 × 480	
Weight (Net)	kg	137	138	
Refrigerant	Type (Global Warming Potential)	R410A (2.088)	R410A (2.088)	
Additional refrigerant charge	Charge	3.80	3.80	
	q/m	50	50	
Connection pipe	Diameter	Liquid	Ø9.52	
		Gas	Ø15.88	
	Length	Min./Max.	5/30	
	Length (Pre-charge)	m	15	
Height difference	Max. m	25/15 (Outdoor unit: Upper/Lower)	25/15 (Outdoor unit: Upper/Lower)	
Operating range	Heating °C	-25 to 35	-25 to 35	

*1: Heating capacity, input power, and COP are measured using the EN14511 standard. Actual usage environments, such as the operating modes of the heating equipment, room temperature, and controller settings, may cause differences in values between those listed in the catalog and the actual performance characteristics.

*2: Information about ErP can be downloaded from our website at www.fujitsu-general.com/global/support/downloads/search/

Dimensions

(Unit: mm)

Outdoor unit:
Single phase: WOYG160LJL
3-phase: WOYK150LJL/WOYK170LJL

Hydraulic unit:
Single phase: WGYG160DJ6
3-phase: WGYK170DJ9

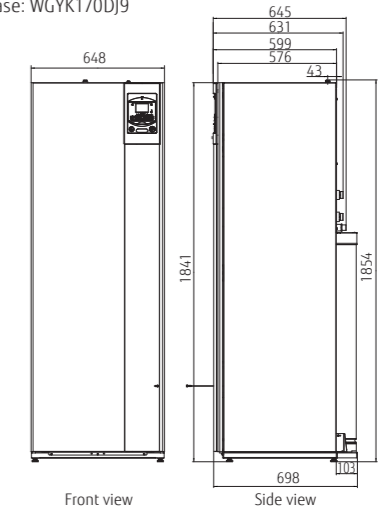
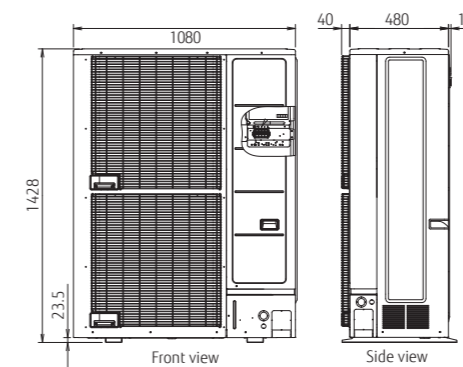

Split DHW Integrated Type

High Power Series



High water flow temperature

The temperature of water flow can be maintained at 60°C without using a backup heater, even when the outdoor temperature drops to -20°C.

* If you want to raise the temperature of the water supply to above the maximum temperature, use a backup heater to supplement the primary heater.



High COP

Heat pumps of ATW Systems work more efficiently and consume less energy than conventional heating systems.

Energy efficiency class **A++***

*Temperature application: Heating temp. 35°C

Seasonal space heating energy efficiency (η_s)

Conditions: Outdoor Temp. 7°C Heating Temp. 35°C

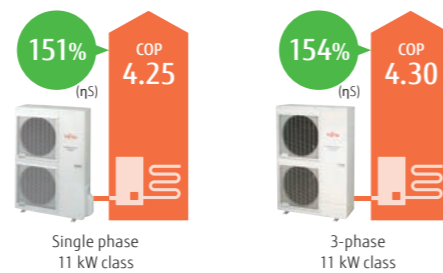

Optimized refrigerant cycle operation

The High Power Series deliver high performance and efficiency with twin sensors and hot water heating technology.

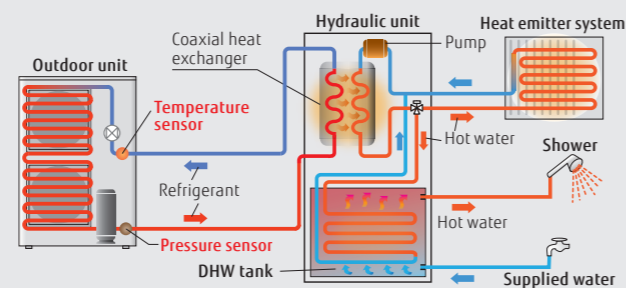

Hydraulic unit:
WGYG140DG6 / [3-phase] WGYK160DG9
Outdoor unit:
WOYG112LHT / WOYG140LCTA
[3-phase] WOYK112LCTA / WOYK140LCTA / WOYK160LCTA



Hydraulic unit
Single phase/
3-phase



Outdoor unit
Single phase
11/14 kW



Outdoor unit
3-phase
11/14/16 kW

Specifications

Model Name	Hydraulic unit		WGYG140DG6		WGYG140DG6		WGYK160DG9		WGYK160DG9		WGYK160DG9		
	Outdoor unit		WOYG112LHT	WOYG140LCTA	WOYG112LCTA	WOYG140LCTA	WOYK112LCTA	WOYK140LCTA	WOYK112LCTA	WOYK140LCTA	WOYK160LCTA	WOYK160LCTA	
Capacity range			11	14	11	14	11	14	11	14	16		
7°C/35°C floor heating *1	Heating capacity	kW	10.80	13.50	10.80	13.50	10.80	13.50	10.80	13.50	15.17		
	Input power		2.54	3.23	2.51	3.20	2.51	3.20	2.51	3.20	3.70		
	COP		4.25	4.18	4.30	4.22	4.30	4.22	4.30	4.22	4.10		
2°C/35°C floor heating *1	Heating capacity	kW	10.77	12.00	10.77	12.00	10.77	12.00	10.77	12.00	13.50		
	Input power		3.44	3.87	3.40	4.15	3.40	4.15	3.40	4.15	4.34		
	COP		3.13	3.10	3.17	3.13	3.17	3.13	3.17	3.13	3.11		
-7°C/35°C floor heating*1	Heating capacity	kW	10.38	11.54	10.38	11.54	10.38	11.54	10.38	11.54	13.50		
	Input power		4.32	5.08	4.28	5.13	4.28	5.13	4.28	5.13	5.40		
	COP		2.40	2.27	2.43	2.38	2.43	2.38	2.43	2.38	2.50		
-7°C/55°C Radiator*1	Heating capacity	kW	7.57	9.20	7.57	9.20	7.57	9.20	7.57	9.20	11.00		
	Input power		4.57	5.08	4.57	5.08	4.57	5.08	4.57	5.08	6.29		
	COP		1.66	1.81	1.66	1.81	1.66	1.81	1.66	1.81	1.75		
Space heating characteristics*2													
Temperature application	°C		55	35	55	35	55	35	55	35	55	35	
Energy efficiency class			A+	A++	A+	A+	A+	A++	A+	A++	A+	A+	
Rated heat output (P _{rated})	kW		9	11	11	13	9	11	11	13	13	14	
Seasonal space heating energy efficiency (η _s)	%		112	151	113	148	112	154	117	150	117	149	
Annual energy consumption	kWh		6,704	6,062	8,041	6,824	6,669	5,930	7,803	6,738	9,062	7,408	
Sound power level	Hydraulic unit	dB(A)	46		46		46		46		46		
	Outdoor unit		68		69		69		68		71		
Domestic hot water characteristics*2													
Load profile	L												
Energy efficiency class	A												
Energy efficiency (η _{wh})	88												
Annual electricity consumption	kWh												
Hydraulic unit specifications													
Power source	Single phase, ~230 V, 50 Hz						3-phase, ~400 V, 50 Hz						
Dimensions H × W × D	mm						1,840 × 648 × 698						
Weight (Net)	kg						152						
Water circulation	Min./Max.	L/min		19.5/39.0		24.4/28.7		19.5/39.0		24.4/48.7		27.4/54.8	
DHW capacity	L												
Electrical heater capacity	Heating	kW						6.0 (3.0 kW × 2 pcs.)					
	DHW	kW						9.0 (3.0 kW × 3 pcs.)					
Buffer tank capacity	L												
Expansion vessel capacity	L												
Water flow temperature range	Max.	°C											
Water pipe connection diameter	Flow/Return	mm											
Hot water pipe connection diameter	mm												
Outdoor unit specifications													
Power source	Single phase, ~230 V, 50 Hz						3-phase, ~400 V, 50 Hz						
Current	Max.	A		22.0		25.0		9.0		9.5		10.5	
Dimensions H × W × D	mm						1,290 × 900 × 330						
Weight (Net)	kg						92						
Refrigerant	Type (Global Warming Potential)	R410A (2,088)											
Additional refrigerant charge	Charge	kg		2.50		5.0		2.50		5.0		5.0	
		g/m		50		50		50		50		50	
Connection pipe	Diameter	Liquid	mm		Ø9.52		Ø15.88		Ø9.52		Ø15.88		
		Gas	mm		Ø15.88		Ø15.88		Ø15.88		Ø15.88		
	Length	Min./Max.	m		5/20		5/20		5/20		5/20		
	Length (Pre-charge)	m		15		15		15		15		15	
Operating range	Max.	m		15		15		15		15		15	
	Heating	°C		-25 to 35		-25 to 35		-25 to 35		-25 to 35		-25 to 35	

*1: Heating capacity, input power, and COP are measured using the EN14511 standard. Actual usage environments, such as the operating modes of the heating equipment, room temperature, and controller settings, may cause differences in values between those listed in the catalog and the actual performance characteristics.

*2: Information about ErP can be downloaded from our website at www.fujitsu-general.com/global/support/downloads/search/

Dimensions

(Unit: mm)

Outdoor unit:

Single phase: WOYG112LHT/WOYG140LCTA

3-phase: WOYK112LCTA/WOYK140LCTA/WOYK160LCTA

Hydraulic unit:

Single phase: WGYG140DG6
3-phase: WGYK160DG9

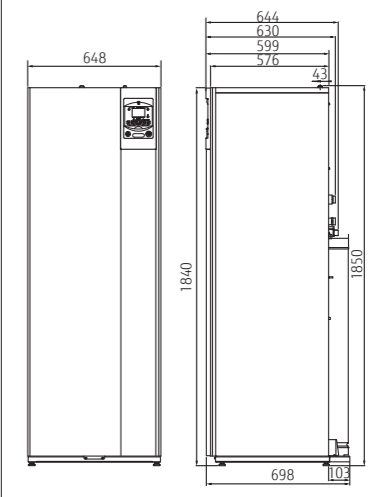
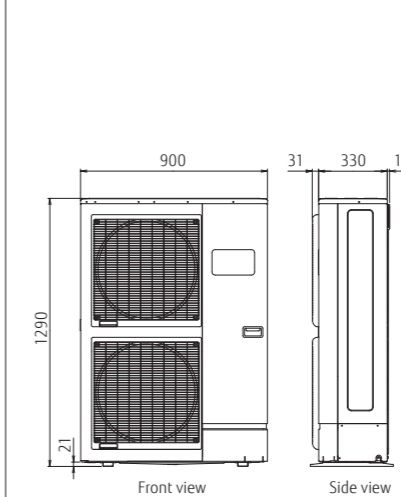
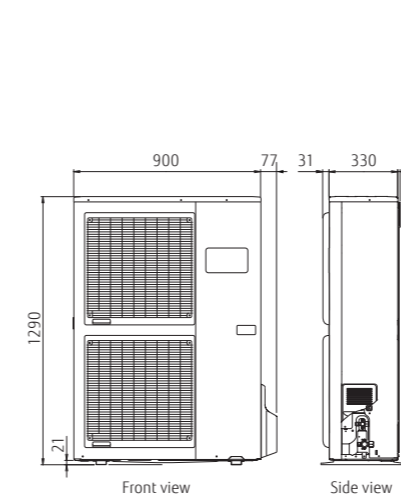

Comfort Control

The high-grade heating controller automatically adjusts the flow temperature according to the climate conditions to maintain the room and domestic hot water temperatures at the desired levels.

Hydraulic unit Controller 4 Heating modes

- 1. Automatic mode**
Enables automatic switching between Comfort mode and Reduce mode according to time program
- 2. Reduce mode**
Maintains water temperature at a lower level
- 3. Comfort mode**
Maintains water temperature at a comfortable level
- 4. Protection mode**
Activates frost protection in standby operation



Useful Features

Automatic heating curve control

Automatic temperature regulation according to heating curve (depending on heating terminal and outdoor temperature)

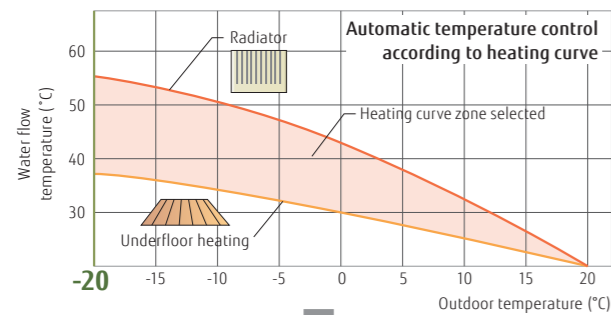

The heating curve will shift to adjust the room temperature setting.

Can be fine-adjusted when it is too warm or too cold.

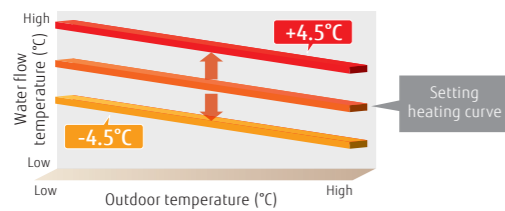

Quick recovery from defrosting

Maintains room temperature by boost start operation during defrosting.

Auto changeover

When cooling mode is selected, the system automatically switches between cooling and heating modes depending on the outdoor temperature to serve as an all-season air conditioner.

2-zone independent control

2-zone independent control (For example, the individual control of 2 underfloor heating zones or the combination of 1 underfloor heating zone and 1 radiator zone)*1

*1: Optional parts required

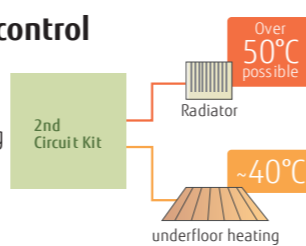

2-stage low-noise mode

The outdoor unit can be switched to quiet mode, depending on the installation environment.

*Effective only for High Power Series

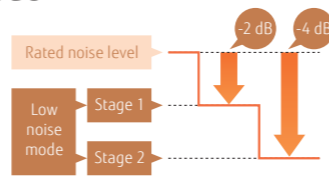

Backup heater operation

Backup heater maintains a comfortable room temperature even when the outside temperature is low. The backup heater is intelligently controlled as a safety backup for very cold days and nights, and only operates when really needed.

Energy Saving

Time program

- The timer is easy to set.
- You can select the heating mode in conjunction with various times of the day.

Day-weekly timer

- Allows up to 3 settings per day.
- Allows individual settings for each day of the week.

Holiday timer

- Allows up to 8 settings.
- While you are away from home for an extended period during winter, the system prevents your room or house from freezing.

Peak cut Function*2

Sets the peak current value to reduce power consumption.

Mode	Ratio to reduce power consumption
1	100%
2	75%
3	50%
4	Almost 0%

* Please refer to page W-038 and W-039 for optional parts information.

Safety Features

Anti-Legionella function

Prevents the growth of Legionella bacteria in the DHW tank to supply safe and clean hot water at all times.

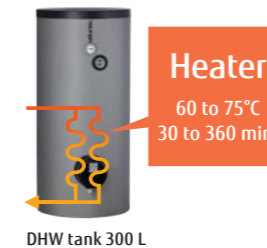

Anti-freeze function

When the outside temperature drops below a specified level, the compressor will self-activate and water will also be automatically circulated to prevent freezing.

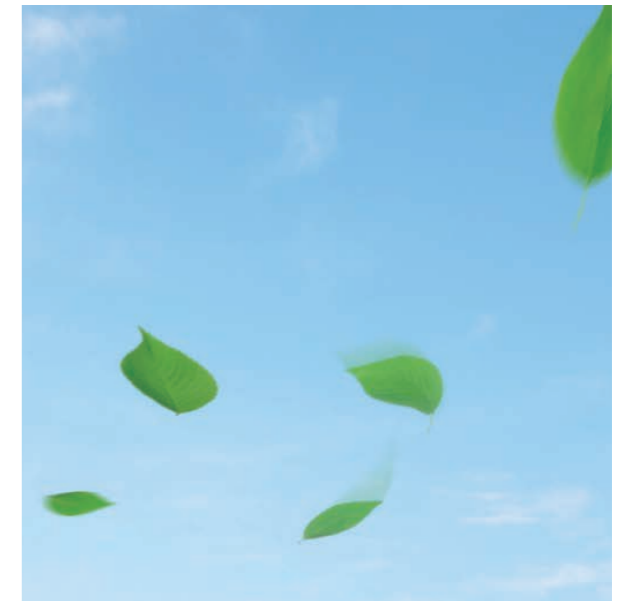
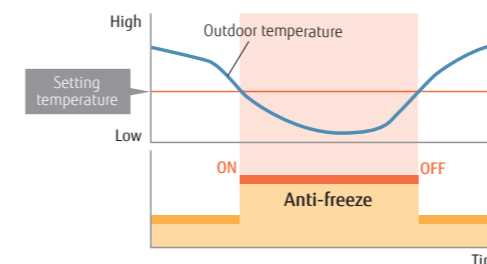

Emergency operation

If an outdoor unit fails to operate, a built-in backup heater or an external boiler is activated to supply an uninterrupted supply of hot water to the house.

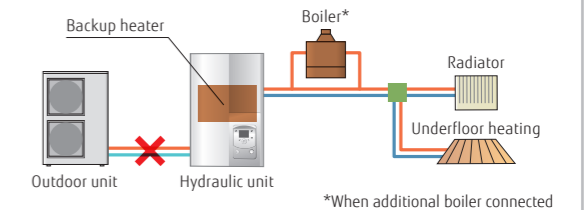

Error and Maintenance Alarm

Enables quick error-handling services and maintenance



- Error history saves 10 errors in memory
- Display telephone number of service company

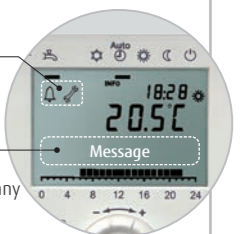

Simple installation

Presetting configurations

A controller installed makes it easy to configure the system without having to set each component or unit individually.

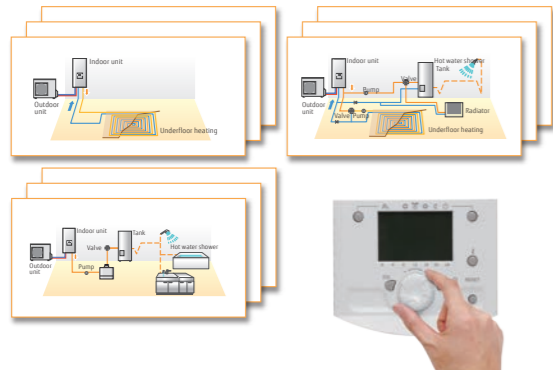

8 simple patterns for system presetting (Pair of heating: 12 patterns)

Configuration (Parameter 5700)	Installation type
Presetting 1	1 heating circuit
Presetting 2	2 heating circuits
Presetting 3	1 heating circuit with boiler backup
Presetting 4	2 heating circuits with boiler backup
Presetting 5	1/2 heating circuit with buffer control
Presetting 6	1/2 heating circuit with buffer control and boiler backup
Presetting 7	Cascade connection Primary
Presetting 8	Cascade connection A
Presetting 9	Cascade connection B/C

- DHW & solar control auto detection
- Cascade connection only available in High Power models.

Outdoor temperature simulation

It verifies that each unit operates properly under the set conditions and expected outdoor air temperature when the system is actually assembled.

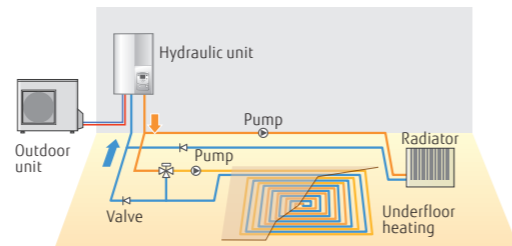

The outdoor temperatures can be simulated in the range of -50°C to +50°C.

Concrete floor drying

Allows the concrete surrounding the hot-water pipes to dry more quickly, shortening the construction period for underfloor heating installations.

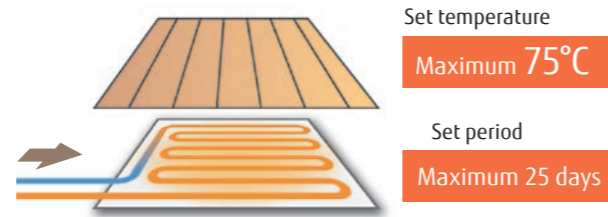

Controller with a large liquid crystal display and buttons for easy function setting

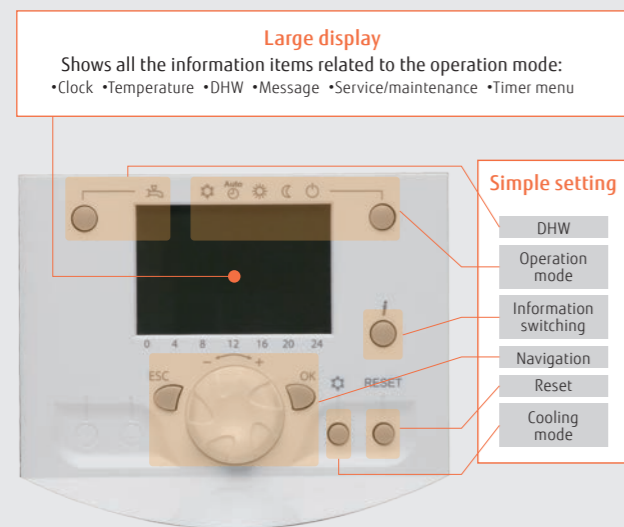

Main operation flow and settings for installers and end users

	Flow Chart	Example Item
Installers	1 Install Setting	Pump speed setting, Configuration, Heating curve setting, Heat pump shut off
	2 Option Setting	Cooling kit, DHW kit, Boiler kit
	3 Convenient Function	Automatic heating curve setting, Underfloor controlled driving, Outdoor temperature adjustment, Maintenance period setting
	4 Workout Setting	Outdoor temperature simulator
	5 Confirmation	Checking operation (Heating and cooling, DHW, option)
End users	6 User Setting	Date and time, Time program, Operation temperature setting

Easy Installation & Maintenance

- All hydraulic safety and control components are built in with no additional selection required.
- Lifting bars for installation free of difficulty or risk
- Easy access for maintenance
- Refrigerant pump down operation

Maintenance Support

Diagnostics functions for troubleshooting

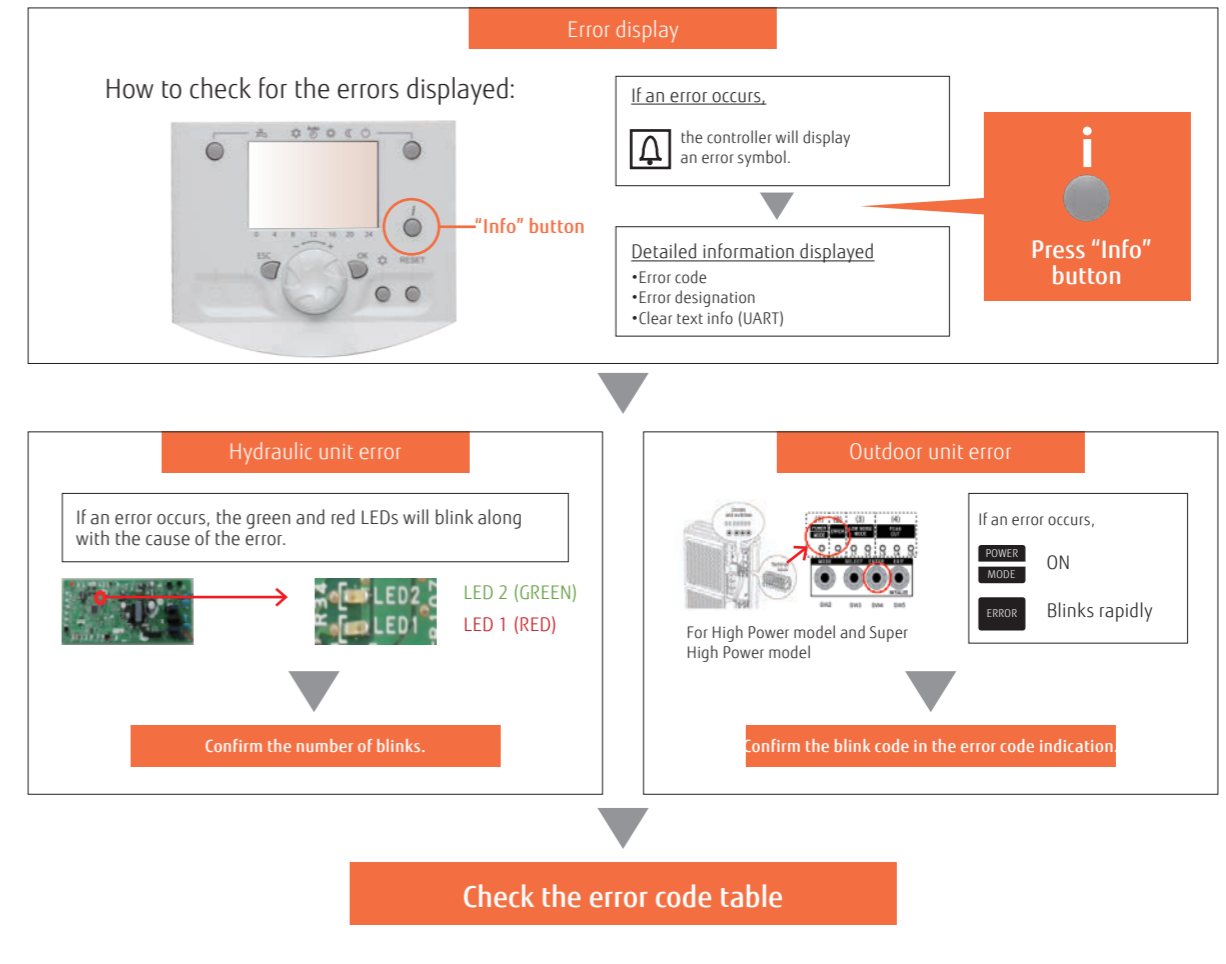

Installation requirements

Installation of equipment & electrical wiring

Split type Hydraulic unit

- The Hydraulic unit is hung on the wall.
- Weight ≤ 88 kg (including water)
- Space for maintenance needs to be taken into consideration.

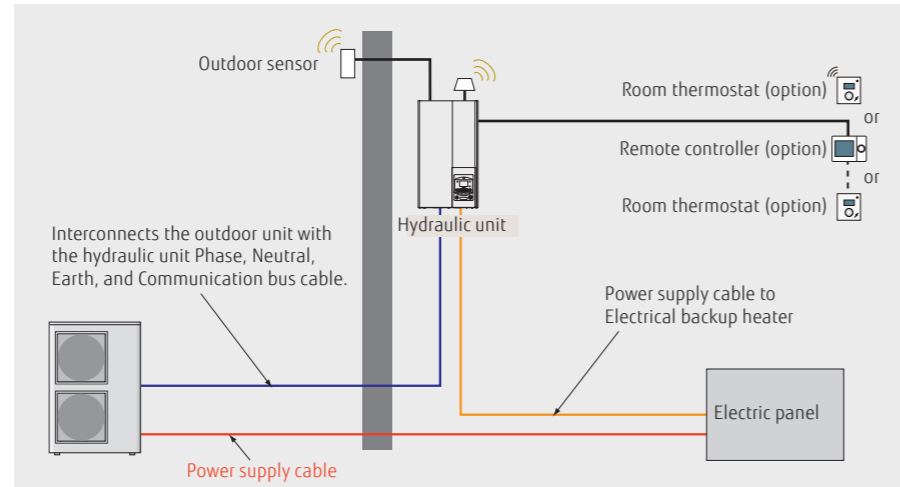
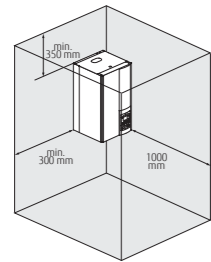

Split DHW Integrated Type Hydraulic Unit

- Floor standing
- Weight ≤ 393 kg (including water)
- Space for maintenance needs to be taken into consideration.

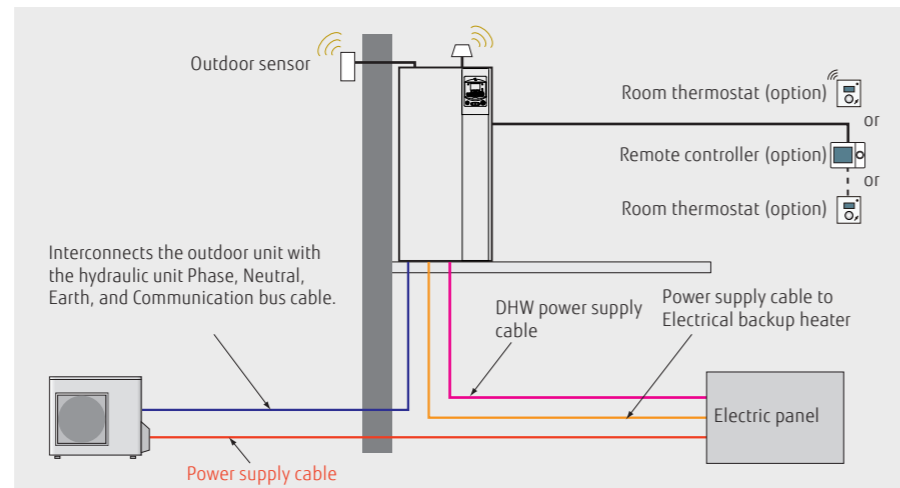
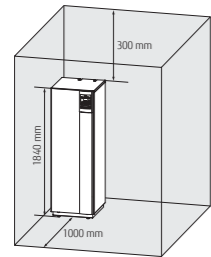

Piping and Wiring split type

Series	Capacity range (kW)	Pipe diameter (Liquid/Gas) (mm)	H1 (m)	H2 (m)	L (m)
R32 Comfort	5	6.35/12.70	+20	-20	3-30
	6				
	8				
High Power	10	9.52/15.88	+15	-15	5-20
	11				
	14				
Super High Power	15	9.52/15.88	+15	-25	5-30
	16				
	17				

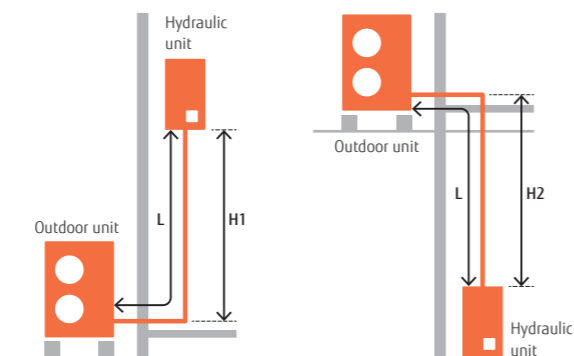

System Configuration

Split Type

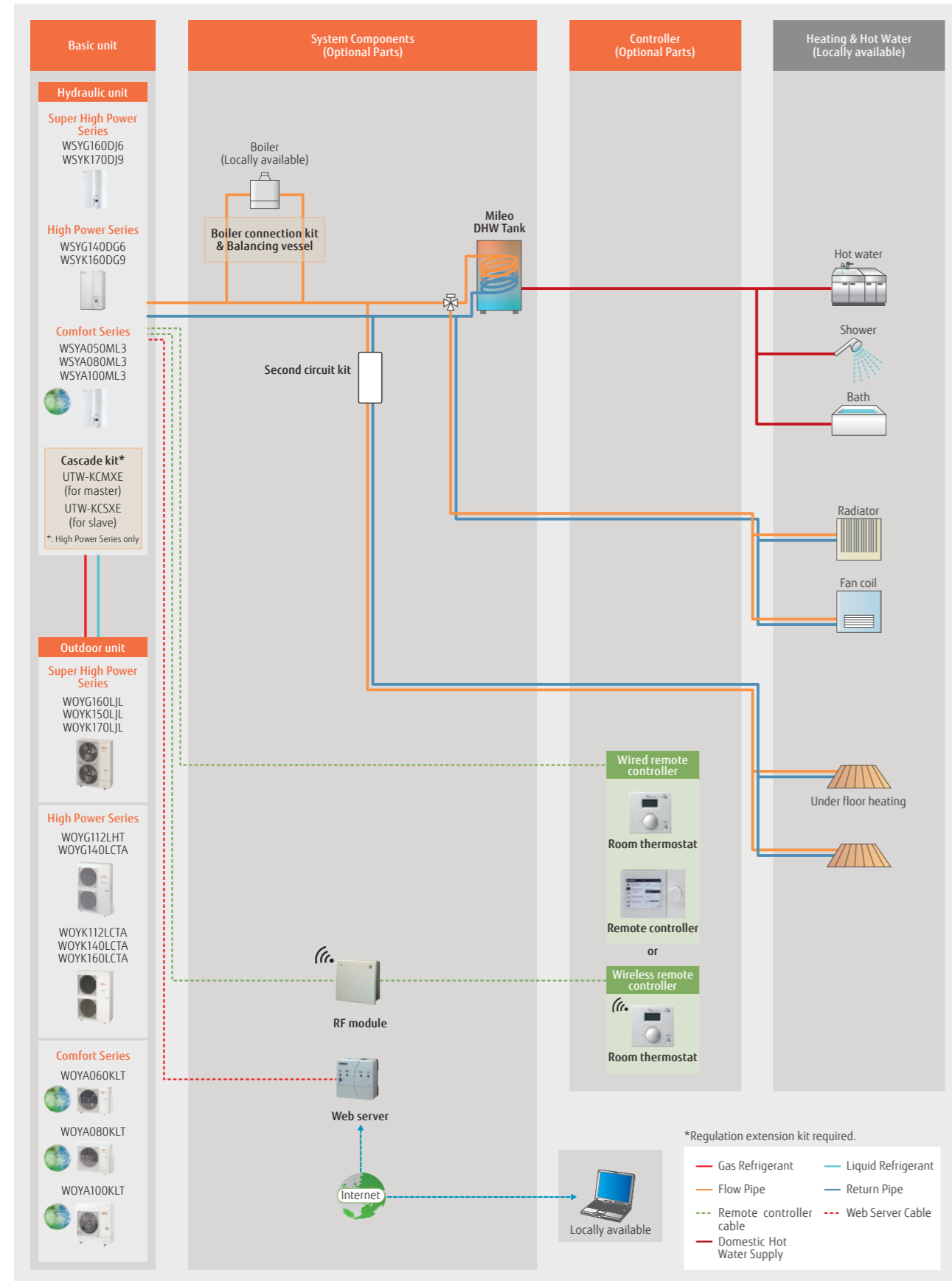

Split DHW Integrated Type

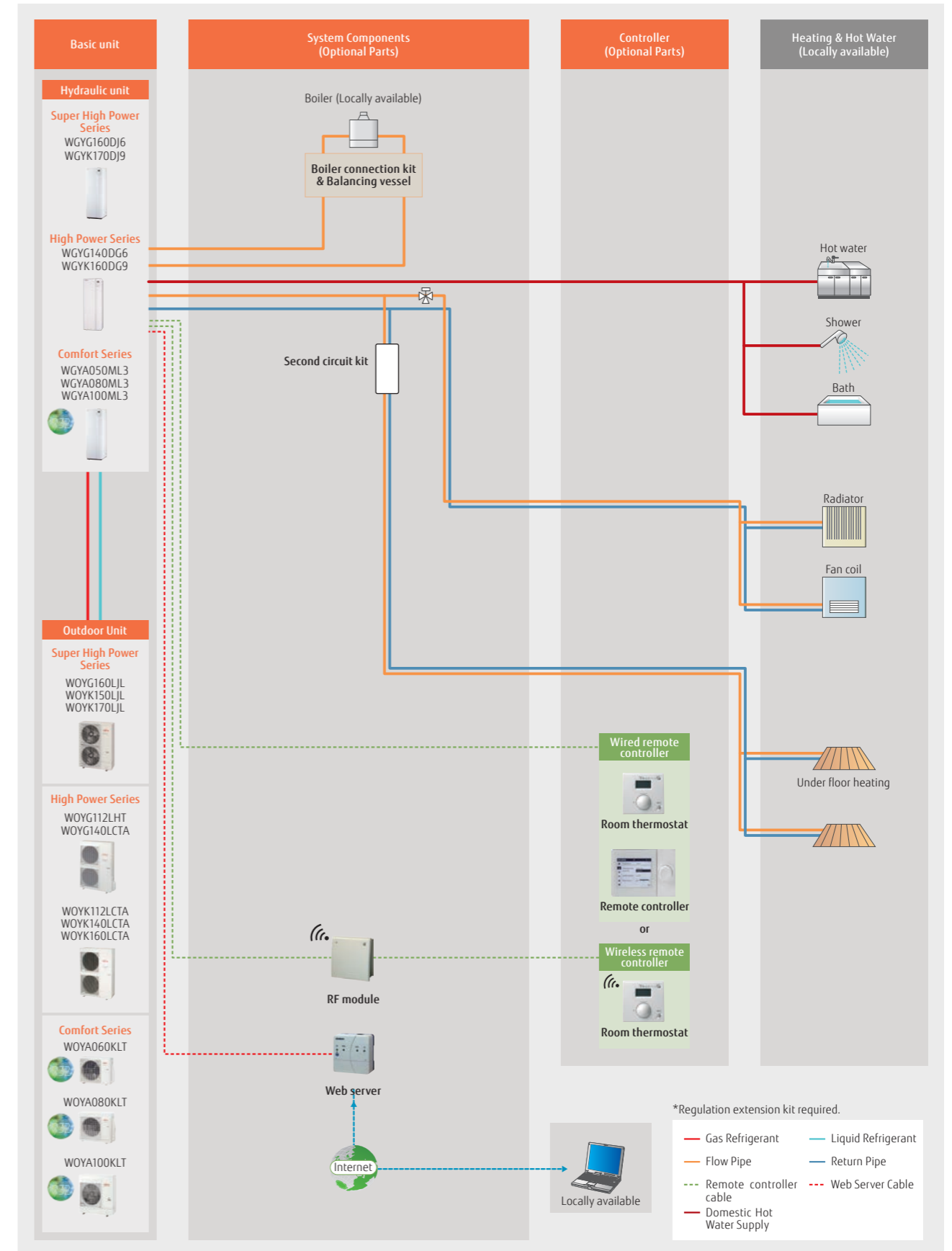

Case Studies

Split Type

2-emitter simultaneous heating (Individual control)
Underfloor heating + Radiator

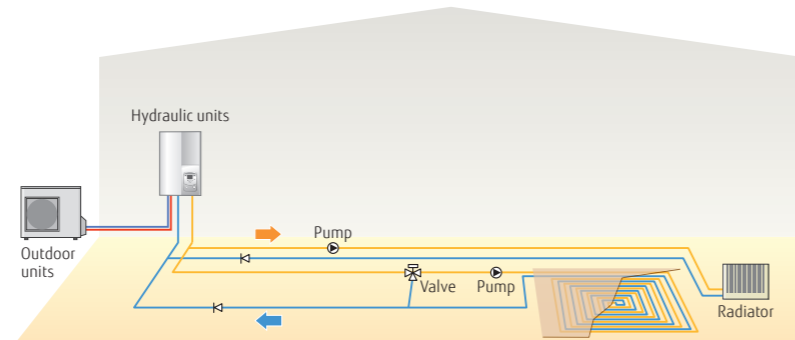

Boiler connected to heating (Boiler + Heating)

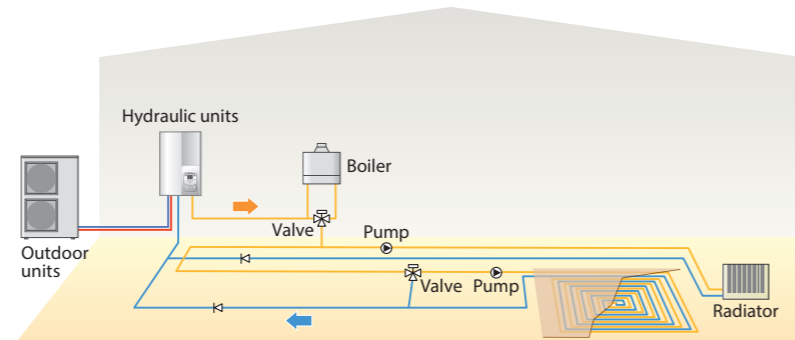

2-emitter simultaneous heating & domestic hot water supply (Cascade)

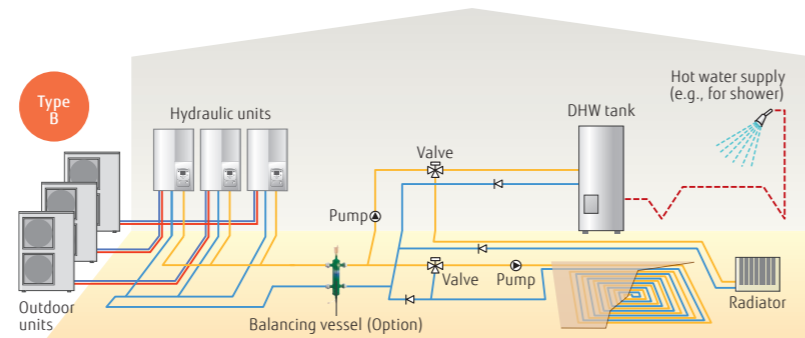
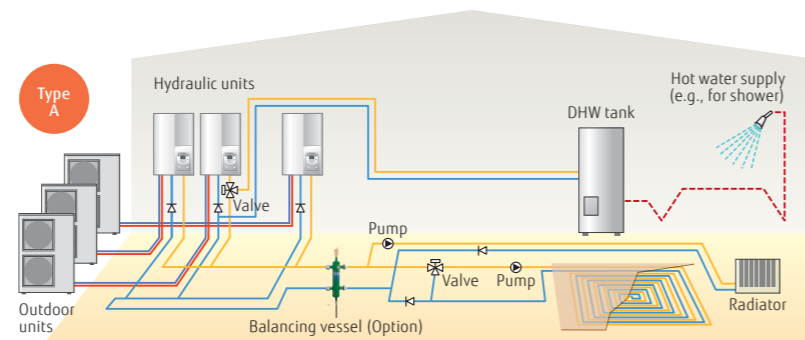

*The hydraulic layouts shown are mainly representation. Please check with local dealer for actual hydraulic connections.

Split DHW Integrated Type

Single heating & domestic hot water supply
Radiator + domestic hot water supply

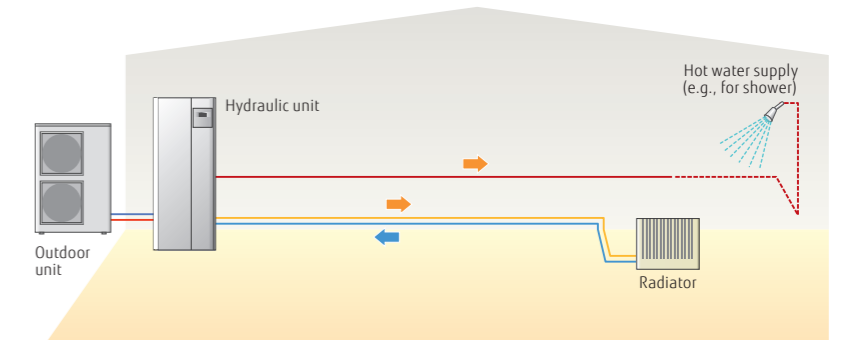

2-emitter simultaneous heating (Individual control) & domestic hot water supply
Radiator + domestic hot water supply

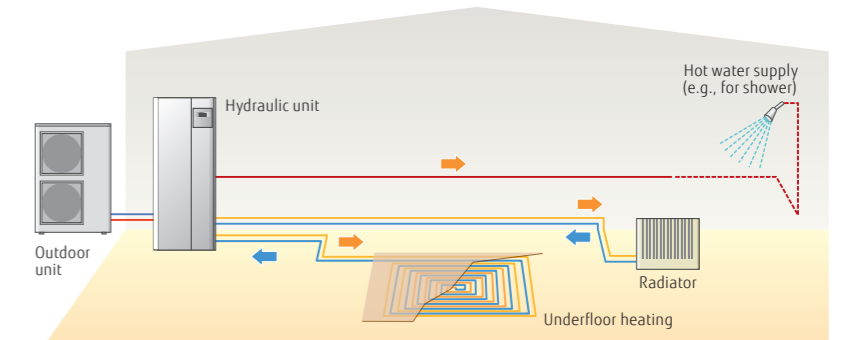

Boiler connected to heating (Boiler + Heating) and domestic hot water supply

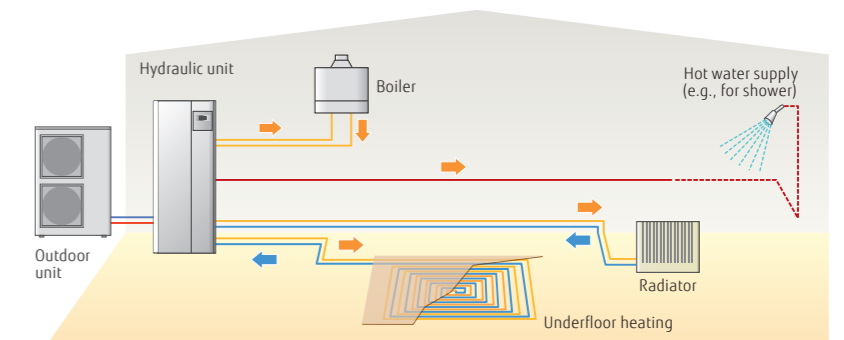

*The hydraulic layouts shown are mainly representation. Please check with local dealer for actual hydraulic connections.

Control Overview

To meet the diverse needs of customers, we offer a variety of control options, such as individual control and remote control options.

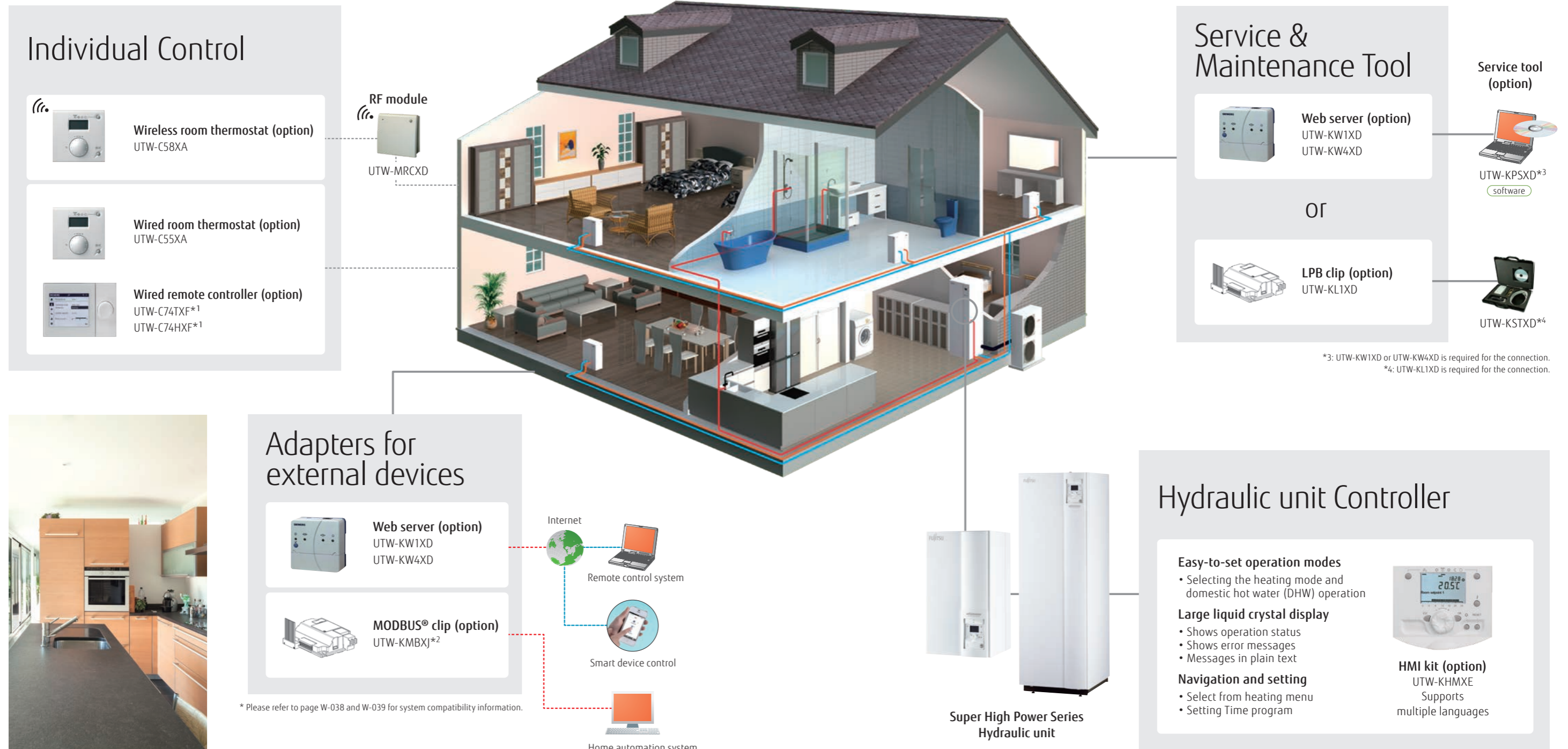

Optional Parts Overview

Various optional parts are available to use ATW according to needs and environments.



for Locally units



Second circuit Kit

It can supply hot water at different temperatures to each two types of heating equipment, such as radiators and underfloor heating.

UTW-KZSXE*¹



UTW-KZDXE*¹



UTW-KZSXJ



UTW-KZDXJ

Boiler connection kit

It can build hybrid systems using both boilers and heat pumps. Boiler and heat pumps are switched according to outside air temperature.



UTW-KBSXD



UTW-KBDXD



UTW-KBSXJ

*1: The UTW-KREXD (Regulation extension kit) is not included but is required for connection.



for Hydraulic unit



Circulating pump

UTW-PHFYG

The high-output pump for replacement of the standard pump in the hydraulic unit. It can be used in properties with longer and more complex water piping.

Cascade master/slave kit

Up to 3 hydraulic units can be connected for large-capacity use. It is need to install a primary kit in one unit and a secondary kit in one or two other units.



Cascade master kit (incl. LPB clip)



Cascade slave kit (incl. LPB clip)

Cooling kit

Required when using ATW also for cooling operation. It is used to prevent condensation occurring in the indoor unit.



UTW-KCLXD

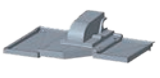

UTW-KCLXL

Electrical backup heater relay



UTW-KBHL

It allows the backup heater for heating at 3 kW as standard can be used at 6 kW.

for DHW



DHW kit

UTW-KDWXD (External)

Required to connect locally purchased DHW tanks to air to water.



DHW tank

200 Liters: UTW-T20AXH / UTW-T20BXH

300 Liters: UTW-T30AXH / UTW-T30BXH

The BXH series is a more efficient tank than the AXH series.

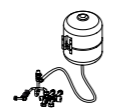

UTW-KDEXE



UTW-KDEXL

DHW expansion kit

The expansion vessel(18L) for connection to DHW water piping.

for Outdoor unit



Drain pan

UTW-KDPXB

It is used to collect and drain condensation water generated by outdoor units.



External connect kit

UTY-XWZXZ2 / UTY-XWZXZ3

The signal input (low noise mode, peak cut) and signal output (compressor operation, base pan heater control) for outdoor units are possible externally.



