

# FUJITSU

# INVERTER

AIR CONDITIONER

## MANUAL DE OPERAÇÃO

Tipo teto

## MANUAL DE FUNCIONAMIENTO

Tipo techo

## OPERATING MANUAL

Ceiling type

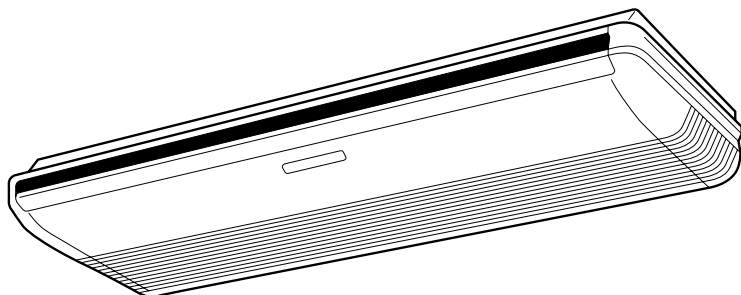

Português

Español

English

A garantia contratual somente é válida para produtos instalados por assistência técnica credenciada.

Guarde este manual para futura referência.  
Conserve este manual para futura referencia.  
Keep this manual for future reference.

FUJITSU GENERAL LIMITED



N.º DE PEÇA 9374379330-05

# CONTENTS

SAFETY PRECAUTIONS.....	1	ADJUSTING THE DIRECTION OF AIR CIRCULATION .....	9
FEATURES AND FUNCTIONS .....	2	SWING OPERATION .....	10
NAME OF PARTS .....	2	ECONOMY OPERATION .....	10
PREPARATION .....	4	CLEANING AND CARE.....	11
OPERATION.....	5	SELECTING THE REMOTE CONTROL UNIT	
TIMER OPERATION .....	7	SIGNAL CODE .....	12
SLEEP TIMER OPERATION.....	8	TROUBLESHOOTING .....	12
FILTER LAMP RESET.....	8	OPERATING TIPS.....	14
MANUAL AUTO OPERATION .....	8		

## SAFETY PRECAUTIONS

- Before using the appliance, read these “PRECAUTIONS” thoroughly and operate in the correct way.
- The instructions in this section all relate to safety; be sure to maintain safe operating conditions.
- “WARNING” and “CAUTION” have the following meanings in these instructions:

 <b>WARNING</b>	This mark indicates procedures which, if improperly performed, might lead to the death or serious injury of the user.
 <b>CAUTION</b>	This mark indicates procedures which, if improperly performed, might possibly result in personal harm to the user, or damage to property.

### **WARNING**

- Do not attempt to install this air conditioner by yourself.
- This unit contains no user-serviceable parts. Always consult authorized service personnel for repairs.
- When moving, consult authorized service personnel for disconnection and installation of the unit.
- Do not become over-exposed to cold air by staying in the direct path of the airflow of the air conditioner for extended periods of time.
- Do not insert fingers or objects into the outlet port or intake grilles.
- Do not start and stop air conditioner operation by turning off the electrical breaker and so on.
- Take care not to damage the power supply cable. If the supply cord is damaged, it must be replaced by the manufacturer, its service agent or similarly qualified persons in order to avoid a hazard.
- In the event of a malfunction (burning smell, etc.), immediately stop operation, turn off the electrical breaker, and consult authorized service personnel.

### **CAUTION**

- Provide occasional ventilation during use.
- Do not direct air flow at fireplaces or heating apparatus.
- Do not climb on, or place objects on, the air conditioner.
- Do not hang objects from the indoor unit.
- Do not set flower vases or water containers on top of air conditioners.
- Do not expose the air conditioner directly to water.
- Do not operate the air conditioner with wet hands.
- Turn off power source when not using the unit for extended periods.
- Always turn off the electrical breaker whenever cleaning the air conditioner or changing the air filter.
- Connection valves become hot during Heating; handle with care.
- Check the condition of the installation stand for damage.
- Do not place animals or plants in the direct path of the air flow.
- When restarting after a long period of disuse in the winter, turn the power switch on at least 12 hours before starting the unit.
- Do not drink the water drained from the air conditioner.
- Do not use in applications involving the storage of foods, plants or animals, precision equipment, or art works.
- Do not apply any heavy pressure to radiator fins.
- Operate only with air filters installed.
- Do not block or cover the intake grille and outlet port.
- Ensure that any electronic equipment is at least one metre away from either the indoor or outdoor units.
- Avoid installing the air conditioner near a fireplace or other heating apparatus.
- When installing the indoor and outdoor units, take precautions to prevent access by infants.
- Do not use inflammable gases near the air conditioner.
- This appliance is not intended for use by persons (including children) with reduced physical, sensory or mental capabilities, or lack of experience and knowledge, unless they have been given supervision or instruction concerning use of the appliance by a person responsible for their safety. Children should be supervised to ensure that they do not play with the appliance.

# FEATURES AND FUNCTIONS

## AUTOMATIC OPERATION

### ● COOLING MODEL

Merely press the START/STOP button, and the unit will begin automatic operation in the Cooling or Dry mode as appropriate, in accordance with the thermostat setting and the actual temperature of the room.

### ● HEAT & COOL MODEL (REVERSE CYCLE)

Merely press the START/STOP button, and the unit will begin automatic operation in either the Heating, Cooling or Monitor modes as appropriate, in accordance with the thermostat setting and the actual temperature of the room.

## SLEEP TIMER

### ● COOLING MODEL

When the SLEEP timer button is pressed during Cooling or Dry mode, the thermostat setting is gradually raised during the period of operation. When the set time is reached, the unit automatically turns off.

### ● HEAT & COOL MODEL (REVERSE CYCLE)

When the SLEEP timer button is pressed during Heating mode, the air conditioner's thermostat setting is gradually lowered during the period of operation; during Cooling or Dry mode, the thermostat setting is gradually raised during the period of operation. When the set time is reached, the unit automatically turns off.

## WIRELESS REMOTE CONTROL UNIT

The WIRELESS REMOTE CONTROL UNIT allows convenient control of air conditioner operation.

## OMNI-DIRECTIONAL AIR FLOW (SWING OPERATION)

Three-dimensional control over air direction swing is possible through dual use of both an UP/DOWN air direction swing and RIGHT/LEFT air direction swing. Since UP/DOWN air direction flaps operate automatically according to the operating mode of the unit, it is possible to set air direction based on the operating mode.

## MILDEW-RESISTANT FILTER

The AIR FILTER has been treated to resist mildew growth, thus allowing cleaner use and easier care.

# NAME OF PARTS

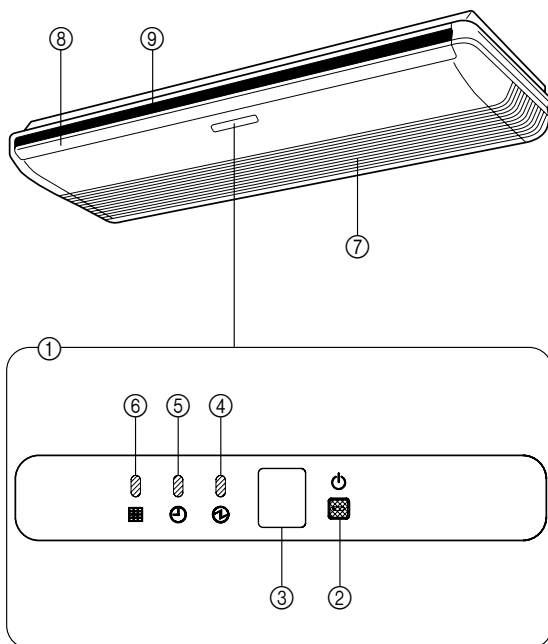

### Indoor Unit

- ① Operating Control Panel
- ② MANUAL AUTO button
- ③ Remote Control Signal Receiver
- ④ OPERATION Indicator Lamp
- ⑤ TIMER Indicator Lamp
- ⑥ FILTER Lamp
  - If the TIMER indicator lamp flashes when the timer is operating, it indicates that a fault has occurred with the timer setting (see page 14 AUTO Restart).
- ⑦ Intake Grille
- ⑧ UP/DOWN Air Direction Flaps
- ⑨ RIGHT/LEFT Air Direction Louvers (behind UP/DOWN Air Direction Flaps)

# NAME OF PARTS

## Remote controller

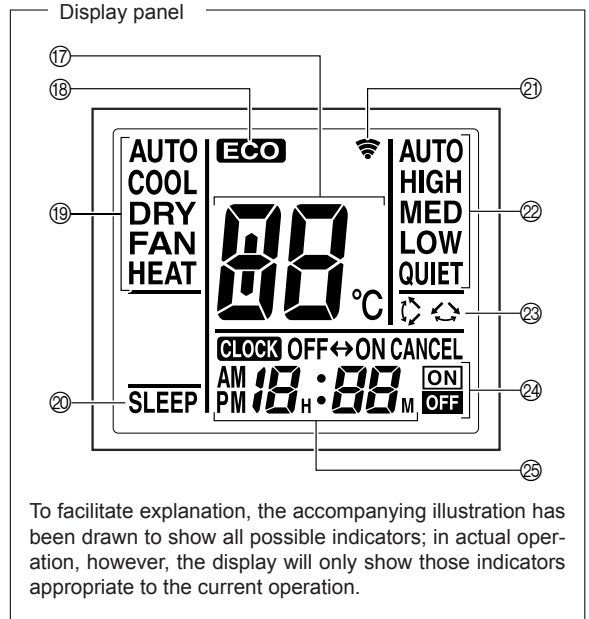
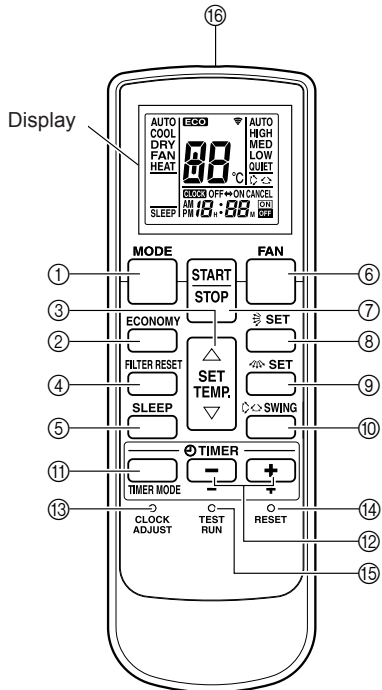

To facilitate explanation, the accompanying illustration has been drawn to show all possible indicators; in actual operation, however, the display will only show those indicators appropriate to the current operation.

- ① **MODE button**
- ② **ECONOMY button**
- ③ **SET TEMP. button (▲ / ▼)**
- ④ **FILTER RESET button**
- ⑤ **SLEEP button**
- ⑥ **FAN button**
- ⑦ **START/STOP button**
- ⑧ **SET button (Vertical)**
- ⑨ **SET button (Horizontal)**
- ⑩ **SWING button**
- ⑪ **TIMER MODE button**
- ⑫ **TIMER SET ( + / - ) button**
- ⑬ **CLOCK ADJUST button**
- ⑭ **RESET button**
- ⑮ **TEST RUN button**

- This button is used when installing the conditioner, and should not be used under normal conditions, as it will cause the air conditioner's thermostat function to operate incorrectly.
- If this button is pressed during normal operation, the unit will switch to test operation mode, and the Indoor Unit's OPERATION Indicator Lamp and TIMER Indicator Lamp will begin to flash simultaneously.
- To stop the test operation mode, press the START/STOP button to stop the air conditioner.

- ⑯ **Signal Transmitter**
- ⑰ **Temperature SET Display**
- ⑱ **ECONOMY Display**
- ⑲ **Operating Mode Display**
- ⑳ **SLEEP Display**
- ㉑ **Transmit Indicator**
- ㉒ **Fan Speed Display**
- ㉓ **SWING Display**
- ㉔ **Timer Mode Display**
- ㉕ **Clock Display**

# PREPARATION

## Load Batteries (Size AAA R03/LR03 × 2) \*

### 1 Press and slide the battery compartment lid on the reverse side to open it.

Slide in the direction of the arrow while pressing the ▼ mark.

\* Batteries are not included with this product.

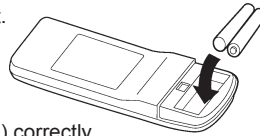

### 2 Insert batteries.

Be sure to align the battery polarities (⊕/⊖) correctly.

### 3 Close the battery compartment lid.

## ⚠ CAUTION

- Take care to prevent infants from accidentally swallowing batteries.
- When not using the Remote Control Unit for an extended period, remove the batteries to avoid possible leakage and damage to the unit.
- If leaking battery fluid comes in contact with your skin, eyes, or mouth, immediately wash with copious amounts of water, and consult your physician.
- Dead batteries should be removed immediately and disposed of properly, either in a battery collection receptacle or to the appropriate authority.
- Do not attempt to recharge dry batteries.

Never mix new and used batteries, or batteries of different types.

Batteries should last about one year under normal use. If the Remote Control Unit's operating range becomes appreciably reduced, replace the batteries and press the RESET button with the tip of a ballpoint pen or other small object.

## Set the Current time

### 1 Press the CLOCK ADJUST button.

Use the tip of a ball-point pen or other small object to press the button.

### 2 Use the TIMER SET ( ⊕ / ⊖ ) buttons to adjust the clock to the current time.

⊕ button: Press to advance the time.

⊖ button: Press to reverse the time.

(Each time the buttons are pressed, the time will be advanced/reversed in one-minute increments; hold the buttons depressed to change the time quickly in ten-minute increments.)

### 3 Press the CLOCK ADJUST button again.

This completes the time setting and starts the clock.

## To Use the Remote Control Unit

- The Remote Control Unit must be pointed at signal receiver to operate correctly.
- Operating Range: About 7 meters.
- When a signal is properly received by the air conditioner, a beeping sound will be heard.
- If no beep is heard, press the Remote Control Unit button again.

## Remote Control Unit Holder

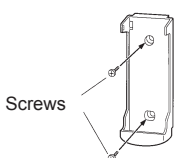

① Mount the Holder.

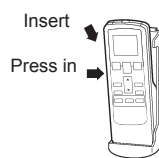

② Set the Remote Control Unit.

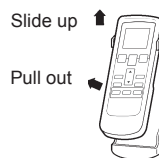

③ To remove the Remote Control Unit (when use at hand).

# OPERATION

## To Select Mode Operation

- 1 Press the START/STOP button.**  
The indoor unit's OPERATION Indicator Lamp will light.  
The air conditioner will start operating.
- 2 Press the MODE button to select the desired mode.**  
Each time the button is pressed, the mode will change in the following order.



About three seconds later, the entire display will reappear.

## To Set the Room temperature

**Press the SET TEMP. button.**

- ▲ button: Press to raise the thermostat setting.
- ▼ button: Press to lower the thermostat setting.

### ● Thermostat setting range:

AUTO .....	18-30 °C
Heating.....	16-30 °C
Cooling/Dry .....	18-30 °C

The thermostat cannot be used to set room temperature during the FAN mode (the temperature will not appear on the Remote Control Unit's Display).

About three seconds later, the entire display will reappear.

The thermostat setting should be considered a standard value, and may differ somewhat from the actual room temperature.

## To Set the Fan Speed

**Press the FAN button.**

Each time the button is pressed, the fan speed changes in the following order:



About three seconds later, the entire display will reappear.

### When set to AUTO:

- Heating:** Fan operates so as to optimally circulate warmed air.  
However, the fan will operate at very low speed when the temperature of the air issued from the indoor unit is low.
- Cooling:** As the room temperature approaches that of the thermostat setting, the fan speed becomes slower.
- Fan:** The fan runs at the low fan speed.

The fan will operate at a very low setting during Monitor operation and at the start of the Heating mode.

## QUIET Operation

### When set to Quiet:

- QUIET operation begins. The indoor unit's airflow will be reduced for quieter operation.
- QUIET operation cannot be used during Dry mode. (The same is true when dry mode is selected during AUTO mode operation.)
  - During Quiet operation, Heating and Cooling performance will be reduced somewhat. If the room does not warm up/cool down when using QUIET Operation, please adjust the air conditioner's Fan Speed.

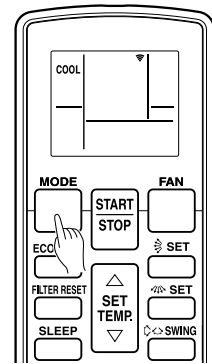

Example: When set to COOL.

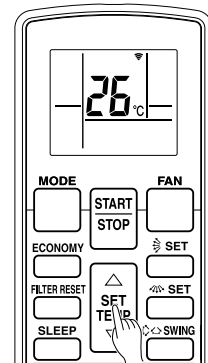

Example: When set to 26 °C.

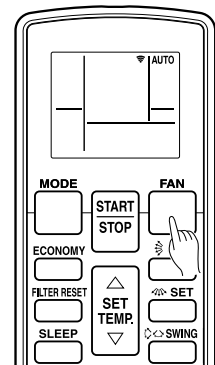

Example: When set to AUTO.

## To Stop Operation

### Press the START/STOP button.

The OPERATION Indicator Lamp will go out.

## About AUTO CHANGEOVER Operation

**AUTO:** ● When AUTO CHANGEOVER operation first selected, the fan will operate at very low speed for about one minute, during which time the unit detects the room conditions and selects the proper operating mode.

If the difference between thermostat setting and actual room temperature is more than +2 °C

→ Cooling or dry operation

(Monitor operation may be selected if the outdoor temperature is low.)

If the difference between thermostat setting and actual room temperature is within ±2 °C

→ Monitor operation

If the difference between thermostat setting and actual room temperature is more than -2 °C

→ Heating operation

(Monitor operation may be selected if the outdoor temperature is high.)

● When the air conditioner has adjusted your room's temperature to near the thermostat setting, it will begin monitor operation. In the monitor operation mode, the fan will operate at low speed. If the room temperature subsequently changes, the air conditioner will once again select the appropriate operation (Heating, Cooling) to adjust the temperature to the value set in the thermostat.

(The monitor operation range is ±2 °C relative to the thermostat setting.)

● If the mode automatically selected by the unit is not what you wish, select one of the mode operation (HEAT, COOL, DRY, FAN).

## About Mode Operation

**Heating:** ● Use to warm your room.

● When Heating mode is selected, the air conditioner will operate at very low fan speed for about 3 to 5 minutes, after which it will switch to the selected fan setting. This period of time is provided to allow the indoor unit to warm up before beginning full operation.

● When the room temperature is very low, frost may form on the outside unit, and its performance may be reduced. In order to remove such frost, the unit will automatically enter the defrost cycle from time to time. During Automatic Defrosting operation, the OPERATION Indicator Lamp will flash, and the heat operation will be interrupted.

● After the start of heating operation, it takes some time before the room gets warmer.

**Cooling:** ● Use to cool your room.

**Dry:** ● Use for gently cooling while dehumidifying your room.

● You cannot heat the room during Dry mode.

● During Dry mode, the unit will operate at low speed; in order to adjust room humidity, the indoor unit's fan may stop from time to time. Also, the fan may operate at very low speed when adjusting room humidity.

● The fan speed cannot be changed manually when Dry mode has been selected.

**Fan:** ● Use to circulate the air throughout your room.

### During Heating mode:

Set the thermostat to a temperature setting that is higher than the current room temperature. The Heating mode will not operate if the thermostat is set lower than the actual room temperature.

### During Cooling/Dry mode:

Set the thermostat to a temperature setting that is lower than the current room temperature. The Cooling and Dry modes will not operate if the thermostat is set higher than the actual room temperature (in Cooling mode, the fan alone will operate).

### During Fan mode:

You can not use the unit to heat and cool your room.

# TIMER OPERATION

Before using the timer function, be sure that the Remote Control Unit is set to the correct current time (see P. 4).  
If the indoor unit is connected to a wired remote controller, the wireless remote controller cannot be used to set the timer.

## To Use the ON timer or OFF timer

### 1 Press the START/STOP button (if the unit is already operating, proceed to step 2).

The indoor unit's OPERATION Indicator Lamp will light.

### 2 Press the TIMER MODE button to select the OFF timer or ON timer operation.

Each time the button is pressed the timer function changes in the following order:

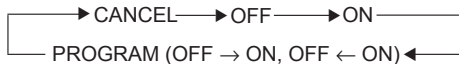

The indoor unit's green TIMER Indicator Lamp (orange) will light.

### 3 Use the TIMER SET buttons to adjust the desired OFF time or ON time.

Set the time while the time display is flashing (the flashing will continue for about five seconds).

**[+]** button: Press to advance the time.

**[-]** button: Press to reverse the time.

About five seconds later, the entire display will reappear.

#### To Cancel the Timer

Use the TIMER MODE button to select "CANCEL".

The air conditioner will return to normal operation.

#### To Change the Timer Settings

Perform steps 2 and 3.

#### To Stop Air Conditioner Operation while the Timer is Operating

Press the START/STOP button.

#### To Change Operating Conditions

If you wish to change operating conditions (Mode, Fan Speed, Thermostat Setting, QUIET mode), after making the timer setting wait until the entire display reappears, then press the appropriate buttons to change the operating condition desired.

## To Use the Program timer

### 1 Press the START/STOP button (if the unit is already operating, proceed to step 2).

The indoor unit's OPERATION Indicator Lamp will light.

### 2 Set the desired times for OFF timer and ON timer.

See the section "To Use the ON timer or OFF timer" to set the desired mode and times.

About three seconds later, the entire display will reappear.

The indoor unit's TIMER Indicator Lamp will light.

### 3 Press the TIMER MODE button to select the PROGRAM timer operation (OFF → ON or OFF ← ON will display).

The display will alternately show "OFF timer" and "ON timer", then change to show the time setting for the operation to occur first.

- The program timer will begin operation. (If the ON timer has been selected to operate first, the unit will stop operating at this point.)

About five seconds later, the entire display will reappear.

#### To Cancel the Timer

Use the TIMER MODE button to select "CANCEL".

The air conditioner will return to normal operation.

#### To Change the Timer Settings

1. Follow the instructions given in the section "To Use the ON Timer or OFF Timer" to select the timer setting you wish to change.
2. Press the TIMER MODE button to select either OFF → ON or OFF ← ON.

#### To Stop Air Conditioner Operation while the Timer is Operating

Press the START/STOP button.

#### To Change Operating Conditions

If you wish to change operating conditions (Mode, Fan Speed, Thermostat Setting, QUIET mode), after making the timer setting wait until the entire display reappears, then press the appropriate buttons to change the operating condition desired.

## About the Program timer

- The program timer allows you to integrate OFF timer and ON timer operations in a single sequence. The sequence can involve one transition from OFF timer to ON timer, or from ON timer to OFF timer, within a twenty-four hour period.
- The first timer function to operate will be the one set nearest to the current time. The order of operation is indicated by the arrow in the Remote Control Unit's Display (OFF → ON, or OFF ← ON).
- One example of Program timer use might be to have the air conditioner automatically stop (OFF timer) after you go to sleep, then start (ON timer) automatically in the morning before you arise.



# SLEEP TIMER OPERATION

Unlike other timer functions, the SLEEP timer is used to set the length of time until air conditioner operate is stopped. If the indoor unit is connected to a wired remote controller, the wireless remote controller cannot be used to set the sleep timer.

## To Use the SLEEP Timer

While the air conditioner is operating or stopped, press the **SLEEP** button.

The indoor unit's OPERATION Indicator Lamp lights and the TIMER Indicator Lamp light.

## To Change the Timer Settings

Press the **SLEEP** button once again and set the time using the **TIMER SET** ( **+** / **-** ) buttons.

**+** button: Press to advance the time.

**-** button: Press to reverse the time.

About five seconds later, the entire display will reappear.

## About the SLEEP Timer

To prevent excessive warming or cooling during sleep, the SLEEP timer function automatically modifies the thermostat setting in accordance with the set time setting. When the set time has elapsed, the air conditioner completely stops.

### During Heating operation:

When the SLEEP timer is set, the thermostat setting is automatically lowered 1 °C every thirty minutes. When the thermostat has been lowered a total of 4 °C, the thermostat setting at that time is maintained until the set time has elapsed, at which time the air conditioner automatically turns off.

SLEEP timer setting

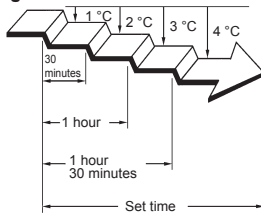

### During Cooling/Dry operation:

When the SLEEP timer is set, the thermostat setting is automatically raised 1 °C every 1 hour. When the thermostat has been raised a total of 2 °C, the thermostat setting at that time is maintained until the set time has elapsed, at which time the air conditioner automatically turns off.

SLEEP timer setting

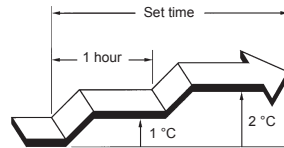

# FILTER LAMP RESET

Some indoor unit models are equipped with a filter lamp in the indoor unit display to indicate when it is time to clean the air filters.

## To Reset Filter Lamp

Press the **FILTER RESET** button.  
The indoor unit's **FILTER LAMP** will go out.

# MANUAL AUTO OPERATION

Use the **MANUAL AUTO** operation in the event the remote control unit is lost or otherwise unavailable.

## How To Use the Main Unit Controls

Press the **MANUAL AUTO** button on the main unit control panel.

To stop operation, press the **MANUAL AUTO** button once again.

- When the air conditioner is operated with the controls on the Main unit, it will operate under the same mode as the **AUTO** mode selected on the remote control unit.
- The fan speed selected will be "AUTO" and the thermostat setting will be 24 °C.

# ADJUSTING THE DIRECTION OF AIR CIRCULATION

Instructions relating to heating (\*) are applicable only to "HEAT & COOL MODEL" (Reverse Cycle).

- Adjust the up, down, left and right AIR directions with the AIR DIRECTION buttons on the Remote Control Unit.
- Use the AIR DIRECTION buttons after the Indoor Unit has started operating and the airflow-direction louvers have stopped moving.

## Vertical Air Direction Adjustment

### Press the SET button (Vertical).

Each time the button is pressed, the air direction range will change as follows:



#### Types of Air flow Direction Setting:

- ①, ②, ③ : During Cooling/Dry Modes
- ①, ②, ③, ④, ⑤ : \* During Heating mode

The remote control unit's display does not change.

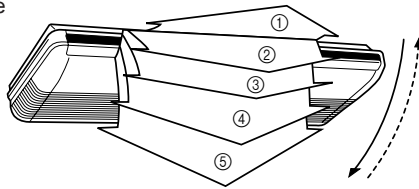

- Use the air direction adjustments within the ranges shown above.
- The vertical airflow direction is set automatically as shown, in accordance with the type of operation selected.
  - Horizontal flow ① : During Cooling/Dry mode
  - Downward flow ⑤ : \*During Heating mode
- During AUTO mode operation, for the first minute after beginning operation, airflow will be horizontal ①; the air direction cannot be adjusted during this period.

### ⚠ WARNING

Never place fingers or foreign objects inside the outlet ports, since the internal fan operates at high speed and could cause personal injury.

- Attempting to move UP/DOWN air direction flaps or RIGHT/LEFT air direction louvers manually could result in improper operation; in this case, stop operation and restart. The louvers should begin to operate properly again.
- During use of the Cooling and Dry modes, do not set the UP/DOWN air direction flaps in the Heating range (④ to ⑤) for long periods of time, since water vapor may condense near the outlet louvers and drops of water may drip from the air conditioner. During the Cooling and Dry modes, if the Air Flow Direction Louvers are left in the heating range for more than 30 minutes, they will automatically return to position ③.
- When used in a room with infants, children, elderly or sick persons, the air direction and room temperature should be considered carefully when making settings.

## Horizontal Air Direction Adjustment

### Press the SET button (Horizontal).

Each time the button is pressed, the air direction range will change as follows:



The remote control unit's display does not change.

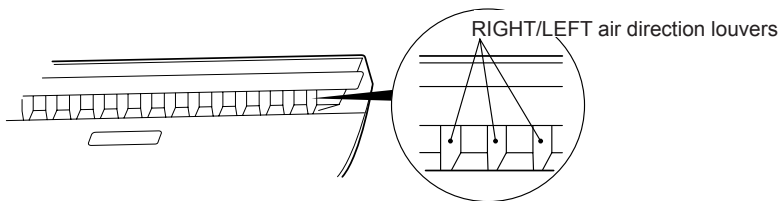

- Use the air direction adjustments within the ranges shown as follows.

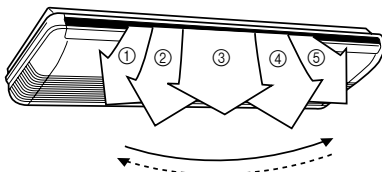

# SWING OPERATION

Begin air conditioner operation before performing this procedure.

## To select SWING Operation

### Press the SWING button.

Each time the SWING button is pressed, the swing operation will change in the following order.

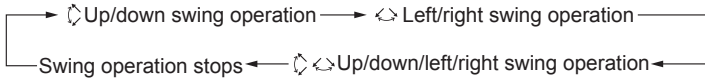

## To stop SWING Operation

### Press the SWING button and select STOP.

Airflow direction will return to the setting before swing was begun.

## About Swing Operation

### To select Up/down swing operation

The type of operation	Range of swing
Cooling/Dry	① to ④
Heating	③ to ⑤
Fan	① to ⑤

- The SWING operation may stop temporarily when the air conditioner's fan is not operating, or when operating at very low speeds.

### To select Left/right swing operation

The type of operation	Range of swing
Cooling/Dry	① to ⑤ (All range)
Heating	① to ⑤ (All range)
Fan	① to ⑤ (All range)

- The SWING operation may stop temporarily when the air conditioner's fan is not operating, or when operating at very low speeds.

# ECONOMY OPERATION

Begin Air Conditioner operation before performing this procedure.

## To Use the ECONOMY Operation

### Press the ECONOMY button.

"ECO" appears on the Remote Control Unit display. Economy operation begins.

## To Stop the ECONOMY Operation

### Press the ECONOMY button again.

"ECO" disappears from the Remote Control Unit display. Normal operation begins.

## About ECONOMY Operation

At the maximum output, ECONOMY Operation is approximately 70% of normal air conditioner operation for cooling and heating. When ECONOMY operation is performed during the cooling mode, dehumidification is improved. This function is especially convenient when you want to remove the humidity in the room without significantly lowering the room temperature. During ECONOMY operation, the thermostat setting automatically changes according to the temperature to avoid Unnecessary cooling and heating for the most economical operation.

- If the room is not cooled (or heated) well during economy operation, select normal operation.
- Once air conditioner operation is stopped, normal operation begins when the indoor unit is turned on again.
- During the monitor period in the AUTO mode, the air conditioner operation will not change to ECONOMY operation even if ECONOMY operation is selected by pressing the ECONOMY operation button.

# CLEANING AND CARE



## CAUTION

- Before cleaning the air conditioner, be sure to turn it off and turn off the electrical breaker.

- To avoid excessive wear of the part and components or malfunctioning of the air conditioning, the user/consumer shall perform preventive maintenance through an accredited technical assistance, periodically. To know the preventive maintenance periodicity, the consumer shall check with the accredited installer or an accredited technical assistance.
- When used for extended periods, the unit may accumulate dirt inside, reducing its performance. We recommend that the unit be inspected regularly, in addition to your own cleaning and care. For more information, consult authorized service personnel.
- It is recommended for the user/consumer to demand a copy of the Work Order every time there is a visit of a technical assistance for verification, maintenance, test or repair of the product.
- When cleaning the unit's body, do not use water hotter than 40 °C, harsh abrasive cleansers, or volatile agents like benzene or thinner.
- Do not expose the unit body to liquid insecticides or hairsprays.
- If the unit will not be operated for a period of one month or more, be sure to allow the inner parts of the unit to dry thoroughly, in advance, by operating the unit in fan mode for half a day.

## Cleaning the Air Filter

When the FILTER Lamp is blinking, remove the filter and clean it.

### 1. Pull the air filters upward to remove them.

Remove the air filters by raising its handle while pulling it out towards you.

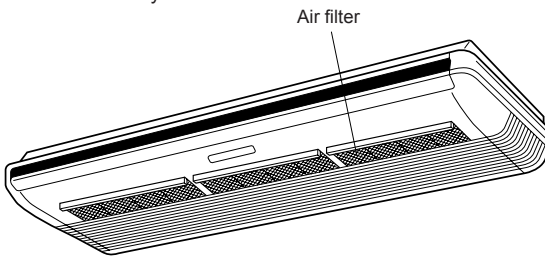

### 2. Clean the air filters.

Remove the dust from the air filters by vacuuming or washing them. After washing, allow the air filters to dry thoroughly in an area protected from sunlight.

### 3. Re-attach the air filters to the intake grille.

The air filters fit onto the inside of the intake grille.

- Dust can be cleaned from the air filter either with a vacuum cleaner, or by washing the filter in a solution of mild detergent and warm water. If you wash the filter, be sure to allow it to dry thoroughly in a shady place before reinstalling.
- If dirt is allowed to accumulate on the air filter, air flow will be reduced, lowering operating efficiency and increasing noise.
- After turning the power on, press the filter button on the remote control to turn off the filter lamp.

# SELECTING THE REMOTE CONTROL UNIT SIGNAL CODE

When two or more air conditioners are installed in a room and the remote control unit is operating an air conditioner other than the one you wish to set, change the signal code of the remote control unit to operate only the air conditioner you wish to set (four selections possible).

When two or more air conditioners are installed in a room, please contact your retailer to set the individual air conditioner signal codes.

## Selecting the Remote Control Unit Signal Code

Use the following steps to select the signal code of the remote control unit. (Note that the air conditioner cannot receive a signal code if the air conditioner has not been set for the signal code.)

- 1** Press the **START/STOP** button until only the clock is displayed on the remote control unit display.
- 2** Press the **MODE** button for at least five seconds to display the current signal code (initially set to **A**).
- 3** Press the **▲ / ▼** buttons to change the signal code between **A→b→c→d**. Match the code on the display to the air conditioner signal code.
- 4** Press the **MODE** button again to return to the clock display. The signal code will be changed.

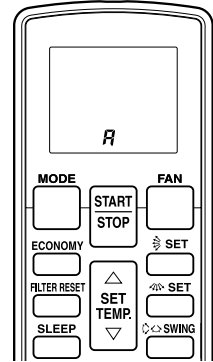

If no buttons are pressed within 30 seconds after the signal code is displayed, the system returns to the original clock display. In this case, start again from step 1.

The air conditioner signal code is set to A prior to shipment. Contact your retailer to change the signal code.

The remote control unit resets to signal code A when the batteries in the remote control unit are replaced. If you use a signal code other than signal code A, reset the signal code after replacing the batteries. If you do not know the air conditioner signal code setting, try each of the signal codes (**A→b→c→d**) until you find the code which operates the air conditioner.

## TROUBLESHOOTING

Instructions relating to heating (\*) are applicable only to “HEAT & COOL MODEL” (Reverse Cycle).



### WARNING

In the event of a malfunction (burning smell, etc.), immediately stop operation, disconnect the power supply plug or turn off the circuit breaker, and consult authorized service personnel.

Merely turning off the unit's power switch will not completely disconnect the unit from the power source. Always be sure to disconnect the power supply plug or turn off your circuit breaker to ensure that power is completely off.

Before requesting service, perform the following checks:

	Symptom	Problem	See page
NORMAL FUNCTION	Doesn't operate immediately:	<ul style="list-style-type: none"> <li>● If the unit is stopped and then immediately started again, the compressor will not operate for about 3 minutes, in order to prevent fuse blowouts.</li> <li>● Whenever the power supply plug is disconnected and then reconnected to a power outlet, the protection circuit will operate for about 3 minutes, preventing unit operation during that period.</li> </ul>	—
	Noise is heard:	<ul style="list-style-type: none"> <li>● During operation and immediately after stopping the unit, the sound of water flowing in the air conditioner's piping may be heard. Also, noise may be particularly noticeable for about 2 to 3 minutes after starting operation (sound of coolant flowing).</li> <li>● During operation, a slight squeaking sound may be heard. This is the result of minute expansion and contraction of the front cover due to temperature changes.</li> </ul>	—
		*● During Heating operation, a sizzling sound may be heard occasionally. This sound is produced by the Automatic Defrosting operation.	14

# TROUBLESHOOTING

Instructions relating to heating (\*) are applicable only to "HEAT & COOL MODEL" (Reverse Cycle).

	Symptom	Problem	See page
NORMAL FUNCTION	Smells:	● Some smell may be emitted from the indoor unit. This smell is the result of room smells (furniture, tobacco, etc.) which have been taken into the air conditioner.	—
	Mist or steam are emitted:	● During Cooling or Dry operation, a thin mist may be seen emitted from the indoor unit. This results from the sudden Cooling of room air by the air emitted from the air conditioner, resulting in condensation and misting.	—
		*● During Heating operation, the outdoor unit's fan may stop, and steam may be seen rising from the unit. This is due to the Automatic Defrosting operation.	14
	Airflow is weak or stops:	*● When Heating operation is started, fan speed is temporarily very low, to allow internal parts to warm up. *● During Heating operation, if the room temperature rises above the thermostat setting, the outdoor unit will stop, and the indoor unit will operate at very low fan speed. If you wish to warm the room further, set the thermostat to a higher setting.	—
		*● During Heating operation, the unit will temporarily stop operation (between 4 and 15 minutes) as the Automatic Defrosting mode operates. During the Automatic Defrosting operation, the OPERATION indicator lamp will flash.	14
		● The fan may operate at very low speed during Dry operation or when the unit is monitoring the room's temperature.	—
		● During QUIET operation, the fan will operate at very low speed. ● In the monitor AUTO operation, the fan will operate at very low speed.	—
	Water is produced from the outdoor unit:	*● During Heating operation, water may be produced from the outdoor unit due to the Automatic Defrosting operation.	14
The FILTER lamp blinks:	● Clean the filter. Afterwards, turn the FILTER lamp off.	8	
CHECK ONCE MORE	Doesn't operate at all:	● Has the circuit breaker been turned off? ● Has there been a power failure? ● Has a fuse blown out, or a circuit breaker been tripped?	—
		● Is the timer operating?	7 to 8
	Poor Cooling (or *Heating) performance:	● Is the air filter dirty? ● Are the air conditioner's intake grille or outlet port blocked? ● Did you adjust the room temperature settings (thermostat) correctly? ● Is there a window or door open? ● In the case of Cooling operation, is a window allowing bright sunlight to enter? (Close the curtains.) ● In the case of Cooling operation, are there heating apparatus and computers inside the room, or are there too many people in the room?	—
		● Is the unit set for QUIET operation?	—
The unit operates differently from the remote control unit's setting:	● Are the remote control unit's batteries dead? ● Are the remote control unit's batteries loaded properly?	4	
Signal is not received after replacing the batteries for the remote control unit:	● Are you using an air conditioner signal code other than signal code A?	12	

If the problem persists after performing these checks, or if you notice burning smells, or the TIMER indicator lamp and operation indicator lamp flashes, stop operation immediately, disconnect the power supply plug, and consult with authorized service personnel.

# OPERATING TIPS

Instructions relating to heating (\*) are applicable only to "HEAT & COOL MODEL" (Reverse Cycle).

## \*Heating Performance

- This air conditioner operates on the heat-pump principle, absorbing heat from outdoor air and transferring that heat indoors. As a result, the operating performance is reduced as outdoor air temperature drops. If you feel that insufficient heating performance is being produced, we recommend you use this air conditioner in conjunction with another kind of heating appliance.
- Heat-pump air conditioners heat your entire room by recirculating air throughout the room, with the result that some time may be required after first starting the air conditioner until the room is heated.

## \*When Indoor and Outdoor Temperature are High

- When both indoor and outdoor temperatures are high during use of the heating mode, the outdoor unit's fan may stop at times.

## \*Microcomputer-controlled Automatic Defrosting

- When using the Heating mode under conditions of low outdoor temperature and high humidity, frost may form on the outdoor unit, resulting in reduced operating performance.  
In order to prevent this kind of reduced performance, this unit is equipped with a Microcomputer-controlled Automatic Defrosting function. If frost forms, the air conditioner will temporarily stop, and the defrosting circuit will operate briefly (for about 4 to 15 minutes).  
During Automatic Defrosting operation, the OPERATION indicator lamp will flash.

## \*Low Ambient Cooling

- When the outdoor temperature drops, the outdoor unit's fans may switch to Low Speed.

## \*Hot start (for heating)

- The indoor unit prevents cold drafts when heating operation begins.  
The indoor unit fan will not operate or it will operate at a very low speed until the heat exchanger reaches the set temperature.

## AUTO Restart

### In Event of Power Interruption

- Should the power supply to the air conditioner be interrupted by a power failure, the air conditioner will restart automatically in the previously selected mode once the power is restored.
- Should a power failure occur during TIMER operation, the timer will be reset and the unit will begin (or stop) operating under the new timer setting. In this event, the TIMER indicator lamp will flash.
- Use of other electrical appliances (electric shaver, etc.) or nearby use of a wireless radio transmitter may cause the air conditioner to malfunction. In this event, temporarily disconnect the power supply plug, reconnect it, and then use the remote control unit to resume operation.

## Notice

Instructions relating to heating (\*) are applicable only to "HEAT & COOL MODEL" (Reverse Cycle).

- \*● During use of the heating mode, the outdoor unit will occasionally commence the defrost operation for brief periods. During the defrosting operation, if the user sets the indoor unit for heating again, the defrosting mode will continue, and the heating operation will begin after completion of defrosting, with the result that some time may be required before warm air is emitted.
- \*● During use of the heating mode, the top of the indoor unit may become warm, but this is due to the fact that coolant is circulated through the indoor unit even when it is stopped; it is not a malfunction.



**FUJITSU GENERAL LIMITED**  
1116, Suenaga, Takatsu-ku, Kawasaki 213-8502, Japan