

**Floor (9000 BTU) Indoor Unit
For Heat-recovery/Heat-pump Airstage VRF System**

Job Name _____
 Location _____
 Engineer _____
 Submitted To _____
 Submitted By _____
 Reference _____

Date _____
 Approval _____
 Construction _____
 Unit No _____
 Drawing No _____

FEATURES

- Floor mount models can fit easily under most windows and replace a radiator twice its size
- Quiet and powerful airflow
- Louver auto-swing in two directions
- Auto-closing louvers
- Very low power usage
- Compatible with 2-wire remotes only
- 10 year Extended Warranty on parts and compressor. See Warranty Statement.



PIPING ACCESSORIES

UTP-AX090A	Separation Tube - 2-Pipe - 90 MBH or Less
UTP-AX180A	Separation Tube - 2-Pipe - 91 to 180 MBH
UTP-AX567A	Separation Tube - 2-Pipe - 180 MBH or More

CONTROLLER

UTY-RNKU	Wired Remote Control
UTY-LNHU	Wireless Remote Controller (requires IR Receiver)
UTY-DCGY	Central Remote Controller (100 units)
UTY-DTGYZ1	Touch Panel Controller with Internet (400 units)

ACCESSORIES

#N/A	#N/A
UTY-XSZX	Remote Sensor for ducted units

WEIGHT AND DIMENSIONS

Enclosure - Net Weight - lbs [kg]	33 [15]
Enclosure - Gross Weight - lbs [kg]	42 [19]
Dimensions - Net (H x W x D) - in [mm]	23-5/8x29-1/8x7-7/8 600x740x200
Dimensions - Gross (H x W x D) - in [mm]	27-9/16x32-5/16x12-3/16 700x820x310

CAPACITY

Capacity - Cooling - Btu/h [kW]	9,500 [2.8]
Capacity - Heating - Btu/h [kW]	10,900 [3.2]

ELECTRICAL

Power Source	208 / 230V, 1-Phase, 60Hz
Available Voltage Range - VAC	187 to 253
Input Power - W	17
Full Load Amps - FLA - A	0.2
Max Circuit Breaker - A	15
Minimum Circuit Ampacity - MCA - A	0.25

FAN

Fan Type	Cross flow x 2
Airflow Rate - High - CFM [m³/h]	294 [500]
Airflow Rate - Medium - CFM [m³/h]	235 [400]
Airflow Rate - Low - CFM [m³/h]	194 [330]

SOUND PRESSURE

Sound Pressure Level - dB(A)	28/31/36
------------------------------	----------

WIRING

Communication Cable	LonWorks (Fujitsu Pink Cable. See AE Bulletin 009)
---------------------	--

PIPING

Connection Pipe Diameter - Liquid (Flare) - in [mm]	ø 1/4 [6.35]
Connection Pipe Diameter - Gas (Flare) - in [mm]	ø 3/8 [12.70]
Connection Pipe Diameter - Drain (ID; OD) - in [mm]	ø9/16 (13.8)
Drain-Pump	Optional

ETL

E.T.L.	91987
--------	-------

TEMPERATURE SETTINGS

Operating Temp. Cooling (DB) - °F [°C]	64 to 90 [18 to 32]
Operating Temp. Heating (DB) - °F [°C]	50 to 86 [10 to 30]

Note: Specifications are based on the following conditions:
 Cooling: Indoor temperature of 80°F (26.7°C) DB/67°F (19.4°C) WB, and outdoor temperature of 95°F (35°C) DB/75°F (23.9°C) WB. Heating: Indoor temperature of 70°F (21.1°C) DB/60°F (15.6°C) WB, and outdoor temperature of 47°F (8.3°C) DB/43°F (6.1°C) WB. Pipe length: 25ft. (7.5m), Height difference: 0ft. (0m) (Outdoor unit - indoor unit).



Fujitsu General America, Inc.
 353 Route 46 West
 Fairfield, NJ 07004
 Toll Free: (888) 888-3424
 Fax: (973) 836-0453
 www.airstagevrf.com

Floor (9000 BTU) Indoor Unit
For Heat-recovery/Heat-pump Airstage VRF System

DIMENSIONS

Unit: In. (mm)

Front view

Bottom view

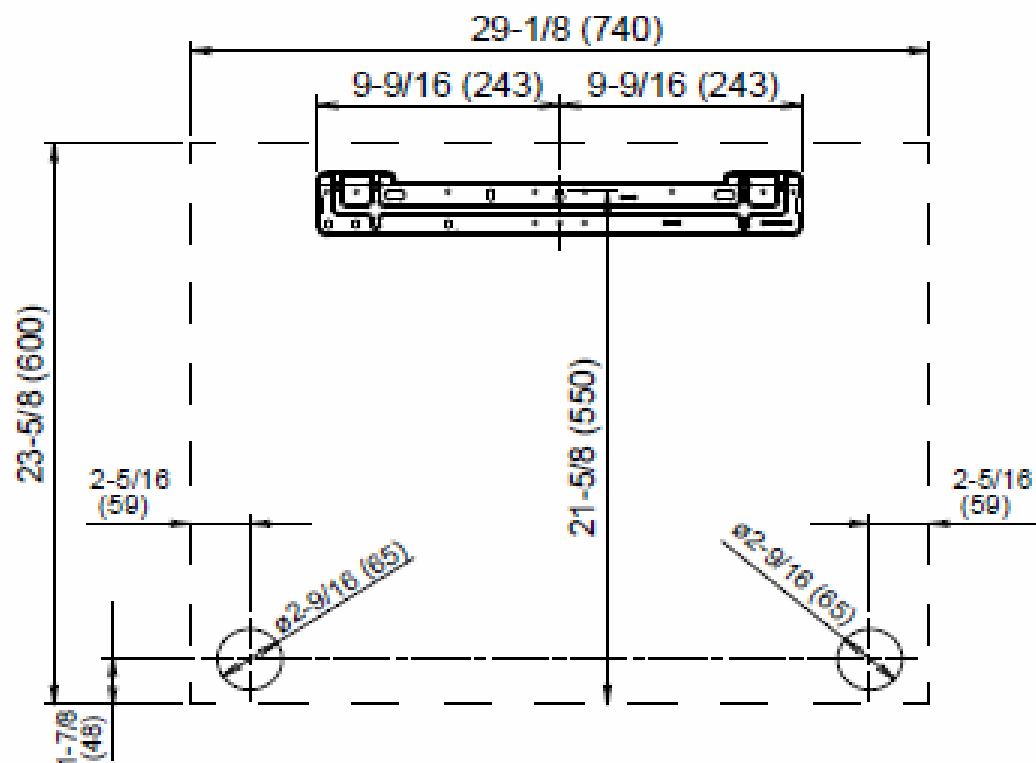
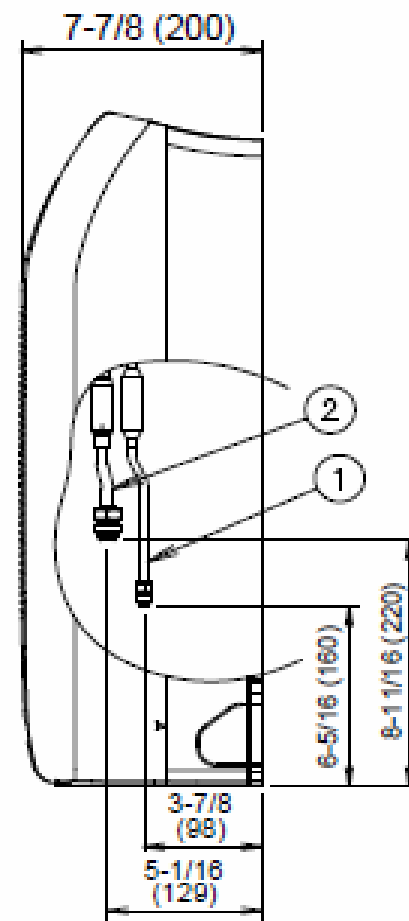
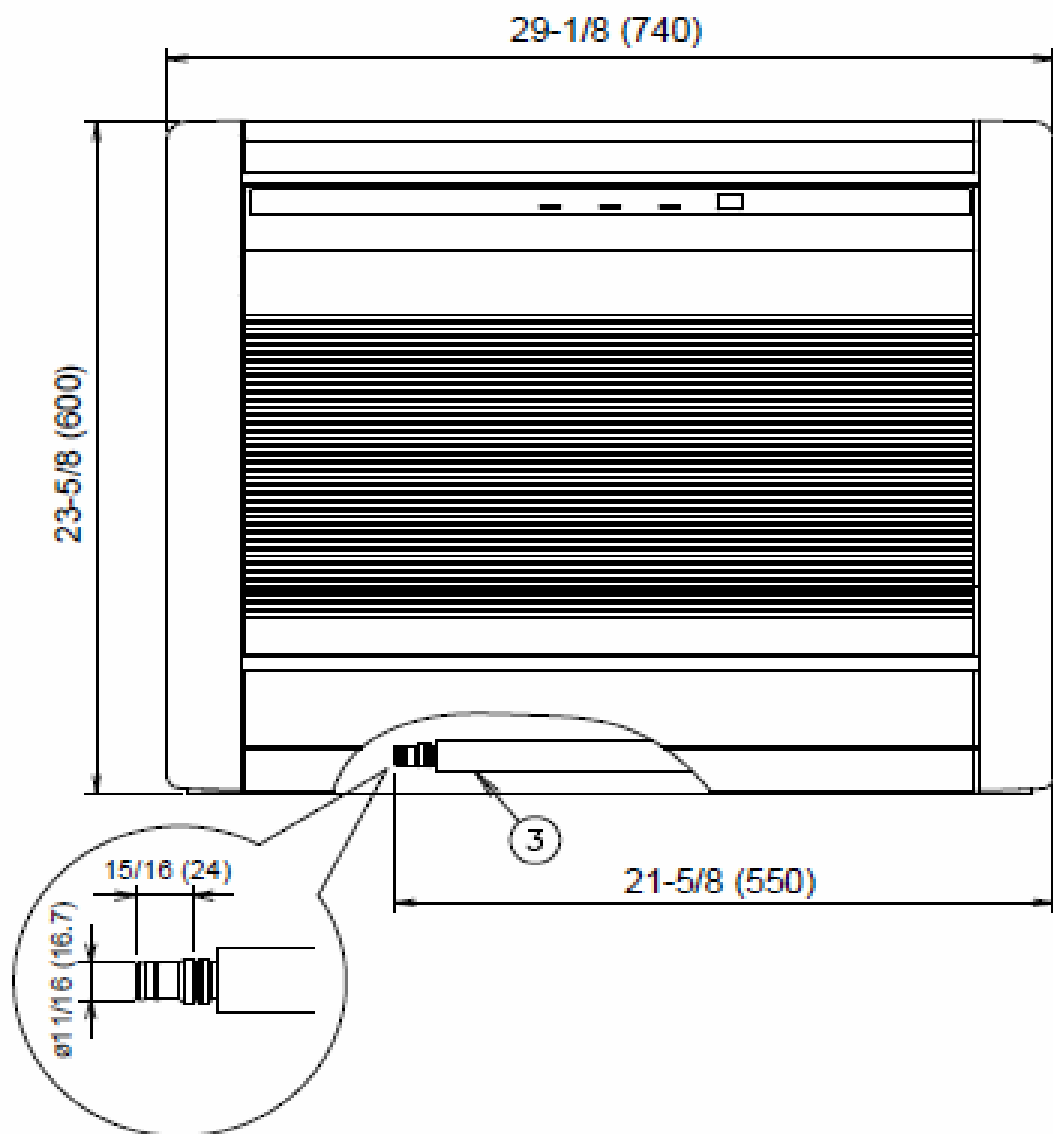

Fujitsu General America, Inc.
353 Route 46 West
Fairfield, NJ 07004
Toll Free: (888) 888-3424
Fax: (973) 836-0453
www.airstagevrf.com