

Floor / Ceiling (18,000 BTU) Indoor Unit For Heat-recovery/Heat-pump Airstage VRF System

Job Name _____
 Location _____
 Engineer _____
 Submitted To _____
 Submitted By _____
 Reference _____

Date _____
 Approval _____
 Construction _____
 Unit No _____
 Drawing No _____

FEATURES

- Flexible design, unit can be suspended from ceiling or mounted on floor
- Quiet and powerful airflow
- Louver auto-swing in two directions
- Auto-closing louvers
- Very low power usage
- Built-in IR Receiver
- Auxiliary heat operation capability
- 10 year Extended Warranty on parts and compressor. See Warranty Statement.



PIPING ACCESSORIES

UTP-AX090A	Separation Tube - 2-Pipe - 90 MBH or Less
UTP-AX180A	Separation Tube - 2-Pipe - 91 to 180 MBH
UTP-AX567A	Separation Tube - 2-Pipe - 180 MBH or More

CONTROLLER

UTY-RNRUZ2	Individual Touch Panel Controller (Wired Remote)
UTY-RSRY	Simple Remote (WITH Master Control) 2-Wire
UTY-RHRY	Simple Remote (WITHOUT Master Control) 2-Wire
UTY-RHKU	Simple Remote (WITHOUT Master Control) (1/16 units)
UTY-LNHU	Wireless Remote Controller (requires IR Receiver)

UTY-DCGY	Central Remote Controller (100 units)
UTY-DTGYZ1	Touch Panel Controller with Internet (400 units)

ACCESSORIES

#N/A	#N/A
UTY-TEKX	External Switch Controller. Use with 3-Wire remotes only.
UTY-XSZX	Remote Sensor for ducted units

WEIGHT AND DIMENSIONS

Enclosure - Net Weight - lbs [kg]	57 [26]
Enclosure - Gross Weight - lbs [kg]	79 [36]
Dimensions - Net (H x W x D) - in [mm]	7-13/16 x 39 x 25-13/16 [199 x 990 x 655]
Dimensions - Gross (H x W x D) - in [mm]	12-5/8 x 45-1/4 x 31-1/8 [320 x 1,150 x 790]

CAPACITY

Capacity - Cooling - Btu/h [kW]	18,000 [5.3]
Capacity - Heating - Btu/h [kW]	20,000 [5.9]

ELECTRICAL

Power Source	208 / 230V, 1-Phase, 60Hz
Available Voltage Range - VAC	187 to 253
Input Power - W	74
Full Load Amps - FLA - A	0.57
Max Circuit Breaker - A	15
Minimum Circuit Ampacity - MCA - A	0.71
Fuse - A (V)	3.15 (250)

FAN

Fan Type	2X (Sirocco)
Airflow Rate - High - CFM [m ³ /h]	589 [1,000]
Airflow Rate - Medium - CFM [m ³ /h]	424 [720]
Airflow Rate - Low - CFM [m ³ /h]	341 [580]

SOUND PRESSURE

Sound Pressure Level - dB(A)	35/39/46
------------------------------	----------

WIRING

Communication Cable	LonWorks (Fujitsu Pink Cable. See AE Bulletin 009)
---------------------	--

PIPING

Connection Pipe Diameter - Liquid (Flare) - in [mm]	ø 3/8 [9.52]
Connection Pipe Diameter - Gas (Flare) - in [mm]	ø 5/8 [15.88]
Connection Pipe Diameter - Drain (ID; OD) - in [mm]	ø 3/4 [19]
Drain-Pump	Optional

ETL

E.T.L.	91987
--------	-------

TEMPERATURE SETTINGS

Operating Temp. Cooling (DB) - °F [°C]	64 to 90 [18 to 32]
Operating Temp. Heating (DB) - °F [°C]	50 to 86 [10 to 30]

Note: Specifications are based on the following conditions:
 Cooling: Indoor temperature of 80°F (26.7°C) DB/67°F (19.4°C) WB, and outdoor temperature of 95°F (35°C) DB/75°F (23.9°C) WB. Heating: Indoor temperature of 70°F (21.1°C) DB/60°F (15.6°C) WB, and outdoor temperature of 47°F (8.3°C) DB/43°F (6.1°C) WB. Pipe length: 25ft. (7.5m), Height difference: 0ft. (0m) (Outdoor unit - indoor unit).



Fujitsu General America, Inc.
 353 Route 46 West
 Fairfield, NJ 07004
 Toll Free: (888) 888-3424
 Fax: (973) 836-0453
 www.airstagevrf.com

SUBMITTAL ABUA18TLAV

Floor / Ceiling (18,000 BTU) Indoor Unit
For Heat-recovery/Heat-pump Airstage VRF System

DIMENSIONS

Unit: In. (mm)

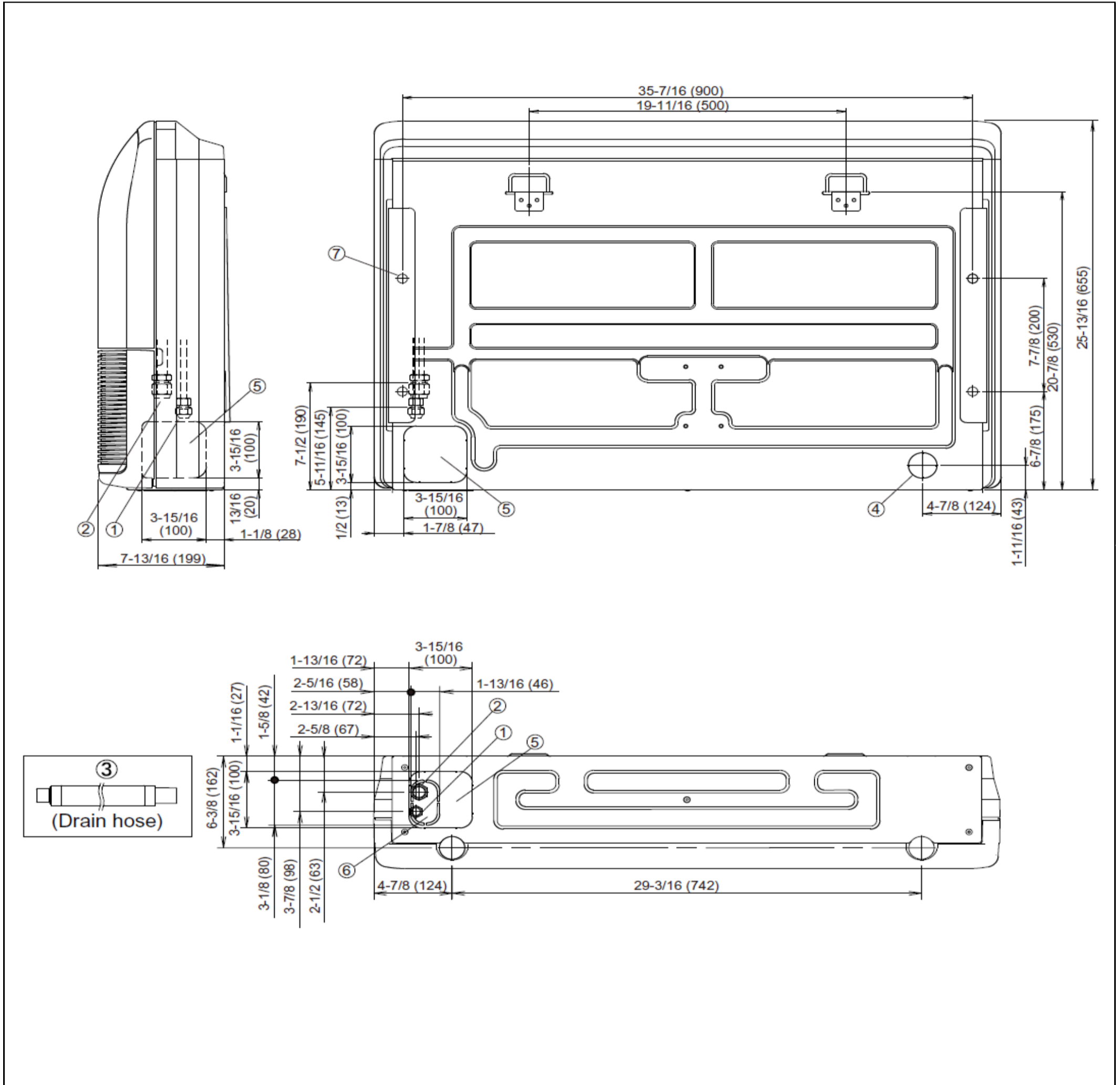

Fujitsu General America, Inc.
353 Route 46 West
Fairfield, NJ 07004
Toll Free: (888) 888-3424
Fax: (973) 836-0453
www.airstagevrf.com