

Light Commercial & Commercial, Residential VRF

VRF systems provide air conditioning solutions that meet the requirements of a diverse range of buildings.

VRF systems provide air conditioning solutions for large residences as well as large commercial buildings.

V-002 VRF J Series Overview
V-004 VRF V Series Overview
V-006 VRF Outdoor Units Lineup
V-008 Features

VRF Outdoor Units



VRF J Series Heat Pump for Small-Capacity Type

V-022 VRF J-IVL
V-028 VRF J-IV
V-032 VRF J-IVS



VRF V Series Heat Recovery Modular Type

V-036 VRF VR-IV

Heat Pump Modular Type

V-046 VRF V-IV

VRF INDOOR UNITS

V-054 VRF Indoor Units Lineup
V-056 VRF Indoor Units



VRF

Light Commercial
& Commercial,
Residential



FUJITSU GENERAL (Euro) GmbH participates in the ECP program for VRF. Check ongoing validity of certificate: www.eurovent-certification.com

FUJITSU GENERAL LIMITED

VRF J Series Overview

Fujitsu General provides air conditioning systems for a wide range of applications, from residences, small offices, hotels, to large retailers.



Maximum **18 HP** Heat Pump

VRF J-IVL

J-IVL is an outdoor unit with a slim design. Its flexibility in installation makes it ideal for midsize office buildings and hotels. With the newly added 14/16/18 HP models, up to 42 indoor units* are connectable, making them ideal for hospitals and educational facilities with many rooms.

*: 18 HP model

Slim Outdoor Unit

Although the new 14/16/18 HP models support slightly higher capacities, they have a slim depth of just 480 mm. This means they can be installed even in tight spaces.

Small room application

The optimum heat exchanger structure allows up to 20-42 indoor units to be connected to an outdoor unit, easily accommodating a number of small rooms

Class-leading Low Operating Sound

The top-class low operating noise makes it ideal for use in densely populated areas.

Maximum **6 HP** Heat Pump

VRF J-IV

J-IV is connectable with up to 14 indoor units, making it suitable for commercial facilities housing a number of small stores.

High energy efficiency

Heat pump inverter control achieves efficient cooling and heating operation for any combination of indoor units.

Flexible system configuration for small and midsize buildings

The space saving design and long pipe connection enable flexible installation on the roof or balcony of a small or midsize building. Multiple indoor units of various capacities and types can be connected.



Maximum **6 HP** Heat Pump, Compact Design

VRF J-IVS

The 998 mm compact design does not obstruct the view even when installed underneath a waist-high window, ideal for large houses and retail stores.

Spaces saving and low sound level design

Economical individual air conditioning is achieved by ALL-DC technology, large-capacity DC twin-rotary compressor, and 3-row heat exchanger, despite the compact size.

Flexible system configuration for homes, stores, and small buildings

The compact size and flexible pipe design make the J-IVS Series an ideal choice for installation in tight spaces in residences, stores, and small offices. Multiple indoor units of various capacities and types can be connected.



8/10/12 HP models

14/16/18 HP models

VRF V Series Overview

VRF V provides air conditioning solutions for large residences as well as large commercial buildings.



Maximum **48 HP** Heat Recovery

VRF VR-IV

Smart, cutting-edge design
Extensive lineup from 8 HP to 48 HP
with the capacity ratio of indoor units connectable up to 150%.

Simultaneous cooling and heating operation using a single refrigerant system

Cooling and heating operations can be selected individually for each indoor unit to provide a comfortable room environment in each room by accommodating widely varying temperatures requirements.

Annual cooling operation

Choose the annual cooling option for rooms and other spaces that require constant temperature control throughout the year.

Accommodating changes in temperature difference

When there are large temperature differences during the day, such as with the change of seasons, the operation mode can be readily changed between heating and cooling.

Maximum **48 HP** Heat Pump

VRF V-IV

Smart, cutting-edge design
Available in a wide range of models from 8 to 48 HP in 2 HP increments with the capacity ratio of indoor units connectable up to 150%.

Excellent energy saving

The inverter heat pump model achieves high energy savings for individual cooling or heating operation by making full use of inverter technology to achieve seasonal efficiency.

High design flexibility for placement in any building

Superb design flexibility meets the diverse installation needs of high-rise buildings for air conditioners, such as a concentrated rooftop installation of outdoor units combined with individual floor installation of indoor units. This flexibility is achieved by large-capacity combination, ample connection capacity, and high static pressure design.

Easy installation and maintenance

The flexible communication method and pipe connections make installation and maintenance easy—even for large systems.

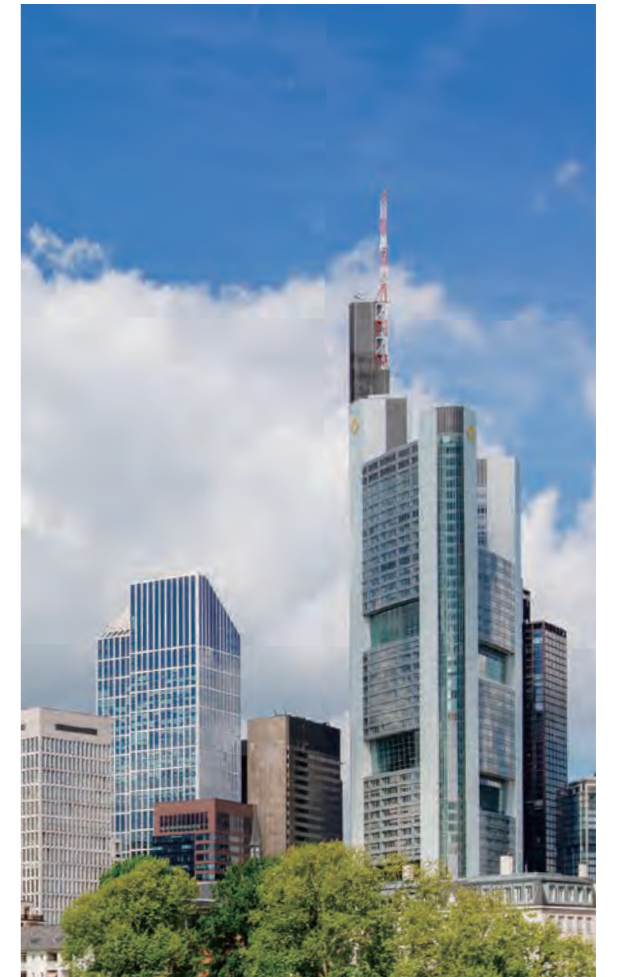

VRF Outdoor Units Lineup

| Capacity (kW) | | 12.1 | 14.0 | 15.1-15.5 | 22.4 | 28.0 | 33.5 | 40.0 | 45.0 | 50.0-50.4 | 55.9 | 61.5 | 67.0 | 73.5 | 78.5 | 85.0 | 90.0 | 95.0 | 100.5 | 107.0 | 112.0 | 118.5 | 123.5 | 130.0 | 135.0 | |
|----------------------------|-------------------|-------------------------------------|------------------------------------|------------------------------------|-----------------|-----------------|-----------------|------------------|-----------------|-----------------|------------------|------------------|------------------|------------------|------------------|------------------|------------------|------------------|------------------|------------------|------------------|------------------|------------------|-----------------|-----------------|--|
| HP | | 4 | 5 | 6 | 8 | 10 | 12 | 14 | 16 | 18 | 20 | 22 | 24 | 26 | 28 | 30 | 32 | 34 | 36 | 38 | 40 | 42 | 44 | 46 | 48 | |
| J-IVL Series | Space Saving | | | | | | | | | | | | | | | | | | | | | | | | | |
| | Set Model | | | | AJH072 LELDH | AJH090 LELDH | AJH108 LELDH | AJH126 LELDH | AJH144 LELDH | AJH162 LELDH | | | | | | | | | | | | | | | | |
| J-IV Series | Space Saving | | | | | | | | | | | | | | | | | | | | | | | | | |
| | Set Model | AJH040 LBLDH, AJH040 LELDH | AJH045 LBDH, AJH045 LELDH | AJH054 LBDH, AJH054 LELDH | | | | | | | | | | | | | | | | | | | | | | |
| J-IVS Series | Space Saving | | | | | | | | | | | | | | | | | | | | | | | | | |
| | Set Model | AJH040 LCLDH | AJH045 LCLDH | AJH054 LCLDH | | | | | | | | | | | | | | | | | | | | | | |
| VR-IV Series Heat Recovery | Space Saving | | | | | | | | | | | | | | | | | | | | | | | | | |
| | Set Model | | | | AJH072 GALDH | AJH090 GALDH | AJH108 GALDH | AJH126 GALDH | AJH144 GALDH | AJH162 GALDH | AJH180 GALDH | AJH198 GALDH | AJH216 GALDH | AJH234 GALDH | AJH252 GALDH | AJH270 GALDH | AJH288 GALDH | AJH306 GALDH | AJH324 GALDH | AJH342 GALDH | AJH360 GALDH | AJH378 GALDH | AJH396 GALDH | AJH414 GALDH | AJH432 GALDH | |
| | Energy Efficiency | | | | | | | | | | | | | | | | | | | | | | | | | |
| | Set Model | | | | | | | AJH144 GALDHH | | | | AJH198 GALDHH | AJH216 GALDHH | AJH234 GALDHH | AJH252 GALDHH | AJH270 GALDHH | AJH288 GALDHH | AJH306 GALDHH | AJH324 GALDHH | AJH342 GALDHH | AJH360 GALDHH | AJH378 GALDHH | AJH396 GALDHH | | | |
| V-IV Series Heat Pump | Space Saving | | | | | | | | | | | | | | | | | | | | | | | | | |
| | Set Model | | | | AJH072 LALDH | AJH090 LALDH | AJH108 LALDH | AJH126 LALDH | AJH144 LALDH | AJH162 LALDH | AJH180 LALDH | AJH198 LALDH | AJH216 LALDH | AJH234 LALDH | AJH252 LALDH | AJH270 LALDH | AJH288 LALDH | AJH306 LALDH | AJH324 LALDH | AJH342 LALDH | AJH360 LALDH | AJH378 LALDH | AJH396 LALDH | AJH414 LALDH | AJH432 LALDH | |
| | Energy Efficiency | | | | | | | | | | | | | | | | | | | | | | | | | |
| | Set Model | | | | | | | AJH144 LALDHH | | | AJH180 LALDHH | | AJH216 LALDHH | AJH234 LALDHH | AJH252 LALDHH | AJH270 LALDHH | AJH288 LALDHH | AJH306 LALDHH | AJH324 LALDHH | AJH342 LALDHH | AJH360 LALDHH | AJH378 LALDHH | AJH396 LALDHH | | | |



Features

High-efficiency

High-efficiency is achieved significantly by the use of a DC twin-rotary compressor, inverter technology, and a large heat exchanger.



DC twin-rotary compressor

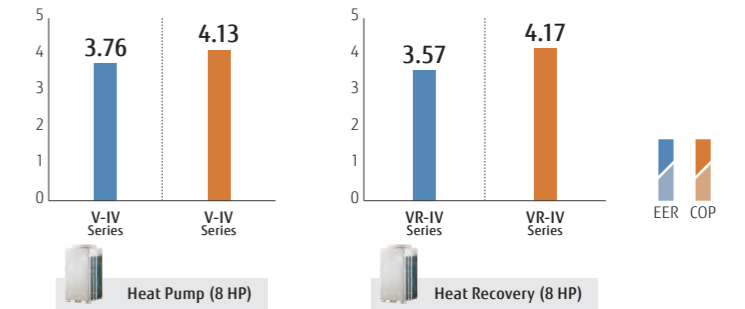

* These specifications are determined by ducted combination.

ALL DC High-efficiency design with top-class SEER/SCOP

All the VRF Series, including the J-IVL Series, have DC technology to achieve high-efficiency operation. This enhances the durability and reliability of the VRF Series.

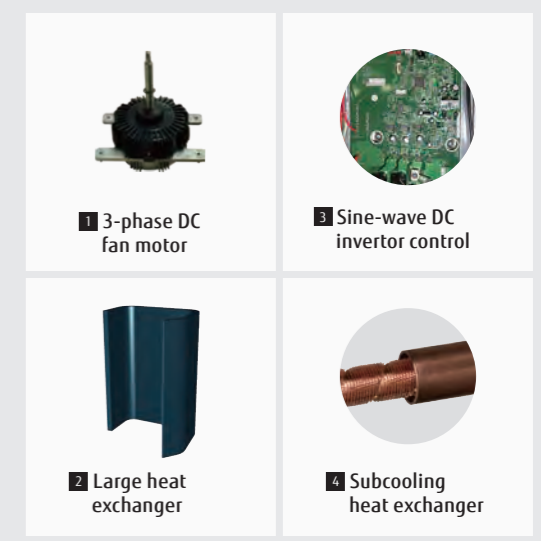

Efficient control of operation

Setting temperature range limitation

Sets the minimum and maximum limits on room temperature to establish an optimum balance between energy-saving performance and a comfortable environment.

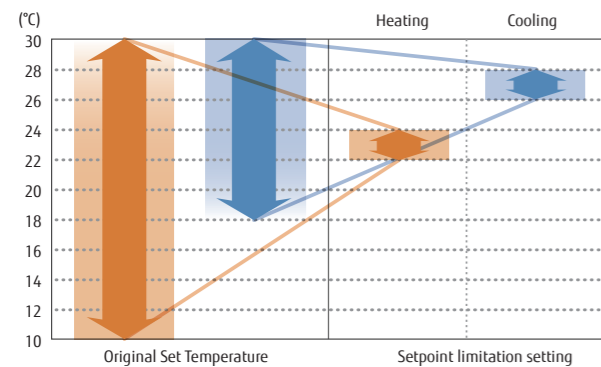

Auto-off timer

The wired remote controller is equipped with an auto-off timer function that automatically stops operation after a fixed period of time has elapsed from the start of operation to avoid wasting energy. The function also allows you to set the interval for stopping operations.

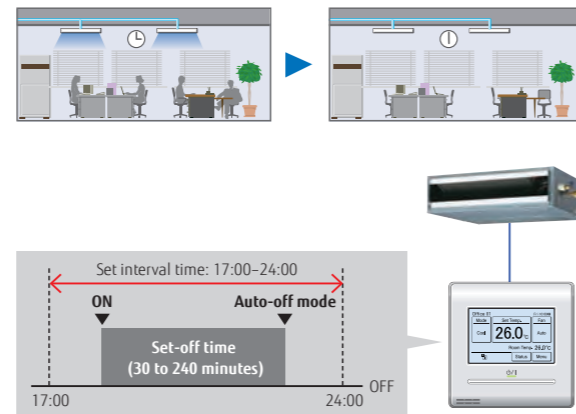

Energy-saving management

A variety of energy-saving operations can be set and managed depending on the season, climate, and time period. Excellent energy-saving operation using the system controller.

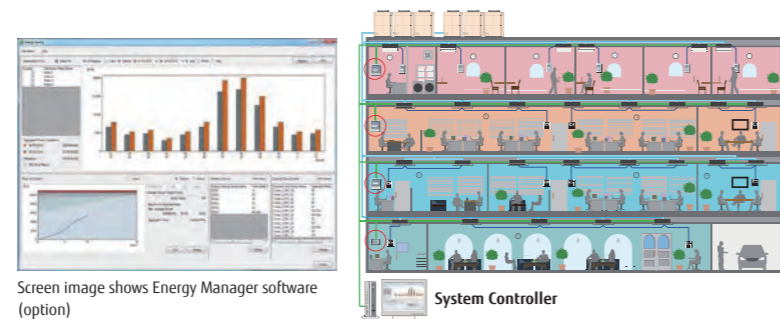

Capacity-saving mode

Operation capacity can be reduced in 5 steps from the rated capacity. This mode cuts down on peak power consumption and eases the maximum load on the unit.

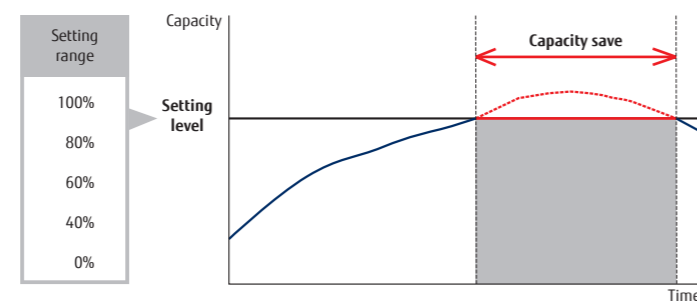

Intelligent refrigerant control

Fujitsu General is proposing outdoor units equipped with refrigerant control function. The refrigerant control operates with subtle control corresponding to the heat load of the room and offers a more comfortable environment. The refrigerant control can also provide increased energy savings.

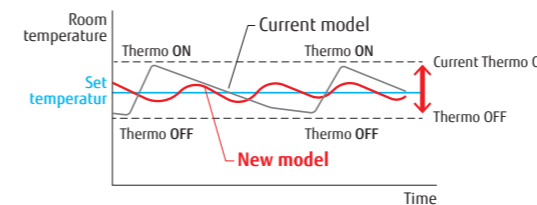

Current refrigerant control

Thermostat-ON/OFF occurs frequently. → Frequent changes in room temperature interfere with comfort. The compressor starts and stops repeatedly, wasting energy.

New refrigerant control

The thermostat is turned on and off less frequently than under current control to maintain the room temperature at the target temperature. Compared to current control, the compressor will run longer, thus saving energy.

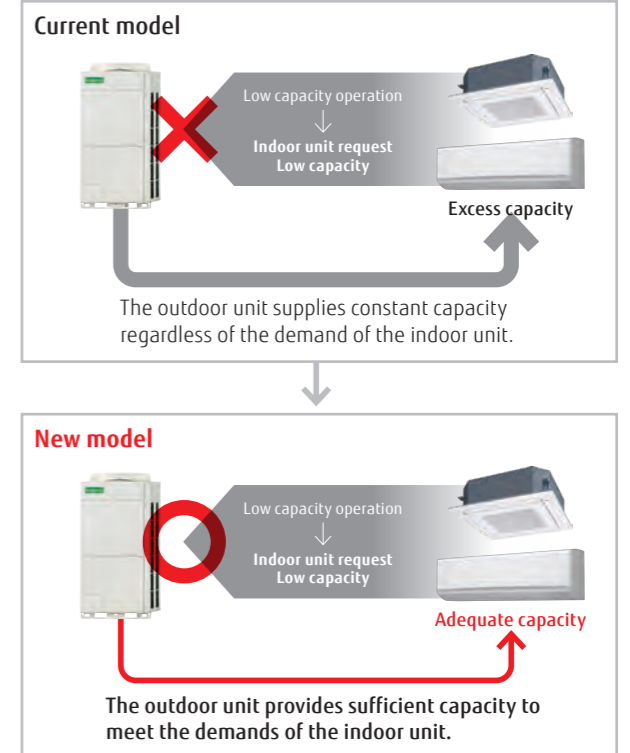

* The improvements due to the control and the actual sine wave vary depending on the combination of the indoor unit and system operating conditions.

More Comfort



Auto changeover

In Auto setting, the air conditioner switches between cooling and heating modes automatically according to the set temperature and the room temperature.

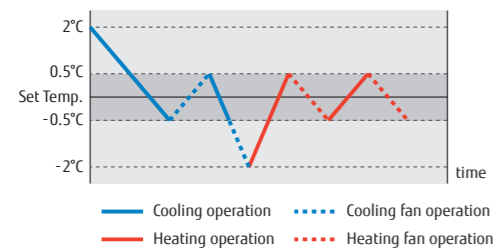

Auto changeover settings enable the indoor unit to easily switch between cooling and heating regardless of the operating mode of other indoor units. These settings can be made using a wired remote controller for a specific indoor unit. Provides a comfortable environment all year round.

Automatic cooling/heating operation for each room is possible

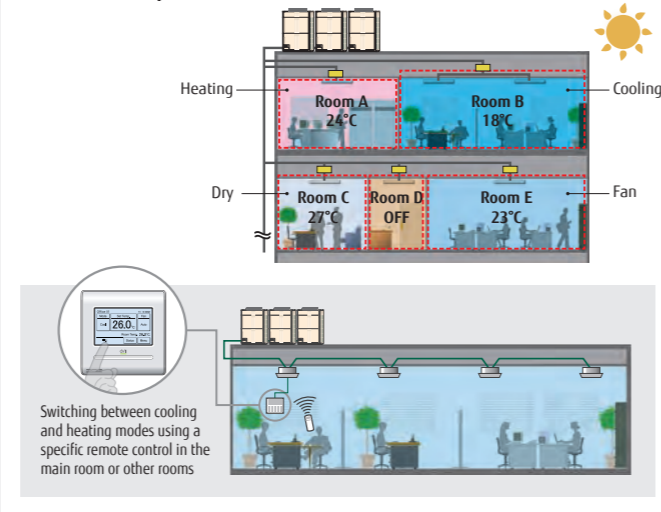

Precise control of refrigerant flow

The combination of DC inverter control and individual control of electronic expansion valves of an indoor unit enables precise and smooth control of the refrigerant flow. This means the room temperature can be set in increments of 0.5°C.

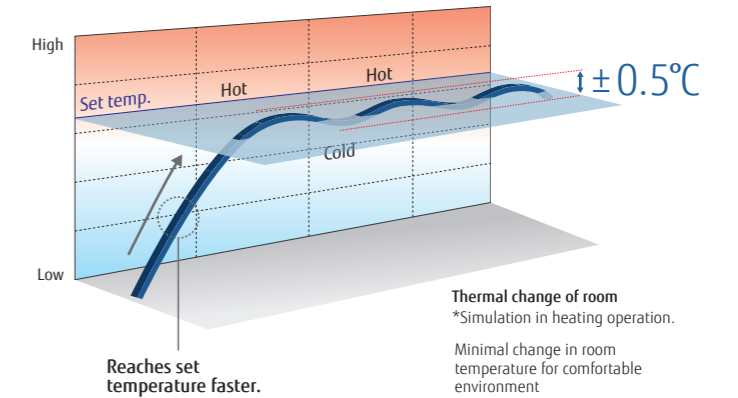

Quiet operation

Quiet operation

Two low noise modes can be switched over automatically between one in which low noise is prioritized over performance, and the other in which performance is prioritized over low noise, depending on the room temperature and outdoor temperature. This feature can be controlled by external input from the outdoor unit or a system controller.

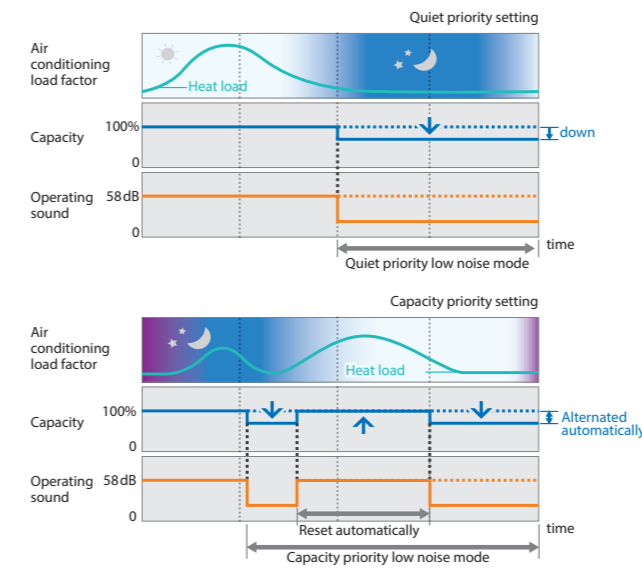

Non-stop oil recovery operation

A comfortable room condition is maintained during oil recovery mode because the product continues to operate without stopping the cooling or heating operation.

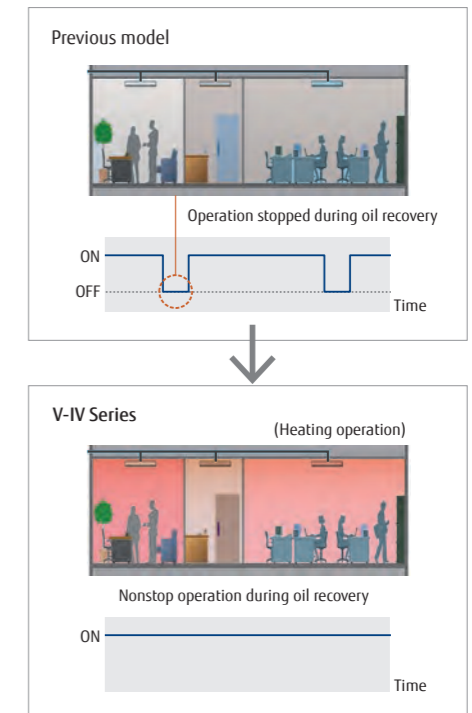

Low noise design

Small-capacity indoor units meet a variety of applications. Super low noise operations offer greater audibility comfort. In particular, the low static pressure duct (04 model) has a noise level of only 20 dB(A) during quiet mode.



Small-capacity indoor unit

High Reliability

Outdoor unit rotation

The compressor starting order is rotated to equalize the cumulative running time of each unit.

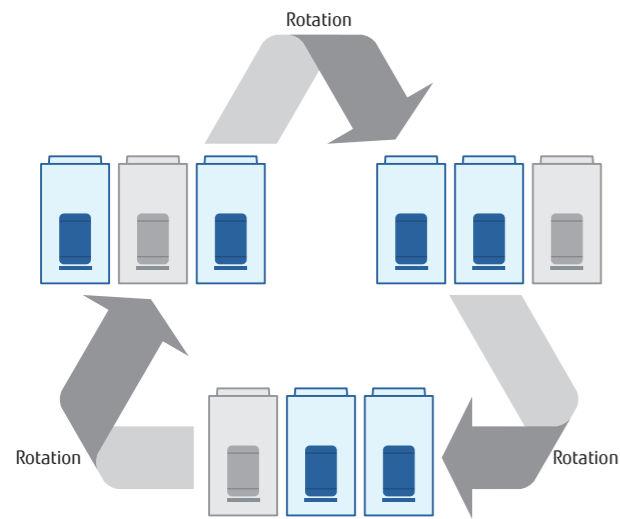

The start and stop timings are alternated among connected compressors.

Backup operation

If one compressor fails, the other compressors will initiate backup operation*.

Note: Backup operation may not be possible depending on the cause of failure.

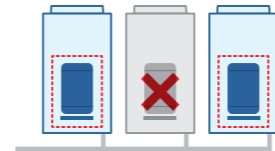

Advanced refrigerant control

Compressor control logic controls the inverter speed to balance the mass airflow rate of refrigerant in each outdoor unit.

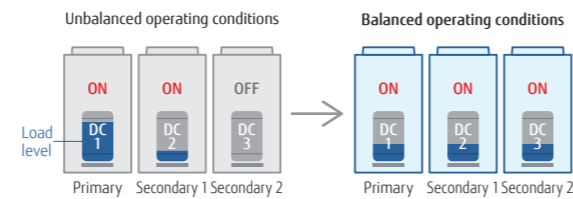

Protection against liquid flowback

The use of a large accumulator means that refrigerant that has not been completely vaporized stays inside the accumulator to ensure no liquid refrigerant is fed into the compressor.

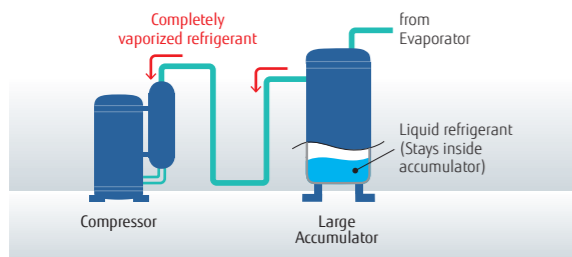

Blue fin heat exchanger

The anti-corrosion blue fin treatment is applied to the heat exchanger of the outdoor unit.

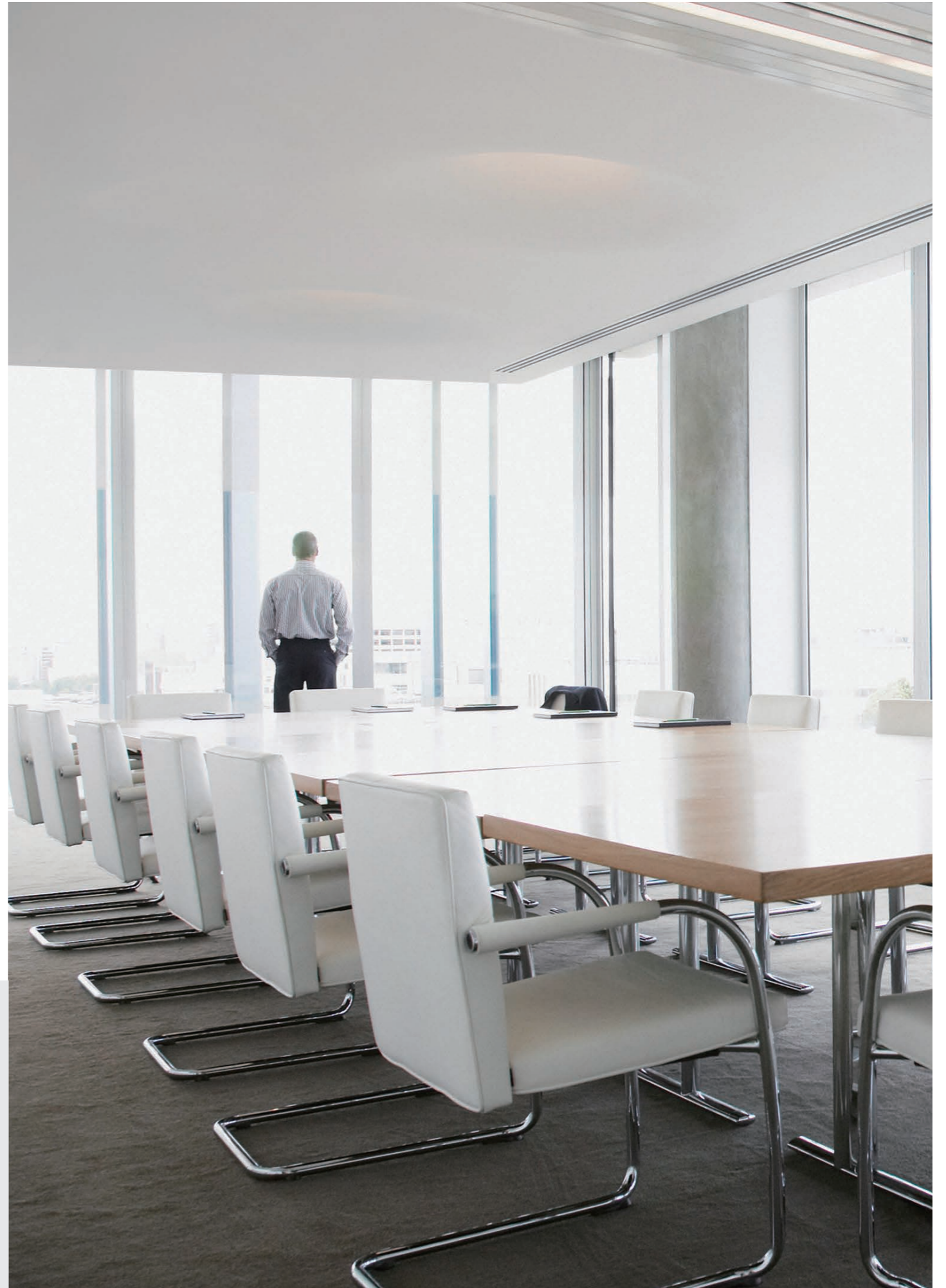
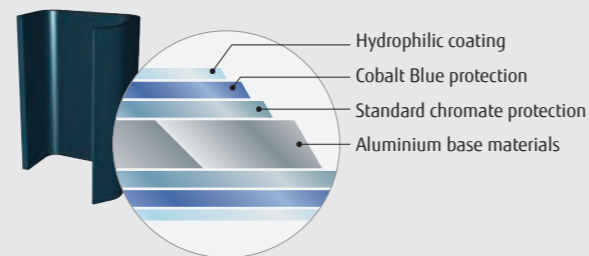

Design flexibility

Class-leading compact design

An industry-leading compact outdoor unit with optimal airflow pattern design. (Up to 18 HP)



Long pipe design

Pipe design suitable for long and narrow office buildings with elevation differences and low-rise stores with long distances (VRF J-IVL Series)

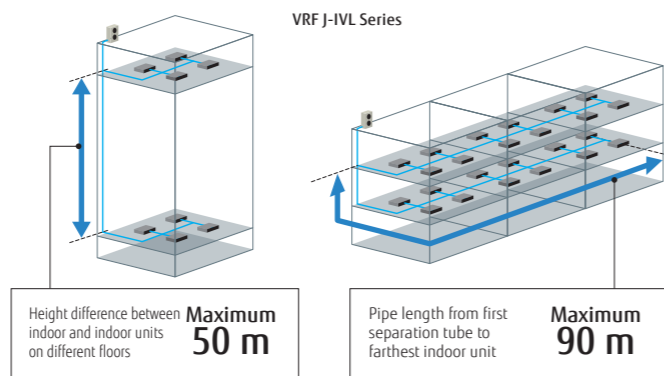

Max. allowable overall pipe length: 1,000 m

The class-leading pipe length of 1,000 m increases flexibility of installation in a wide variety of buildings.

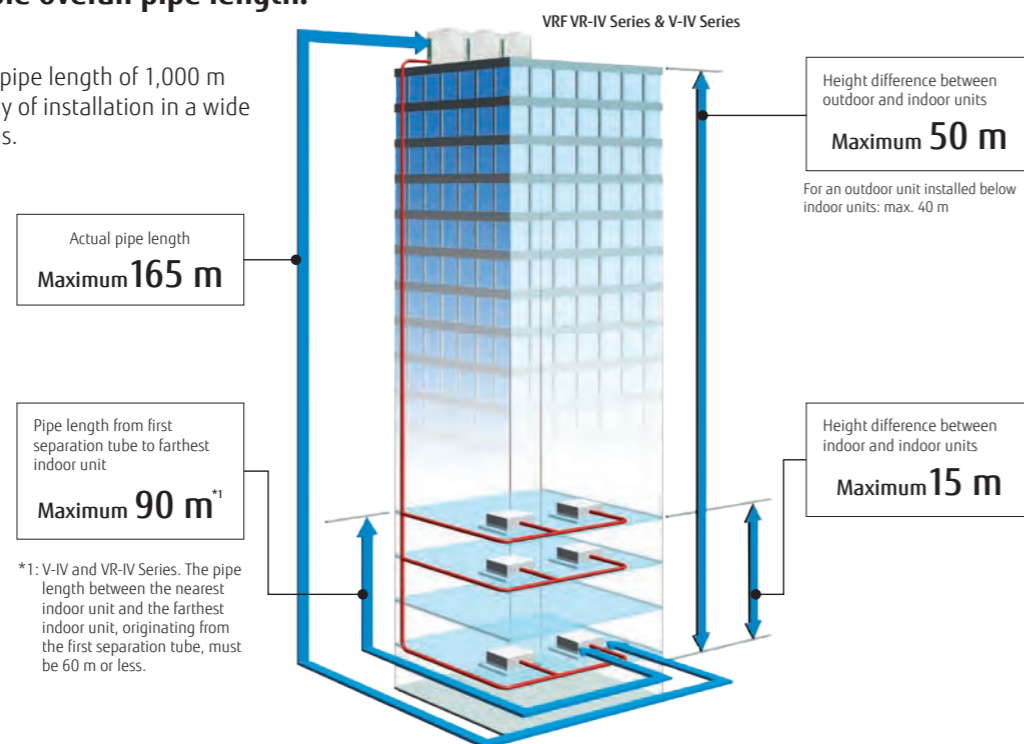

High-capacity connection

| Series | Connectable indoor unit capacity range | Connectable indoor units |
|---|---|--------------------------|
| VRF J-IVL Series 14/16/18 HP Heat pump type | 50% to 150% ^{*2} | up to 42 ^{*4} |
| VRF J-IVL Series 8/10/12 HP Heat pump type | 50% to 150% ^{*2} | up to 30 ^{*5} |
| VRF J-IV Series Heat pump type | 50% to 150% ^{*2} | up to 14 ^{*6} |
| VRF J-IVS Series Heat pump type | 50% to 130% ^{*2} | up to 13 ^{*7} |
| VRF VR-IV Series Heat Recovery Modular type | 25% ^{*7} to 150% ^{*2} | up to 64 |
| VRF V-IV Series Heat Pump Modular type | 50% to 150% ^{*3} | up to 64 |

^{*2}: Conditions for the maximum capacity ratio of connectable indoor units are shown in the chart above.
^{*3}: The maximum capacity of the combination that includes the 18-HP outdoor unit is below 150%.
^{*4}: J-IVL Series 18-HP model only.
^{*5}: J-IVL Series 12-HP model only.
^{*6}: J-IV Series 6-HP model only.
^{*7}: J-IVS Series 6-HP model only.

Designed for low refrigerant charge

The optimal design of the indoor and outdoor units reduces the amount of refrigerant required and can be easily installed in a room as small as 15 m².



Various optional parts

- Fresh air intake kit to bring in fresh air
- Comfortable temperature control with a remote sensor
- DX kit links ventilation equipment and air handling units.

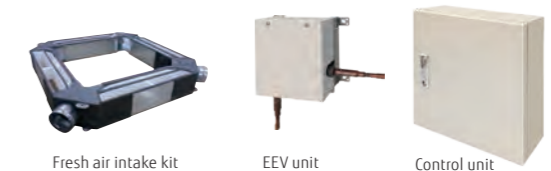

Low ambient operation

Our refrigeration cycle technology enables cooling operation even at -15°C.



Wide operating temperature range

All outdoor units have a wide operating temperature range and can operate in extreme temperature conditions.

^{*8}: When multiple outdoor units are connected, their operating temperature range is from -5°C to 46°C in cooling.
^{*9}: The operating range is -15°C to 46°C only for systems with all indoor units rated at 5.6 kW or more.

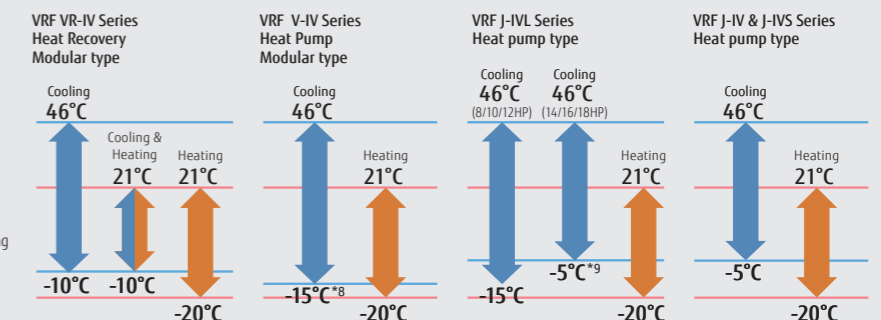

Easy Installation



Easily transported

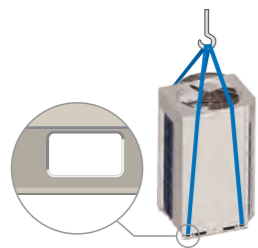

A lifting strap can be hooked onto an outdoor unit
Design of outdoor unit allows for lifting straps to be used

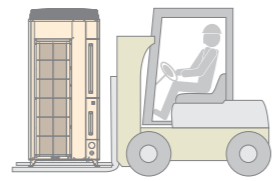

Transportable by forklift
The outdoor unit can be lifted and transported by forklift.

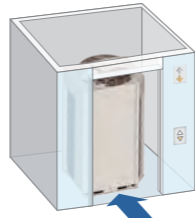

Fits into a small elevator.

Easy access

The removable L-shaped front panel provides more room for installation and service work. Multiple installations can be performed easily and efficiently even in tight spaces.

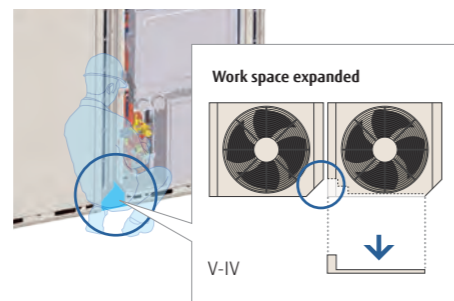

Front access reduces installation intervals

Flexible pipe connection

Piping and wiring can be accessed from the front, left, right, and bottom.



Simplified wiring work

The communication wiring can be installed seamlessly among indoor, outdoor, and RB units, which makes the installation of the wiring system easier.

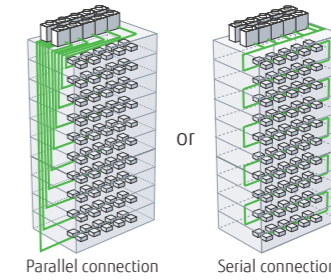

Maximum wiring length:
3,600 m

Note: The automatic address setting is not available on a serially connected multiple refrigerant system.

Vacuum mode function for easy evacuation

The vacuum mode function enables all expansion valves of an indoor unit to be opened fully, allowing for easier evacuation of air inside pipe lines and indoor units.

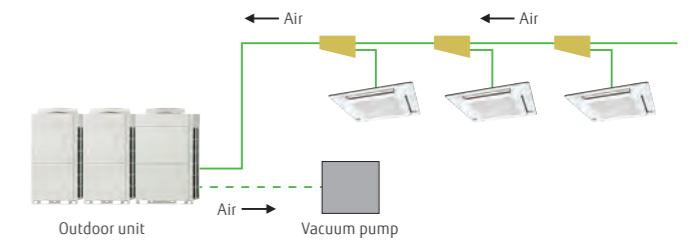

Automatic address setting

Addresses of connected indoor units, RB units, and Signal amplifier can all be set automatically from the PCB in the outdoor unit.

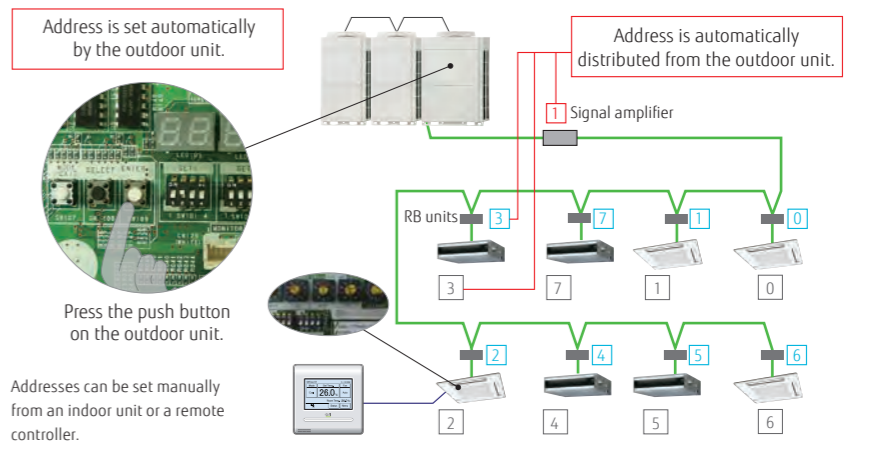

Press the push button on the outdoor unit.
Addresses can be set manually from an indoor unit or a remote controller.

Easy commissioning with Service Tool

The Service Tool checks the refrigerant temperature and pressure, and the operating status of the electronic expansion valves, making it easy to determine if the units are connected properly.



Easy service and maintenance

Designed for easy maintenance

A 7-segment indicator lamp panel provides detailed information on the function setting status, refrigerant temperature and pressure, compressor operation time, and other factors, facilitating self-diagnosis for each unit.

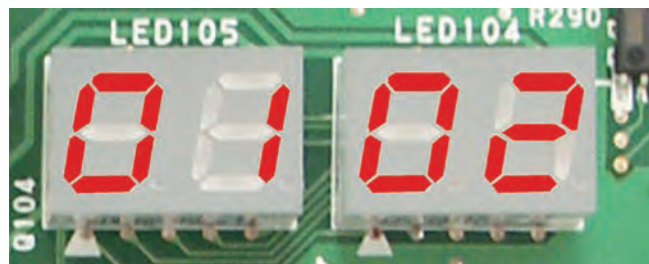

Easy-to-read 7-segment indicator lamp

Shows the following detailed operation and error status without need of any special tools.

Error status can be checked on an outdoor unit's display

- System operation mode
- Discharge temperature and pressure
- Compressor operation status
- Address, type, and number of outdoor unit

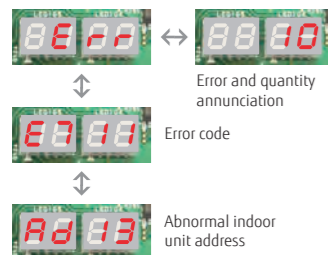

- Error status can easily be checked on an outdoor unit's display.

Movable PCB panel

Enables easier access behind the PCB for maintenance work.

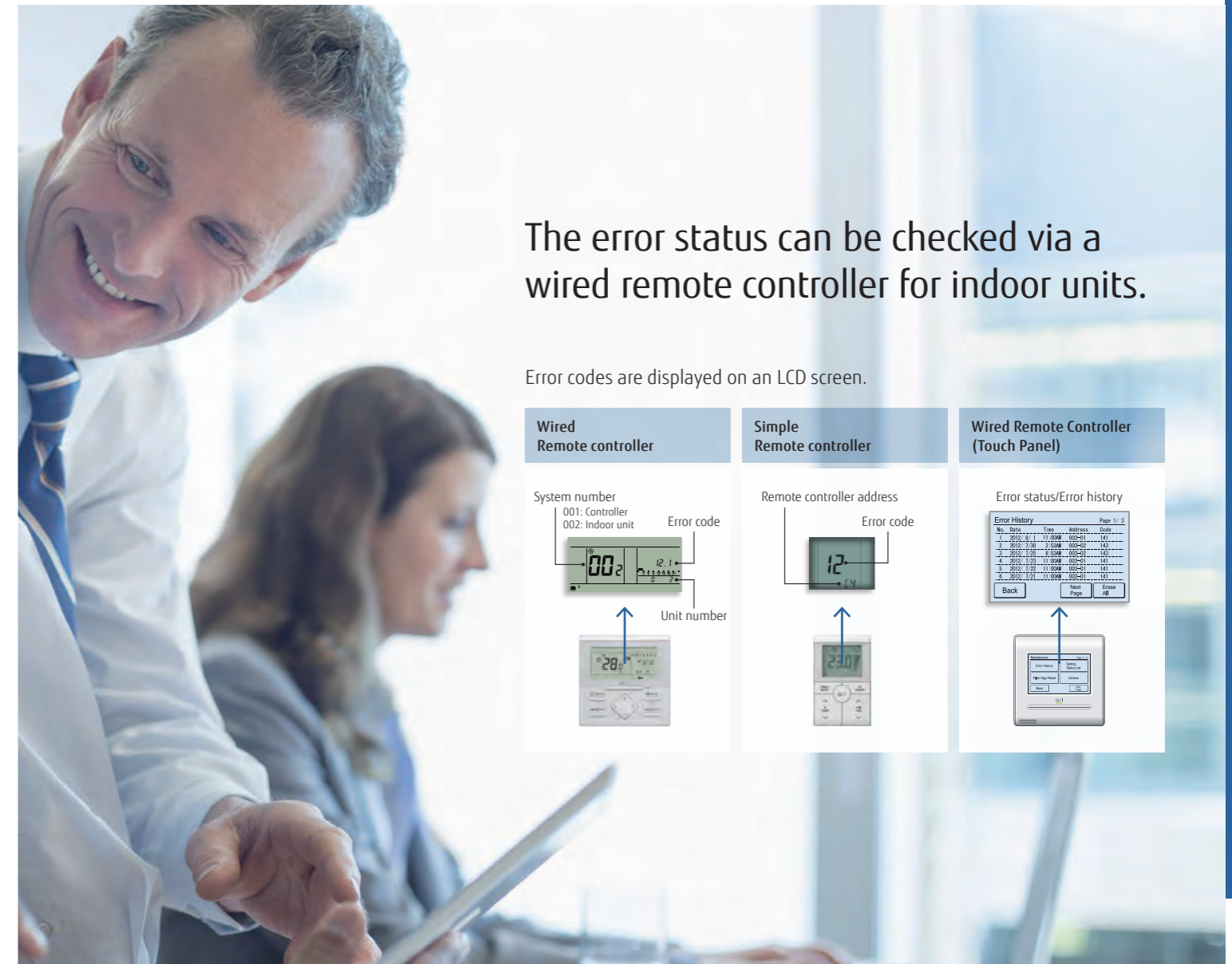

The error status can be checked via a wired remote controller for indoor units.

Error codes are displayed on an LCD screen.

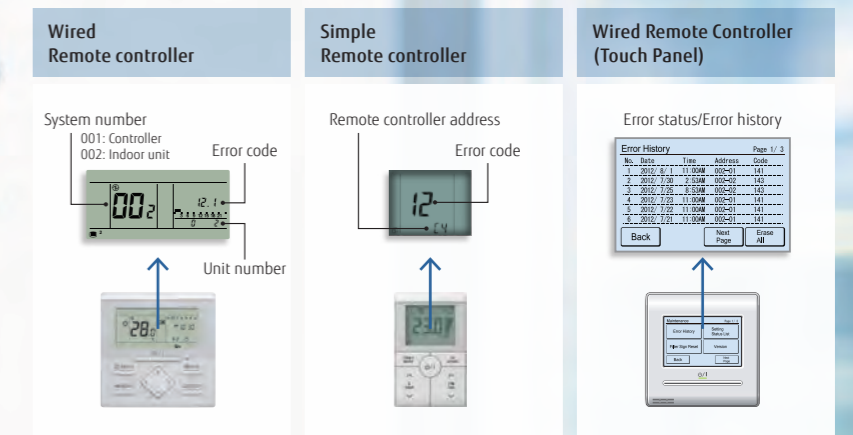

Error diagnosis by Service tool

Connection to Service tool

- A detailed operation status and recent error history can be checked and analyzed using Service tool.
- The last 5 minutes of operation status can be recorded continuously.

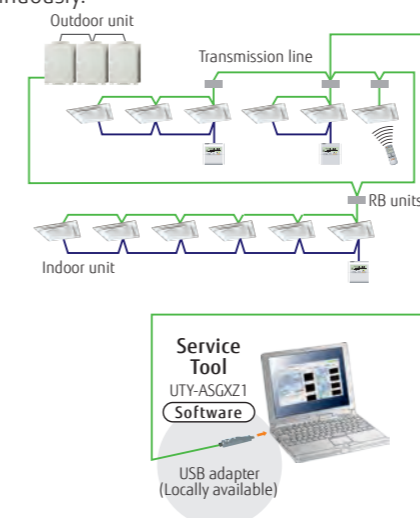

Remote monitoring

The Web Monitoring system enables the monitoring of the system's operation status at any time via the internet to ensure trouble-free operation. The operating VRF network system in the building can be monitored real time over the internet.

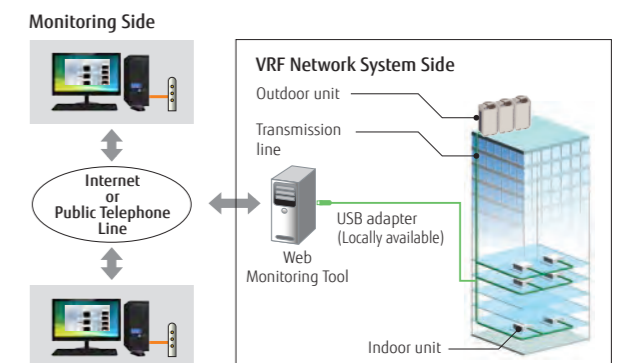

Heat Pump

for Small-capacity type

VRF J-IVL

System configuration example

- Suitable for air conditioning small and medium-size buildings. One refrigerant system is used for each outdoor unit.
- Multiple indoor units are connected with separation tubes and headers.

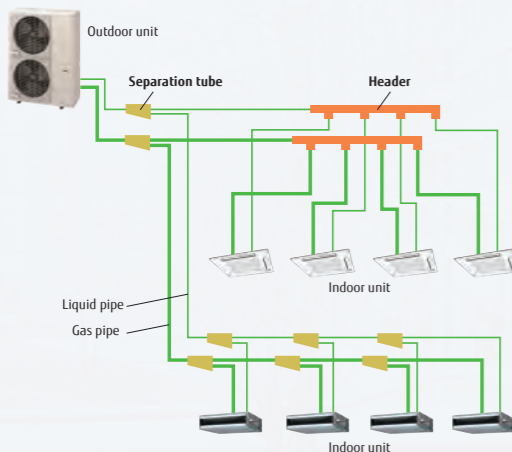

New intelligent refrigerant control

Fujitsu General is proposing outdoor units equipped with refrigerant control function. The refrigerant control operates with suitable control corresponding to the heat load of the room and offers a more comfortable environment. The refrigerant control can also provide increased energy savings.

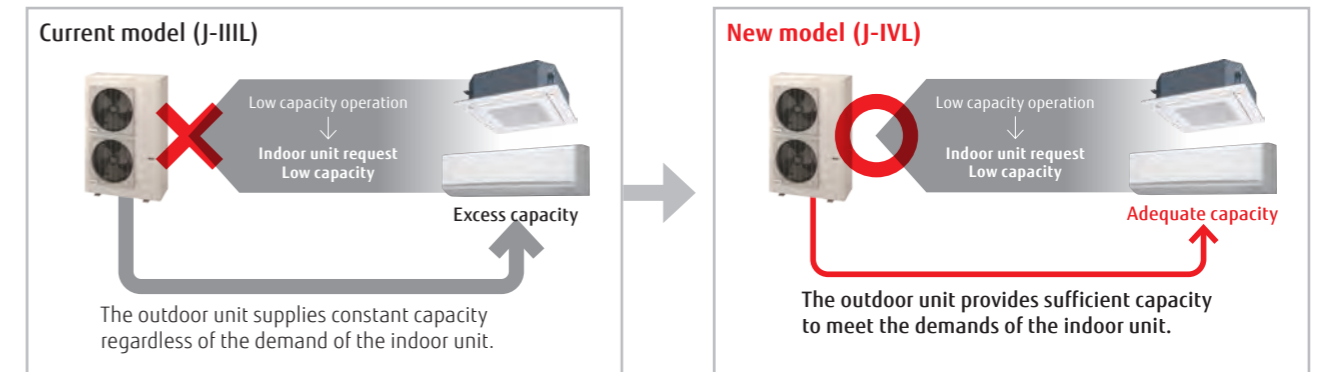

* The improvements due to the control and the actual sine wave vary depending on the combination of the indoor unit and system operating conditions.

External static pressure

External static pressure is available up to 60 Pa for 14/16/18 HP. (30 Pa for 8/10 HP, 40 Pa for 12 HP)

Capacities are slightly decreased relative to the rated values during high static pressure operations.



Advanced high-efficiency technology

Ø570 mm Large propeller fan
A large-diameter propeller fan with our proprietary blade design reduces draft loss, which results in high-efficiency and low noise operation.

DC fan motor
A small, multi-stage DC fan motor provides high-efficiency and low noise operation.

Large heat exchanger
The large 2.6-row heat exchanger substantially improves heat-exchanging performance.

DC inverter control
The active filter module improves efficiency.

Subcooling heat exchanger
The dual-tube heat exchanger improves cooling performance.

Scroll compressor
The combination of a scroll compressor with a wide rotational frequency range from 15 to 130 rps and our proprietary sensorless sine-wave control that smoothly controls the input power into the motor achieves more energy-efficient and quieter operation.

15 to 130 rps

Pressure-enthalpy diagram showing 'effect' and 'Cooling performance improved'.



Fujitsu General offers a perfect total air conditioning system for small office buildings with multiple small rooms, taking into consideration energy savings, low noise, comfortable air volume, usage and purpose, and centralized control.

VRF J-IVL

Image: 8/10/12 HP models

Slim & Compact design



Various installation methods

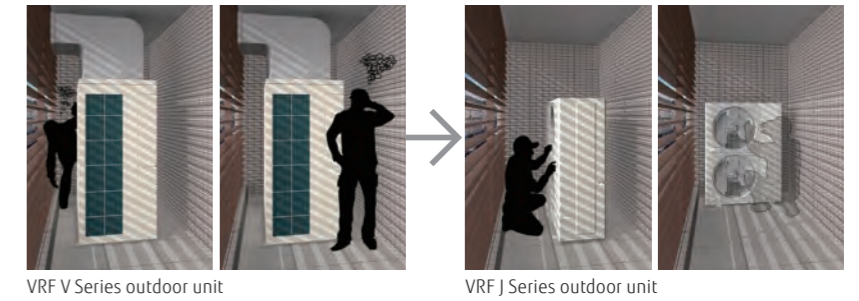

Installation Low noise level in consideration of nearby residents

Front air discharge type with a width of about 1,000 mm, allowing for flexible installation even in narrow spaces.



Narrow space behind building Space saving

Small and thin, allowing for direct ground or wall mounting installations even in narrow alleys.

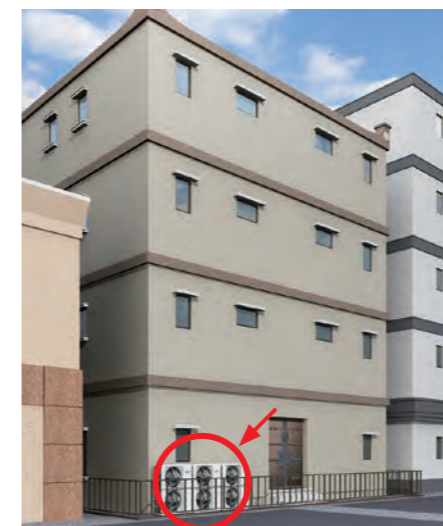

Installation on the back street of a building Flexible installation

Slim, low-body front air discharge meets the requirements for installation even in tight spaces. Installation flexibility without blocking the windows of buildings contributes to substantial space savings, even when multiple units are installed.

Efficiency in actual operating conditions

The use of a large heat exchanger and a high-efficiency Scroll compressor achieves class-leading EER/COP (Max. Heating) in all models.

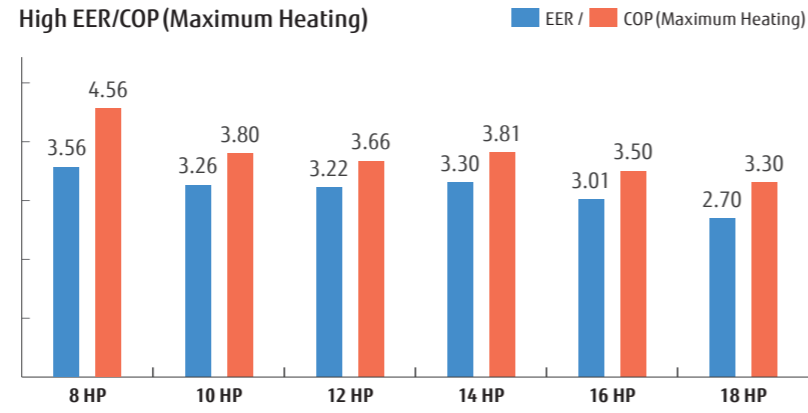

* These specifications are determined by cassette combination.

Long pipe length

Our advanced refrigerant control technology extends the maximum allowable length of refrigerant piping to 400 m. This provides high flexibility in system design.

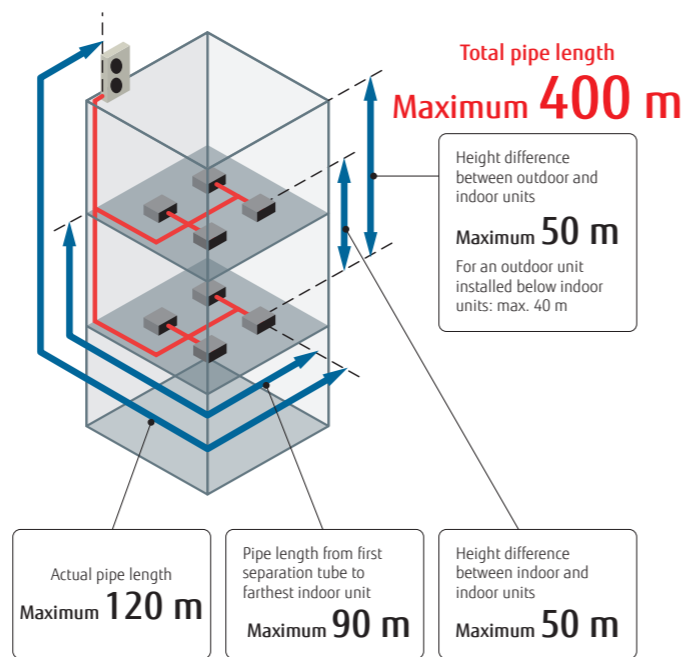

Up to 42 indoor units* can be connected.

The combination of smaller but sufficiently powerful indoor units and a new outdoor unit with an optimized heat exchanging structure makes it possible to connect up to 42 indoor units, which is the best in its class. *: 18 HP model

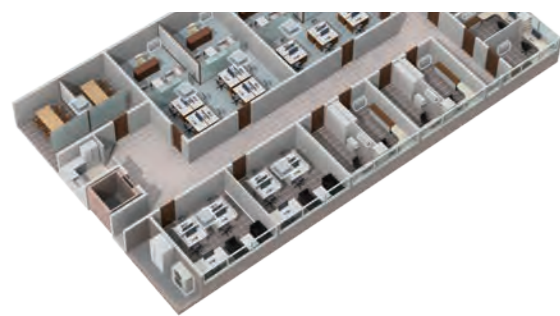

Class-leading low operating sound

The top-class low operating noise makes it ideal for use in densely populated areas. These low operating sound models are ideal for installation in densely populated areas.

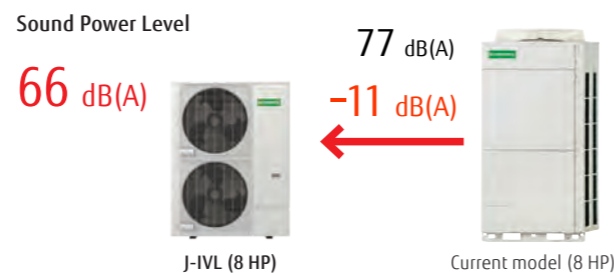

8,10,12 HP: AJH072LELDH / AJH090LELDH / AJH108LELDH
14,16,18 HP: AJH126LELDH / AJH144LELDH / AJH162LELDH



Specifications

| Rated capacity range | | HP | 8 | 10 | 12 | 14 | 16 | 18 |
|-----------------------------------|---------------------------------|--------------|-----------------------------------|---------------|---------------|---------------|---------------|---------------|
| Model name | | | AJH072LELDH | AJH090LELDH | AJH108LELDH | AJH126LELDH | AJH144LELDH | AJH162LELDH |
| Maximum connectable indoor units | | | 1-20 | 1-25 | 1-30 | 1-36 | 1-40 | 1-42 |
| Power source | | | 3-phase, ~400V, 50Hz | | | | | |
| Capacity | Cooling | kW | 22.4 | 28.0 | 33.5 | 40.0 | 45.0 | 50.0 |
| | Nominal Heating | | 22.4 | 28.0 | 33.5 | 40.0 | 45.0 | 50.0 |
| | Max. Heating | | 25.0 | 31.5 | 37.5 | 45.0 | 50.0 | 55.0 |
| Input power | Cooling | kW | 6.30 | 8.59 | 10.42 | 12.12 | 14.96 | 18.52 |
| | Nominal Heating | | 4.65 | 6.61 | 8.18 | 9.71 | 11.81 | 13.66 |
| | Max. Heating | | 5.45 | 8.29 | 10.25 | 11.81 | 14.29 | 16.66 |
| EER | Cooling | W/W | 3.56 | 3.26 | 3.22 | 3.30 | 3.01 | 2.70 |
| | Nominal Heating | | 4.82 | 4.24 | 4.10 | 4.12 | 3.81 | 3.66 |
| | Max. Heating | | 4.56 | 3.80 | 3.66 | 3.81 | 3.50 | 3.30 |
| COP | Cooling | W/W | 7.62 | 7.50 | 7.27 | 7.27 | 7.00 | 6.29 |
| | Nominal Heating | | 3.89 | 3.61 | 3.63 | 3.53 | 3.51 | 3.54 |
| | Max. Heating | | 3.01 | 2.97 | 2.87.8 | 2.87.8 | 2.77.0 | 2.48.6 |
| ηc | Cooling | % | 301.8 | 297.0 | 287.8 | 287.8 | 277.0 | 248.6 |
| | Heating | | 152.6 | 141.4 | 142.2 | 138.2 | 137.4 | 138.6 |
| Airflow rate | Cooling | m³/h | 8,400 | 9,000 | 11,000/12,100 | 13,000 | 14,000 | 14,800/15,300 |
| | Heating | | 52/66 | 54/69 | 59/73 | 62/75 | 64/77 | 65/79 |
| Sound pressure level/ Power level | Cooling | dB(A) | 54/66 | 57/70 | 62/75 | 63/76 | 65/78 | 68/82 |
| | Heating | | 1,428 | 1,428 | 1,428 | 1,638 | 1,638 | 1,638 |
| Net Dimensions | Height | mm | 1,080 | 1,080 | 1,080 | 1,080 | 1,080 | 1,080 |
| | Width | | 480 | 480 | 480 | 480 | 480 | 480 |
| | Depth | | 170 | 177 | 178 | 213 | 213 | 217 |
| Weight | Type (Global Warming Potential) | kg (CO2eq-T) | R410A (2,088) | R410A (2,088) | R410A (2,088) | R410A (2,088) | R410A (2,088) | R410A (2,088) |
| | Charge | | 7.0 (14.6) | 7.5 (15.7) | 7.5 (15.7) | 11.0 (23.0) | 11.0 (23.0) | 11.8 (24.6) |
| Connection pipe diameter | Liquid | mm | 9.52 | 9.52 | 12.70 | 12.70 | 12.70 | 12.70 |
| | Gas | | 19.05 | 22.20 | 28.58 | 28.58 | 28.58 | 28.58 |
| Total pipe length | | m | 400 | 400 | 400 | 400 | 400 | 400 |
| Max. height difference | | | 50/40 (Outdoor unit: Upper/Lower) | | | | | |
| Operating Range | Cooling | °C | -15 to 46 | -15 to 46 | -15 to 46 | -5 to 46* | -5 to 46* | -5 to 46* |
| | Heating | | -20 to 21 | -20 to 21 | -20 to 21 | -20 to 21 | -20 to 21 | -20 to 21 |

Note: Specifications are based on the following conditions.

Cooling: Indoor temperature of 27°CDB / 19°CWB, and outdoor temperature of 35°CDB / 24°CWB.

Heating: Indoor temperature of 20°CDB / 15°CWB, and outdoor temperature of 7°CDB / 6°CWB.

Pipe length: 7.5 m; Height difference between outdoor unit and indoor unit: 0 m.

* The cooling operation range of -15 to 46°C is allowed only when all of the indoor units connected to the system are higher than capacity of 5.6kW.

Dimensions

(Unit: mm)

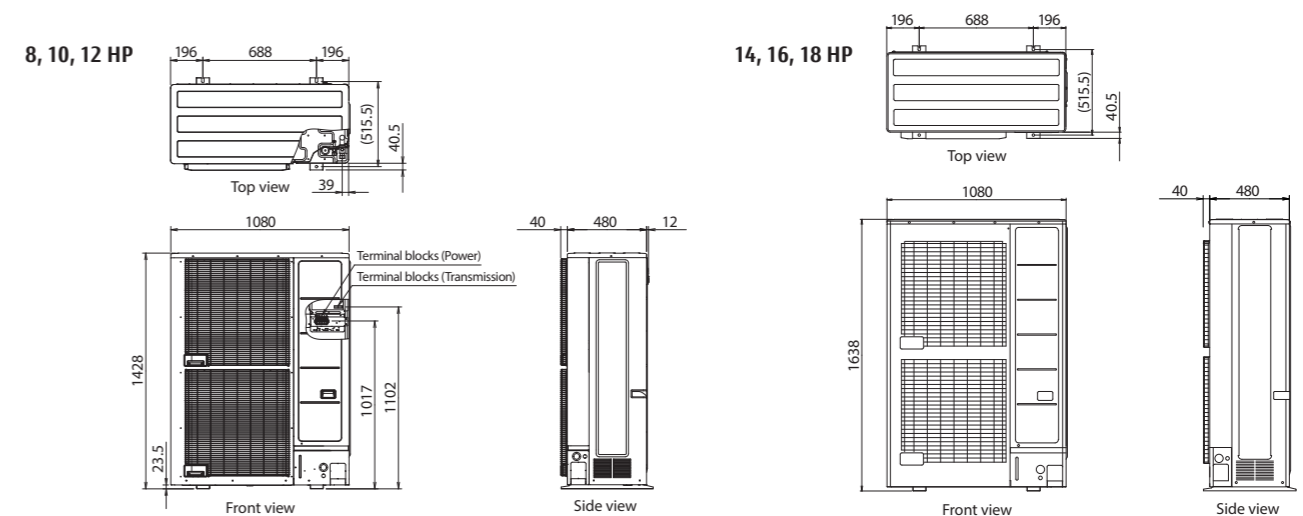

Heat Pump

for Small-capacity type

VRF J-IV

System configuration example

- Suitable for air conditioning small and medium-size buildings. One refrigerant system is used for each outdoor unit.
- Multiple indoor units are connected with separation tubes and headers.

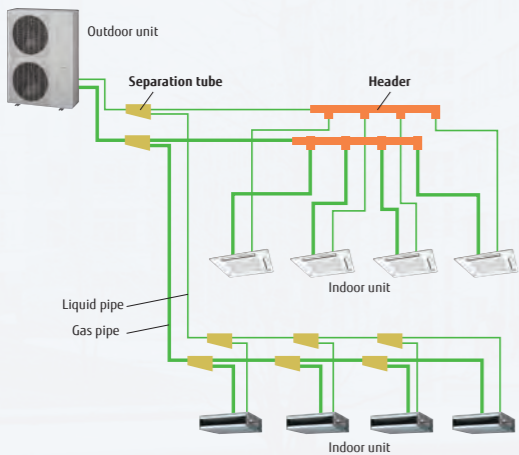

New intelligent refrigerant control

Fujitsu General is proposing outdoor units equipped with refrigerant control function. The refrigerant control operates with suitable control corresponding to the heat load of the room and offers a more comfortable environment. The refrigerant control can also provide increased energy savings.

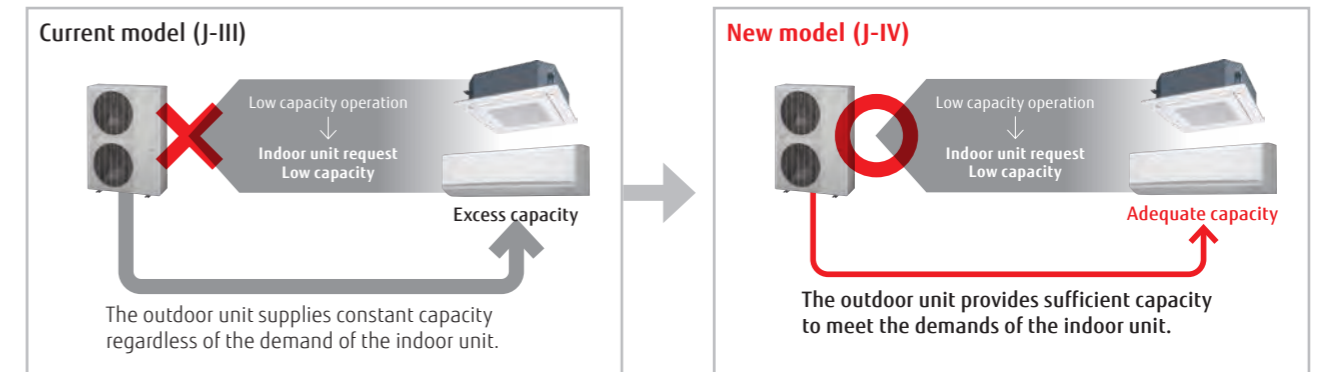

* The improvements due to the control and the actual sine wave vary depending on the combination of the indoor unit and system operating conditions.

External static pressure

External static pressure measures up to 30 Pa for 4/5/6 HP.



Advanced high-efficiency technology

Large propeller fan
A large propeller fan with an optimized blade angle achieves both high performance and low noise operation.

DC fan motor
A small, multi-stage DC fan motor contributes to high-efficiency and low noise operation.

Large heat exchanger
The large 3-row heat exchanger substantially improves heat-exchanging performance.

DC twin-rotary compressor
High-efficiency is achieved across compressor loads. Especially good performance is achieved in the low- to medium-load range.

DC inverter control
The active filter module improves efficiency.

Subcooling heat exchanger
The dual-tube heat exchanger improves cooling performance.

High-efficiency compressor motor
Optimized refrigerant flow design
Highly accurate parts

Pressure
effect
Cooling performance improved
Enthalpy

High
Compressor efficiency
DC Twin-Rotary Compressor
Compressor capacity High

Efficiency in actual operating conditions

The use of a large heat exchanger and a high-efficiency Scroll compressor achieves class-leading EER/COP (Max. Heating) in all models.

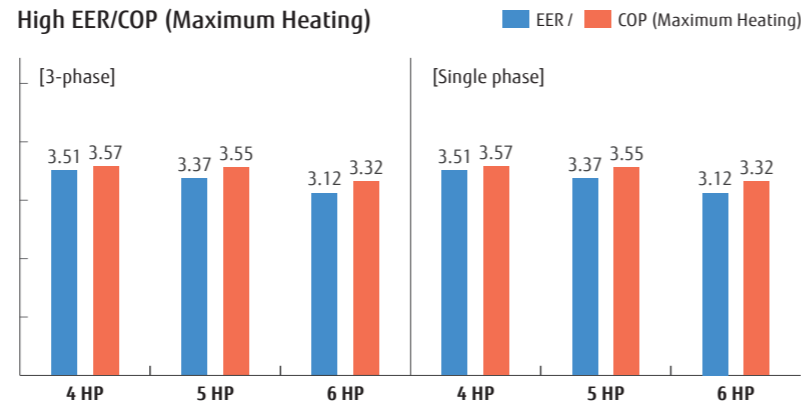

* These specifications are determined by cassette combination.



Long pipe length

Our advanced refrigerant control technology allows us to achieve a total refrigerant pipe length of 180 m. This provides high flexibility in system design.

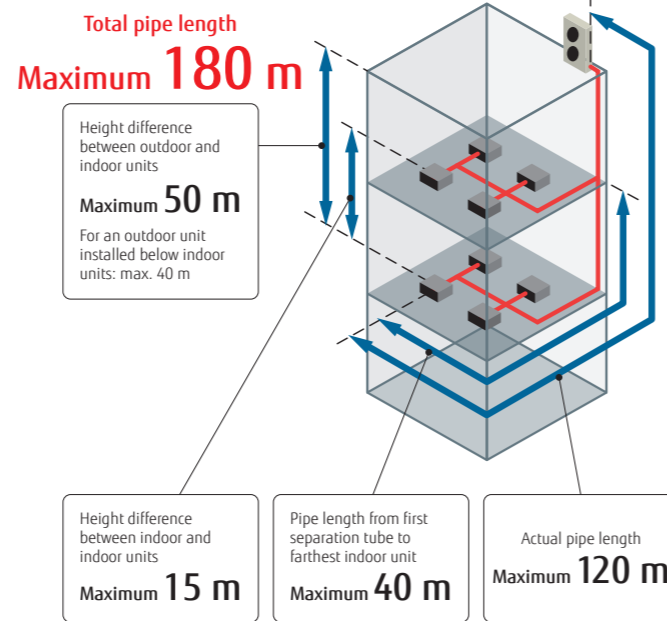

Up to 14 indoor units* can be connected

The combination of smaller but sufficiently powerful indoor units and outdoor units with an optimized heat exchanging structure makes it possible to connect up to 14 indoor units, which is the best in its class.

*: 6 HP model

| Model | Current model (J-III) | | | New model (J-IV) | | |
|------------------------------|-----------------------|------|------|------------------|------|------|
| | 4 | 5 | 6 | 4 | 5 | 6 |
| Rating Capacity range (HP) | 4 | 5 | 6 | 4 | 5 | 6 |
| Max. Connectable indoor unit | 1-9 | 1-10 | 1-13 | 1-11 | 1-12 | 1-14 |

4,5,6HP: AJH040LBDH / AJH045LBDH / AJH054LBDH AJH040LELDH [3-phase] / AJH045LELDH [3-phase] / AJH054LELDH [3-phase]

Specifications

| Rated capacity range | | HP | 4 | 5 | 6 | 4 | 5 | 6 |
|-----------------------------------|---------------------------------|--------------|-----------------------------------|---------------|---------------|-----------------------------------|---------------|---------------|
| Model name | | | AJH040LBDH | AJH045LBDH | AJH054LBDH | AJH040LELDH | AJH045LELDH | AJH054LELDH |
| Maximum connectable indoor units | | | 1-11 | 1-12 | 1-14 | 1-11 | 1-12 | 1-14 |
| Power source | | | Single phase, ~230 V, 50 Hz | | | 3-phase, ~400 V, 50 Hz | | |
| Capacity | Cooling | kW | 12.1 | 14.0 | 15.5 | 12.1 | 14.0 | 15.5 |
| | Nominal Heating | kW | 12.1 | 14.0 | 15.5 | 12.1 | 14.0 | 15.5 |
| | Max. Heating | kW | 13.6 | 16.0 | 18.0 | 13.6 | 16.0 | 18.0 |
| Input power | Cooling | kW | 3.44 | 4.15 | 4.96 | 3.44 | 4.15 | 4.96 |
| | Nominal Heating | kW | 3.14 | 3.60 | 4.17 | 3.14 | 3.60 | 4.17 |
| | Max. Heating | kW | 3.80 | 4.50 | 5.41 | 3.80 | 4.50 | 5.41 |
| EER | Cooling | | 3.51 | 3.37 | 3.12 | 3.51 | 3.37 | 3.12 |
| COP | Nominal Heating | W/W | 3.85 | 3.88 | 3.71 | 3.85 | 3.88 | 3.71 |
| | Max. Heating | W/W | 3.57 | 3.55 | 3.32 | 3.57 | 3.55 | 3.32 |
| | SEER | Cooling | 6.50 | 6.30 | 6.08 | 6.50 | 6.30 | 6.08 |
| SCOP | Heating | | 3.83 | 3.93 | 3.94 | 3.83 | 3.93 | 3.94 |
| ηc | Cooling | % | 257.0 | 249.0 | 240.0 | 257.0 | 249.0 | 240.0 |
| ηh | Heating | % | 150.0 | 154.0 | 155.0 | 150.0 | 154.0 | 155.0 |
| Airflow rate | | m³/h | 6,200 | 6,600 | 7,000 | 6,200 | 6,600 | 7,000 |
| Sound pressure level/ Power level | Cooling | dB(A) | 50 / 65 | 52 / 66 | 53 / 67 | 50 / 65 | 52 / 66 | 53 / 67 |
| | Heating | dB(A) | 52 / 67 | 55 / 69 | 56 / 69 | 52 / 67 | 55 / 69 | 56 / 69 |
| Heat exchanger fin | | | Blue fin | Blue fin | Blue fin | Blue fin | Blue fin | Blue fin |
| Net Dimensions | Height | mm | 1,334 | 1,334 | 1,334 | 1,334 | 1,334 | 1,334 |
| | Width | mm | 970 | 970 | 970 | 970 | 970 | 970 |
| | Depth | mm | 370 | 370 | 370 | 370 | 370 | 370 |
| Weight | | kg | 117 | 117 | 119 | 118 | 119 | 119 |
| Refrigerant | Type (Global Warming Potential) | | R410A (2,088) | R410A (2,088) | R410A (2,088) | R410A (2,088) | R410A (2,088) | R410A (2,088) |
| | Charge | kg (CO2eq-T) | 4.8 (10.0) | 5.3 (11.1) | 5.3 (11.1) | 4.8 (10.0) | 5.3 (11.1) | 5.3 (11.1) |
| Connection pipe diameter | Liquid | mm | 9.52 | 9.52 | 9.52 | 9.52 | 9.52 | 9.52 |
| | Gas | mm | 15.88 | 15.88 | 19.05 | 15.88 | 15.88 | 19.05 |
| Total pipe length | | m | 180 | 180 | 180 | 180 | 180 | 180 |
| Max. height difference | | m | 50/40 (Outdoor unit: Upper/Lower) | | | 50/40 (Outdoor unit: Upper/Lower) | | |
| Operating Range | Cooling | °C | -5 to 46 | -5 to 46 | -5 to 46 | -5 to 46 | -5 to 46 | -5 to 46 |
| | Heating | °C | -20 to 21 | -20 to 21 | -20 to 21 | -20 to 21 | -20 to 21 | -20 to 21 |

Note: Specifications are based on the following conditions.
Cooling: Indoor temperature of 27°CDB/19°CWB, and outdoor temperature of 35°CDB/24°CWB.
Heating: Indoor temperature of 20°CDB/15°CWB, and outdoor temperature of 7°CDB/6°CWB.
Pipe length: 7.5 m; Height difference between outdoor unit and indoor unit: 0 m.
The protective function may work when using it outside the operation range.

Dimensions

(Unit: mm)

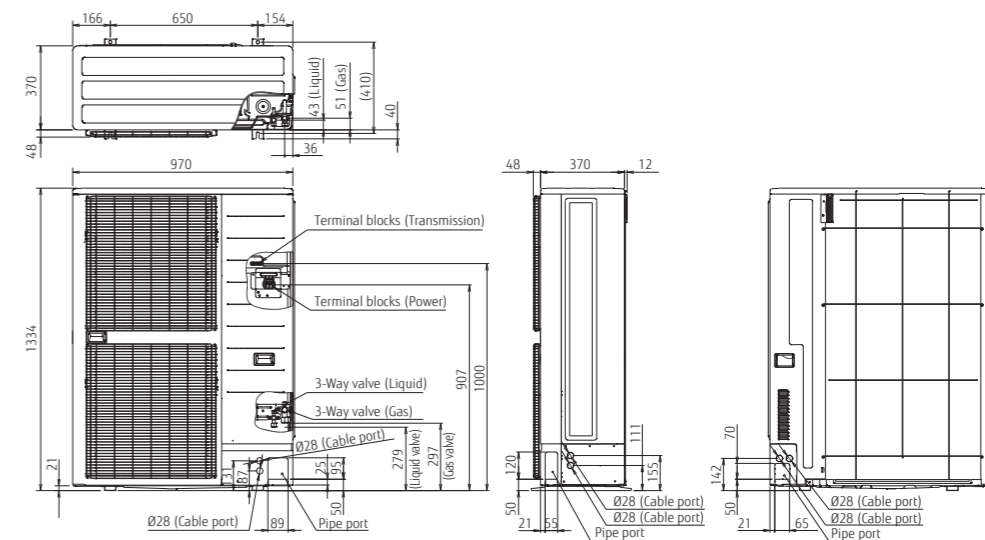

Non-stop oil recovery operation

A comfortable room condition is maintained during oil recovery mode because the product continues to operate without stopping the cooling or heating operation.

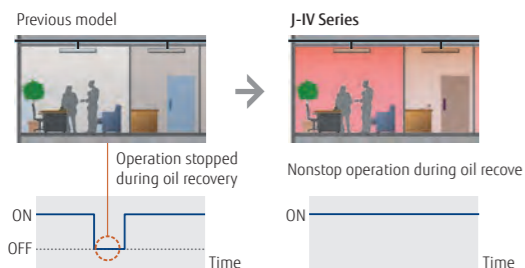

Easier installation

Connection check function: Wiring connections and address settings can be checked thanks to the quick check run function.

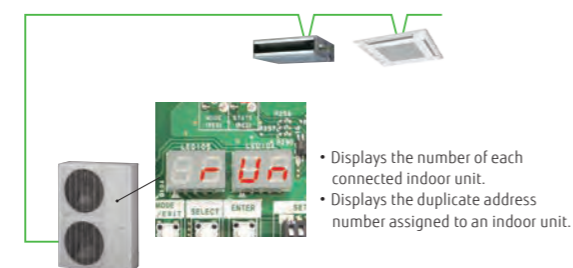

Heat Pump

for Small-capacity type

VRF J-IVS

System configuration example

- Suitable for air conditioning small and medium-size buildings. One refrigerant system is used for each outdoor unit.
- Multiple indoor units are connected with separation tubes and headers.

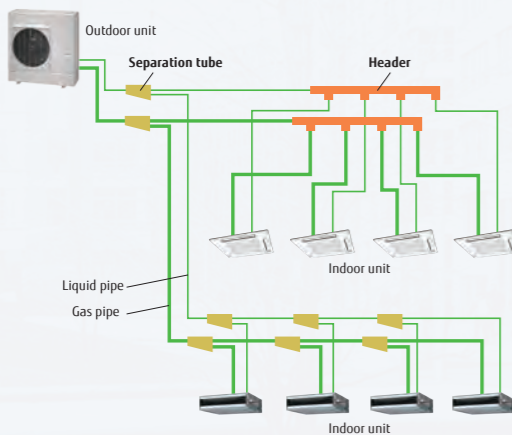

New intelligent refrigerant control

Fujitsu General is proposing outdoor units equipped with refrigerant control function. The refrigerant control operates with suitable control corresponding to the heat load of the room and offers a more comfortable environment. The refrigerant control can also provide increased energy savings.

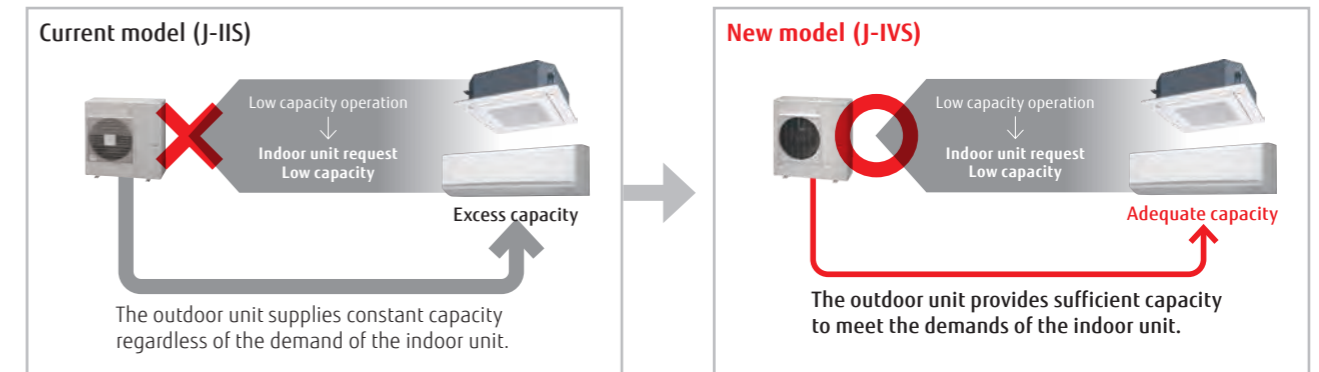

* The improvements due to the control and the actual sine wave vary depending on the combination of the indoor unit and system operating conditions.

External static pressure

External static pressure measures up to 25 Pa for 4/5/6 HP models.



Advanced high-efficiency technology

- Large propeller fan**: A large propeller fan with an optimized blade angle achieves both high performance and low noise operation.
- DC fan motor**: A small, multi-stage DC fan motor provides high-efficiency and low noise operation.
- Large heat exchanger**: The large 3-row heat exchanger substantially improves heat-exchanging performance.
 - High heat-transfer copper tube (Improved lead angle)
- DC inverter control**: The active filter module improves efficiency.
- Compact and high-performance DC twin-rotary compressor**: High-efficiency is achieved across compressor loads. Especially good performance is achieved in the low- to medium-load range.
 - Low noise rubber
 - High-efficiency compressor motor
 - Optimized refrigerant flow design
 - Highly accurate parts

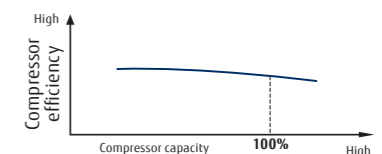

Easy to carry, easy to install

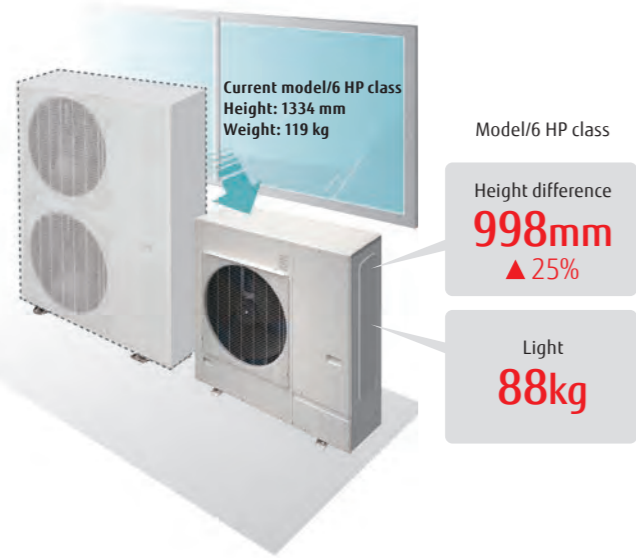

Small, lightweight outdoor unit

The outdoor units in this series are much more compact than conventional outdoor units of comparable capacity. They can be installed on a balcony, fitting below the height of the railing. With a height of less than 1 m, they can be installed in tight spaces such as under windows.



Low noise design

Significantly low noise levels are achieved by the use of a DC twin-rotary compressor, inverter technology, and an advanced airflow pattern design.



Long pipe length

Our advanced refrigerant control technology extends the maximum allowable length of refrigerant piping to 80 m. This provides high flexibility in system design.

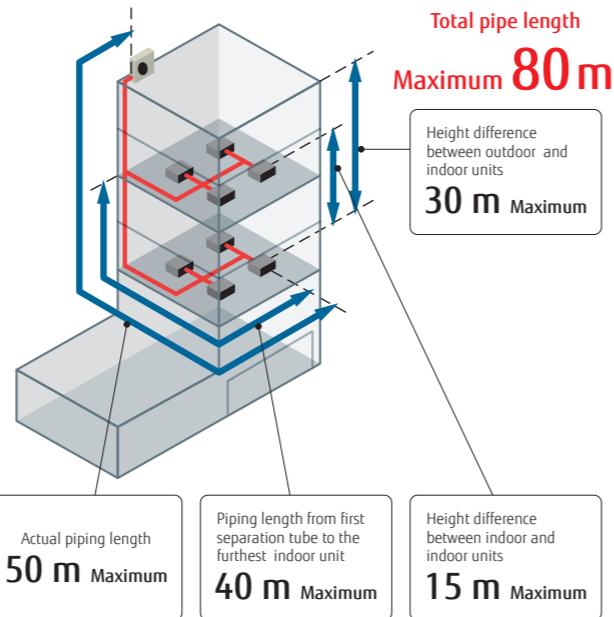

Up to 13 indoor units* can be connected

The combination of smaller but sufficiently powerful indoor units and a new outdoor unit with an optimized heat exchanging structure makes it possible to connect up to 13 indoor units, which is the best in its class.

*: 6 HP model

| Model | Current model (J-IVS) | | | New model (J-IVS) | | |
|------------------------------|-----------------------|-----|-----|-------------------|------|------|
| | 4 | 5 | 6 | 4 | 5 | 6 |
| Rating Capacity range (HP) | 4 | 5 | 6 | 4 | 5 | 6 |
| Max. Connectable indoor unit | 1-7 | 1-8 | 1-8 | 1-11 | 1-12 | 1-13 |

Non-stop oil recovery operation

A comfortable room condition is maintained during oil recovery mode because the product continues to operate without stopping the cooling or heating operation.

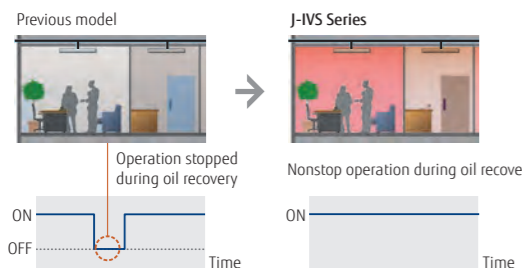

Easier installation

Connection check function: Wiring connections and address settings can be checked thanks to the quick check run function.

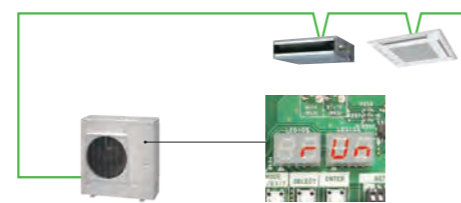

- Displays the number of each connected indoor unit.
- Displays the duplicate address number assigned to an indoor unit.

Specifications

| Rated capacity range | | HP | 4 | 5 | 6 |
|----------------------------------|-----------------|---------------------------|---------------------------------|---------------|---------------|
| Model name | | | AJH040LCLDH | AJH045LCLDH | AJH054LCLDH |
| Maximum connectable indoor units | | | 1-11 | 1-12 | 1-13 |
| Power source | | | Single phase, ~230 V, 50 Hz | | |
| Capacity | Cooling | kW | 12.1 | 14.0 | 15.1 |
| | Nominal Heating | | 12.1 | 14.0 | 15.1 |
| | Max. Heating | | 13.6 | 16.0 | 16.5 |
| Input power | Cooling | kW | 3.75 | 4.71 | 5.55 |
| | Nominal Heating | | 3.22 | 3.77 | 4.33 |
| | Max. Heating | | 3.99 | 5.04 | 5.32 |
| EER | Cooling | | 3.22 | 2.97 | 2.72 |
| COP | Nominal Heating | W/W | 3.75 | 3.71 | 3.48 |
| | Max. Heating | | 3.40 | 3.17 | 3.10 |
| SEER | Cooling | | 5.83 | 5.58 | 5.47 |
| SCOP | Heating | | 3.82 | 3.96 | 3.99 |
| ηc | Cooling | % | 230.2 | 220.2 | 215.8 |
| ηh | Heating | | 149.8 | 155.4 | 156.6 |
| Airflow rate | | m ³ /h | 4,240 | 4,400 | 4,400 |
| Sound pressure level/Power level | Cooling | dB(A) | 53 / 67 | 53 / 69 | 54 / 70 |
| | Heating | | 54 / 68 | 56 / 69 | 56 / 70 |
| Heat exchanger fin | | | Blue fin | | |
| Net Dimensions | Height | mm | 998 | 998 | 998 |
| | Width | | 970 | 970 | 970 |
| | Depth | | 370 | 370 | 370 |
| Weight | | kg | 88 | 88 | 88 |
| | Refrigerant | | Type (Global Warming Potential) | R410A (2,088) | R410A (2,088) |
| Connection pipe diameter | Charge | kg (CO ₂ eq-T) | 4.0 (8.4) | 4.0 (8.4) | 4.0 (8.4) |
| | Liquid | mm | 9.52 | 9.52 | 9.52 |
| Total pipe length | Gas | | 15.88 | 15.88 | 15.88 |
| | | m | 80 | 80 | 80 |
| Max. height difference | | | 30 | 30 | 30 |
| | | °C | -5 to 46 | -5 to 46 | -5 to 46 |
| Operating Range | Cooling | | -20 to 21 | -20 to 21 | -20 to 21 |
| | Heating | | -20 to 21 | -20 to 21 | -20 to 21 |

Note: Specifications are based on the following conditions.

Cooling: Indoor temperature of 27°CDB/19°CWB, and outdoor temperature of 35°CDB/24°CWB.
Heating: Indoor temperature of 20°CDB/15°CWB, and outdoor temperature of 7°CDB/6°CWB.
Pipe length: 7.5 m; Height difference between outdoor unit and indoor unit: 0 m.
The protective function may work when using it outside the operation range.

Dimensions

(Unit: mm)

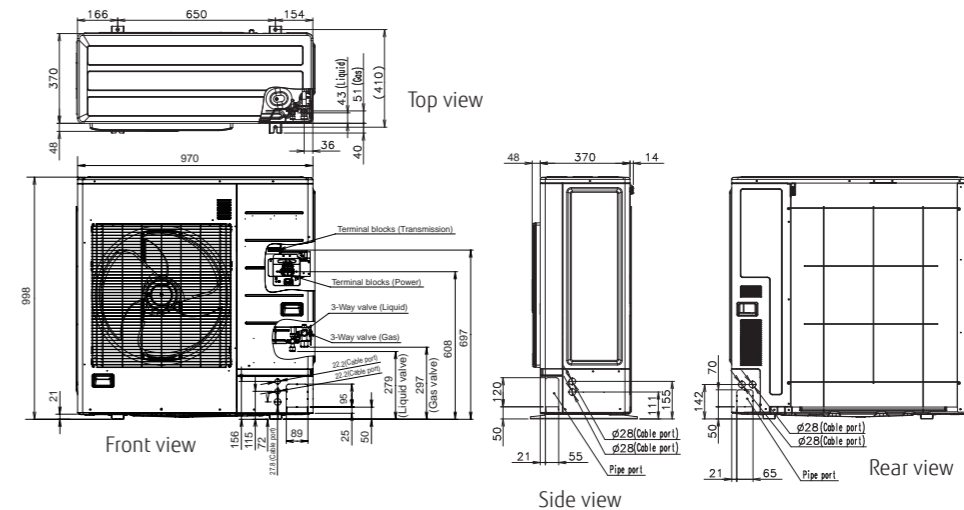

Heat Recovery

Modular Type

VRF VR-IV

Highly energy-efficient operation

Our heat recovery systems achieve high operating energy efficiency by drawing heat from the room to be cooled and transferring it as energy for rooms that are to be heated.

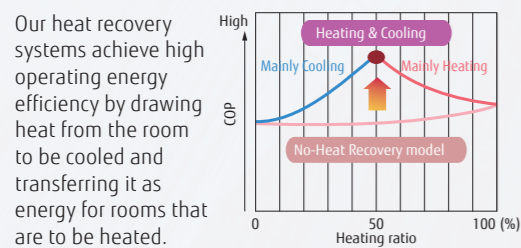
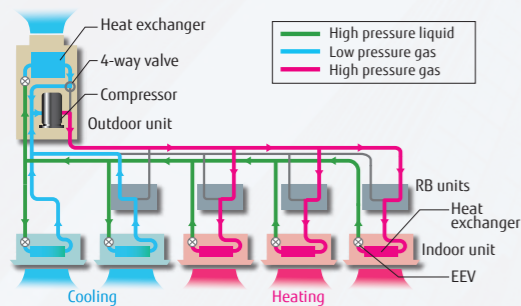

New intelligent refrigerant control

Fujitsu General is proposing outdoor units equipped with refrigerant control function. The refrigerant control operates with suitable control corresponding to the heat load of the room and offers a more comfortable environment. The refrigerant control can also provide increased energy savings.

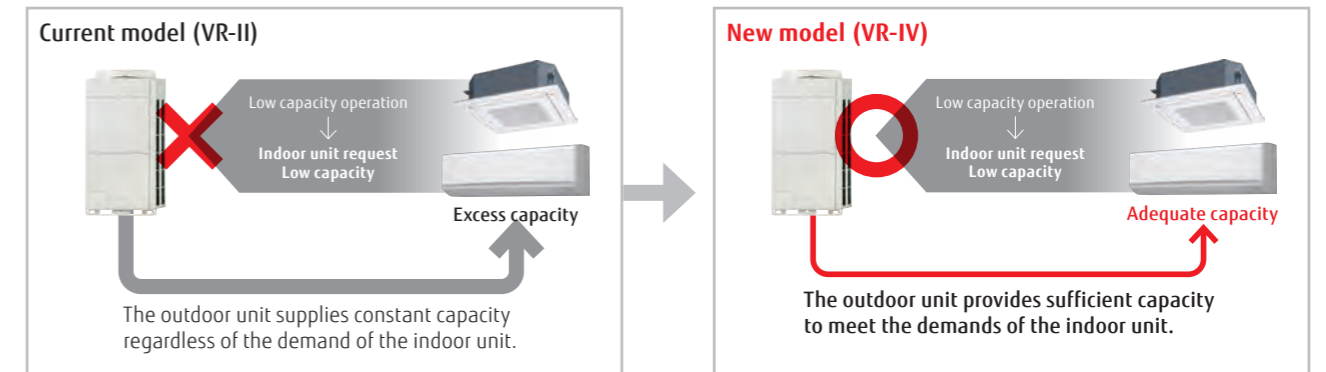

* The improvements due to the control and the actual sine wave vary depending on the combination of the indoor unit and system operating conditions.

Increase in the number of connectable indoor units

Capacity range of connectable indoor units

| | |
|-----------------------|--------------|
| New model (VR-IV) | 25%* to 150% |
| Current model (VR-II) | 50% to 150% |

*: For modular type, 25% to 49.9% operation in the entire system is available. (by one unit operation)

Increased number of connectable indoor units and space saving combinations

| HP | 10 | 12 | 14 | 16 | ... | 28 | 30 | 32 | ... | 48 | |
|-----------------------|----|----|----|----|-----|-----|----|----|-----|-----|----|
| New model (VR-IV) | 21 | 26 | 30 | 34 | ... | 60 | 64 | 64 | ... | 64 | |
| Current model (VR-II) | 15 | 16 | 17 | 21 | 24 | ... | 42 | 45 | 48 | ... | 64 |

The energy-saving technology that boosted operation efficiency

- Powerful large propeller fan**
The fan uses CFD* technology to achieve both high performance and low noise operation.
*CFD: Computational Fluid Dynamics
- 3-phase DC fan motor**
The use of a DC fan motor with sophisticated driver control improves energy efficiency substantially. In addition, this motor operates quietly.
- Subcooling heat exchanger**
High heat exchange efficiency is achieved by using an internal projection-shape double-pipe construction.
- High-efficient, large-capacity DC twin-rotary compressor**
Large-capacity high-efficient DC twin-rotary compressor with excellent intermediate capability.
- Sine-wave DC inverter control**
High-efficiency is realized by the adoption of reduced switching loss IPM.
- 4-face heat exchanger**
The 4-face heat exchanger increases the effective surface area and significantly improves heat-exchanging efficiency.
- Front intake port (Corner cut air inlet structure)**
In multiple outdoor unit installations, the unique front intake design improves airflow into the heat exchanger.

Extended connection ratio (applicable to multiple tenants)

Especially useful when starting partial air conditioning in a building under construction
Installation can be added flexibly for each tenant.



Stand-alone

Current model (VR-II)

Example) 50% of 12HP minimum connected indoor unit capacity is required

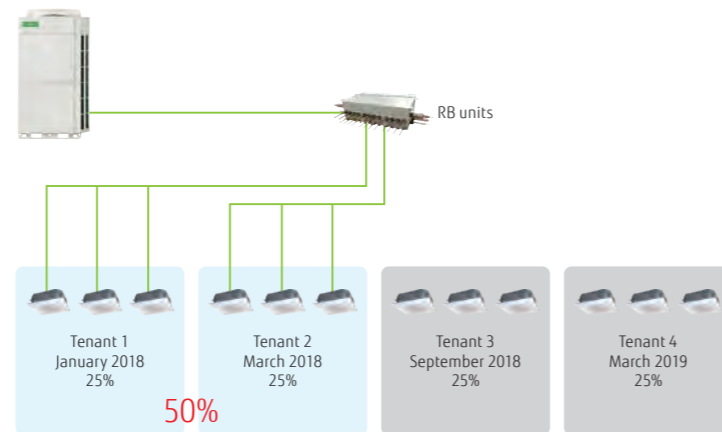

Installation is possible even for tenants who have not yet started operations.

New model (VR-IV)

Example) 25% of 12HP minimum connected indoor unit capacity is required

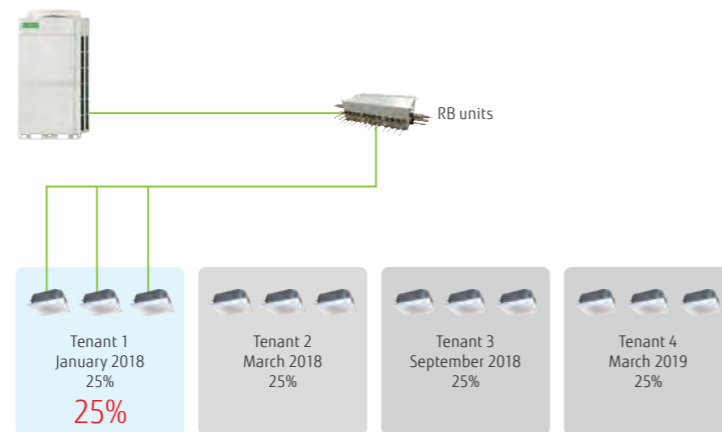

Installation and commissioning can be added flexibly to meet the opening dates of other tenants.

Modular type

One outdoor unit operates effectively for the capacities of connectable indoor units in the entire system. (Each of the multiple outdoor units does not dare operate at 25% capacity: any one of the outdoor units will operate at 50% and the remaining units will each output 0%, i.e., stop operating.)

Example: One 10HP outdoor unit performs 25% of the total 20HP outdoor units system.
One 10HP outdoor unit performs 50% of its capacity
→ Two outdoor units do not perform 25% of the operation.



Additional installation is possible without changing the main pipe.

A main pipe of a diameter that can be used for the final system is installed at the beginning of the installation.
Duplication of the work will be avoided as there is no need to change the main pipe as in the previous model.

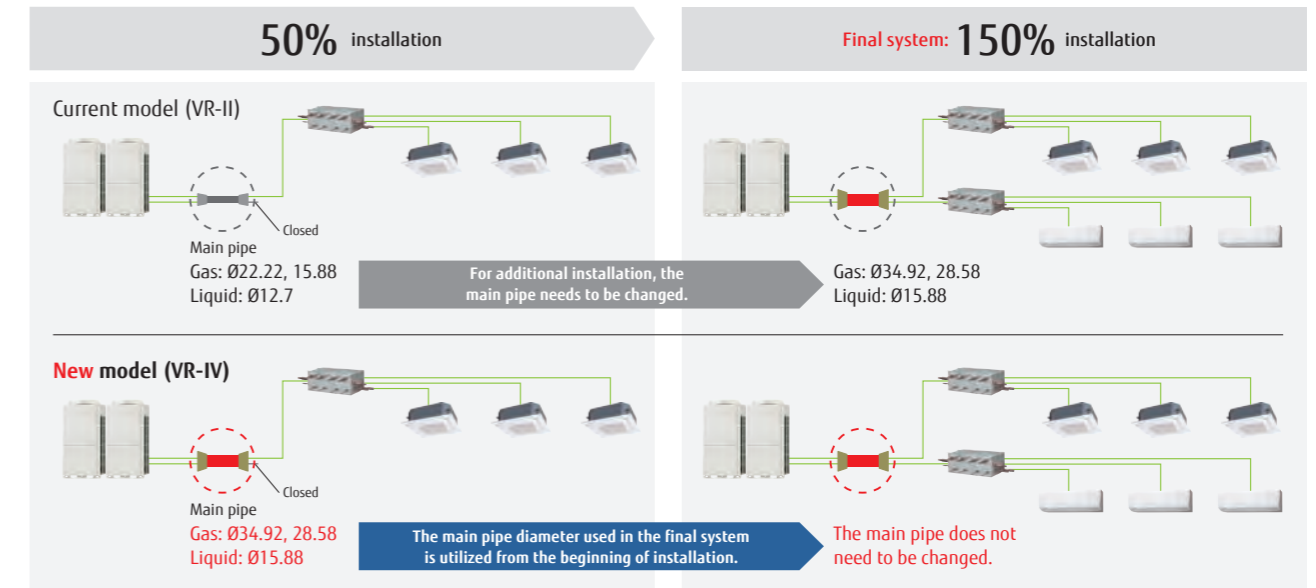

All-inverter compressor

Large-capacity DC inverter compressor

Large-capacity high-efficient DC twin-rotary compressor with excellent intermediate capability.



High-efficiency compressor speed control

The compressor speed control in 0.1 Hz increments ensures a comfortable space with less change in room temperature and less energy loss.

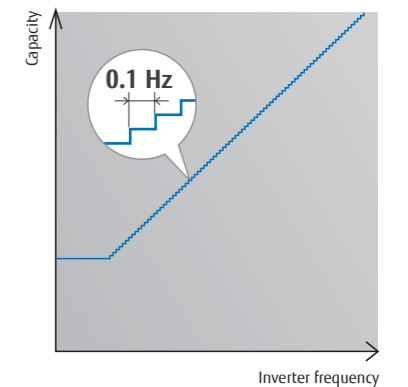

Efficiency in actual operating conditions

Class-leading high COP (Maximum) The use of our proprietary heat exchanger structure and high-efficiency DC twin-rotary compressors achieves the class-leading coefficient of performance (COP) in every combination.

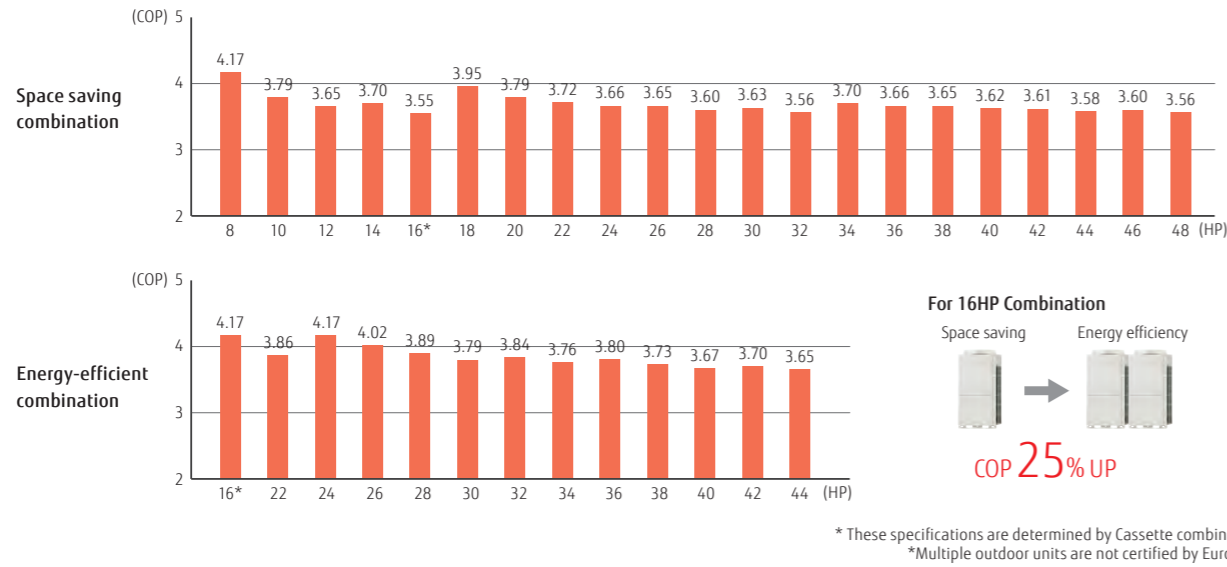

Multiple outdoor operation control

When multiple outdoor units are connected, each compressor carries out sophisticated operation. Instead of operating one compressor at full load to distribute the refrigerant to one heat exchanger, all compressors operate at partial load to distribute the refrigerant to all heat exchangers, thereby improving the efficiency of the entire system.

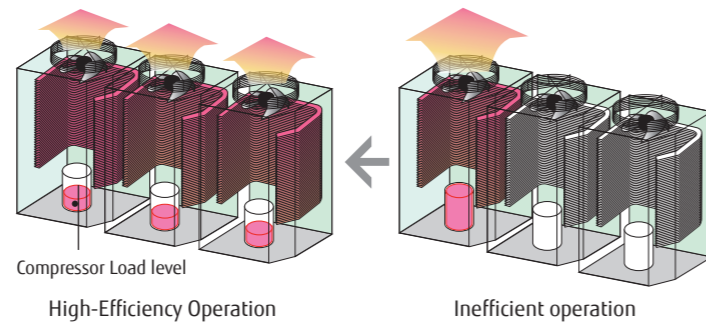

Heat exchanger refrigerant control

The heat exchanger in the outdoor unit is divided into two parts, upper and lower. The efficiency of the heat exchanger has been improved by adopting an optimum refrigerant path control where the refrigerant is distributed more into the top heat exchanger as this is where there is a greater air flow intake.

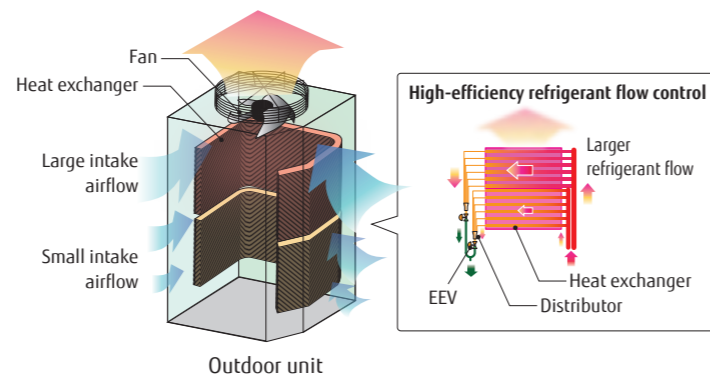

Flexible pipe connection

More flexible refrigerant pipe work is possible due to the use of various piping and RB unit connections, for adjustments to the floor layout and building structure.

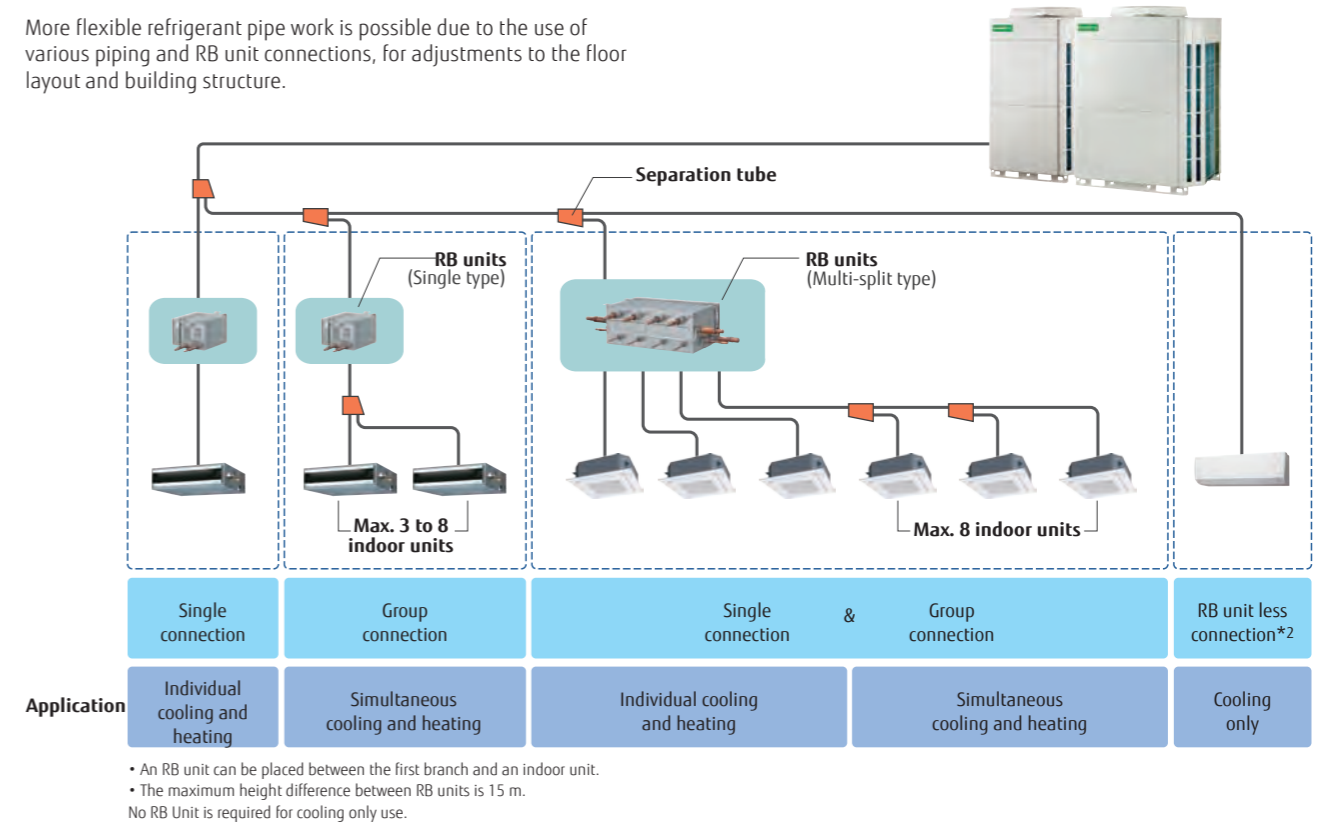

Flexible installation of RB unit

Small and slim design with a height of 198 mm makes it easy to install in tight spaces with height constraints.

- A drain pipe is not required.
- Different positions of a control box can be chosen to accommodate installation conditions.
- Series connection for simplified installation

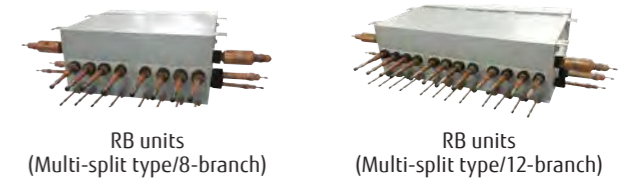
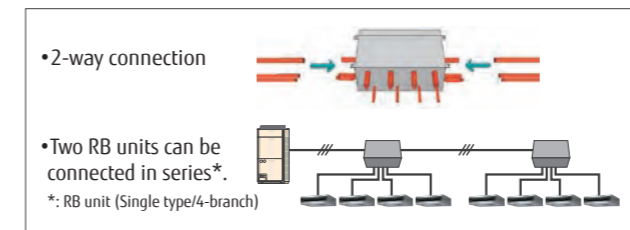

Easy maintenance in tight spaces

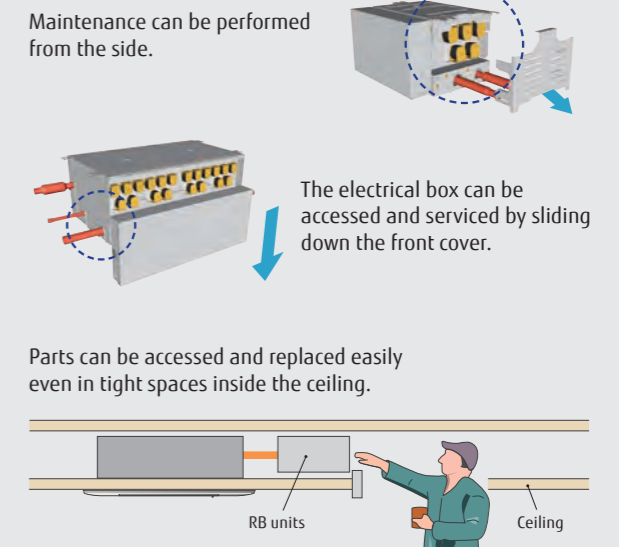

Outdoor units lineup • Combinations other than those listed below are not recommended.

Space saving combination

| | | | | |
|---|---|---|---|---|
| 22.4kW (8HP) AJH072GALDH UNIT : AJH072GALDH | 28.0kW (10HP) AJH090GALDH UNIT : AJH090GALDH | 33.5kW (12HP) AJH108GALDH UNIT : AJH108GALDH | 40.0kW (14HP) AJH126GALDH UNIT : AJH126GALDH | 45.0kW (16HP) AJH144GALDH UNIT : AJH144GALDH |
| 50.4kW (18HP) AJH162GALDH UNIT : AJH090/072GALDH | 56.0kW (20HP) AJH180GALDH UNIT : AJH090/090GALDH | 61.5kW (22HP) AJH198GALDH UNIT : AJH108/090GALDH | 67.0kW (24HP) AJH216GALDH UNIT : AJH108/108GALDH | 73.0kW (26HP) AJH234GALDH UNIT : AJH144/090GALDH |
| 78.5kW (28HP) AJH252GALDH UNIT : AJH144/108GALDH | 85.0kW (30HP) AJH270GALDH UNIT : AJH144/126GALDH | 90.0kW (32HP) AJH288GALDH UNIT : AJH144/144GALDH | 95.0kW (34HP) AJH306GALDH UNIT : AJH108/108/090GALDH | 100.5kW (36HP) AJH324GALDH UNIT : AJH108/108/108GALDH |
| 106.5kW (38HP) AJH342GALDH UNIT : AJH144/108/090GALDH | 112.0kW (40HP) AJH360GALDH UNIT : AJH144/108/108GALDH | 118.0kW (42HP) AJH378GALDH UNIT : AJH144/144/090GALDH | 123.5kW (44HP) AJH396GALDH UNIT : AJH144/144/108GALDH | 130.0kW (46HP) AJH414GALDH UNIT : AJH144/144/126GALDH |
| 135.0kW (48HP) AJH432GALDH UNIT : AJH144/144/144GALDH | | | | |

Energy efficiency combination

| | | | | |
|--|--|--|--|--|
| 44.8kW (16HP) AJH144GALDHH UNIT : AJH072/072GALDH | 62.4kW (22HP) AJH198GALDHH UNIT : AJH126/072GALDH | 67.2kW (24HP) AJH216GALDHH UNIT : AJH072/072/072GALDH | 72.8kW (26HP) AJH234GALDHH UNIT : AJH090/072/072GALDH | 78.4kW (28HP) AJH252GALDHH UNIT : AJH090/090/072GALDH |
| 84.0kW (30HP) AJH270GALDHH UNIT : AJH090/090/090GALDH | 90.4kW (32HP) AJH288GALDHH UNIT : AJH126/090/072GALDH | 96.0kW (34HP) AJH306GALDHH UNIT : AJH126/090/090GALDH | 102.4kW (36HP) AJH324GALDHH UNIT : AJH126/126/072GALDH | 108.0kW (38HP) AJH342GALDHH UNIT : AJH126/126/090GALDH |
| 113.0kW (40HP) AJH360GALDHH UNIT : AJH144/126/090GALDH | 120.0kW (42HP) AJH378GALDHH UNIT : AJH126/126/126GALDH | 125.0kW (44HP) AJH396GALDHH UNIT : AJH144/126/126GALDH | | |

8,10,12HP : AJH072GALDH / AJH090GALDH / AJH108GALDH
14,16HP : AJH126GALDH / AJH144GALDH



Dimensions

(Unit: mm)

8, 10, 12 HP

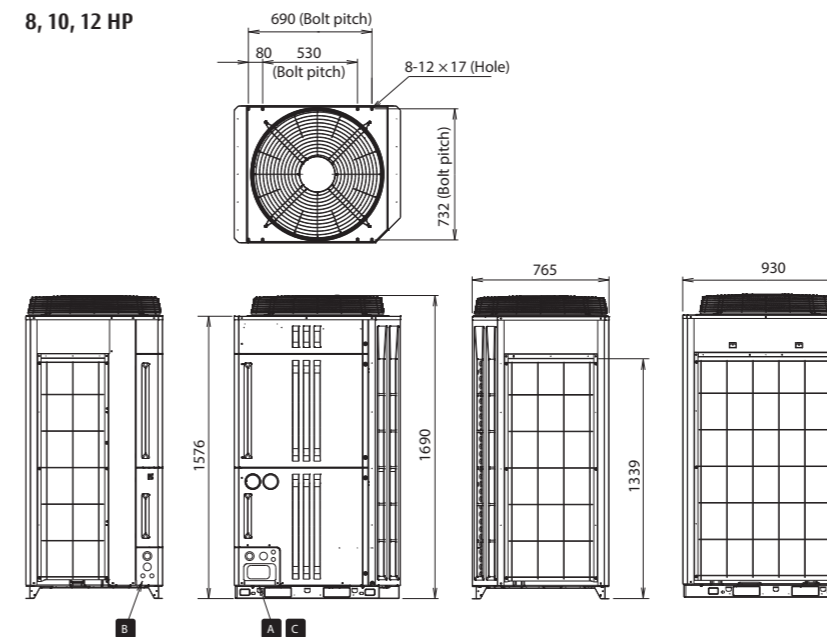

14, 16 HP

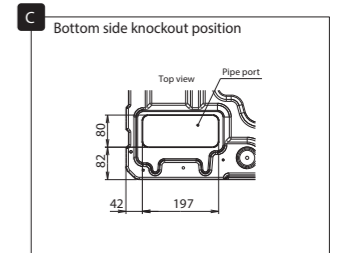
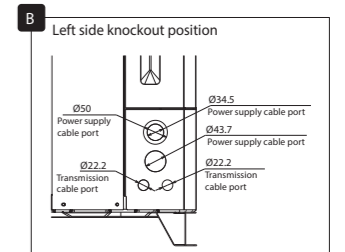
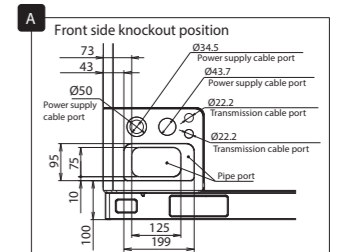
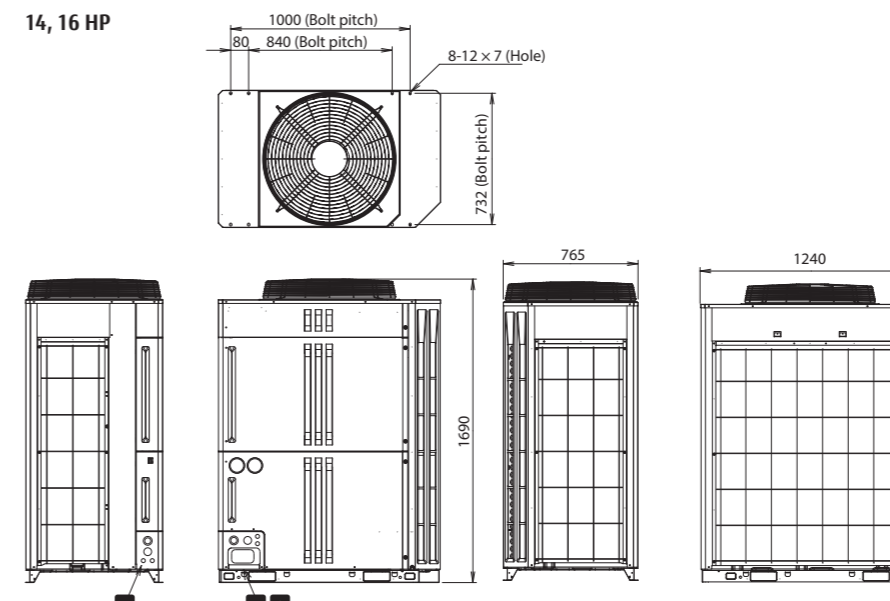

Heat Pump

Modular Type

VRF V-IV

System configuration example

- Suitable for air conditioning midsize and large buildings. Connecting each outdoor unit makes it possible to create a high-capacity system.
- Multiple indoor units are connected with separation tubes and headers.

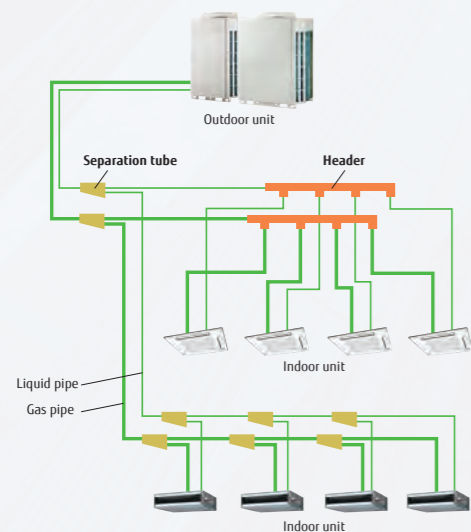

New intelligent refrigerant control

Fujitsu General is proposing outdoor units equipped with refrigerant control function. The refrigerant control operates with subtle control corresponding to the heat load of the room and offers a more comfortable environment. The refrigerant control can also provide increased energy savings.

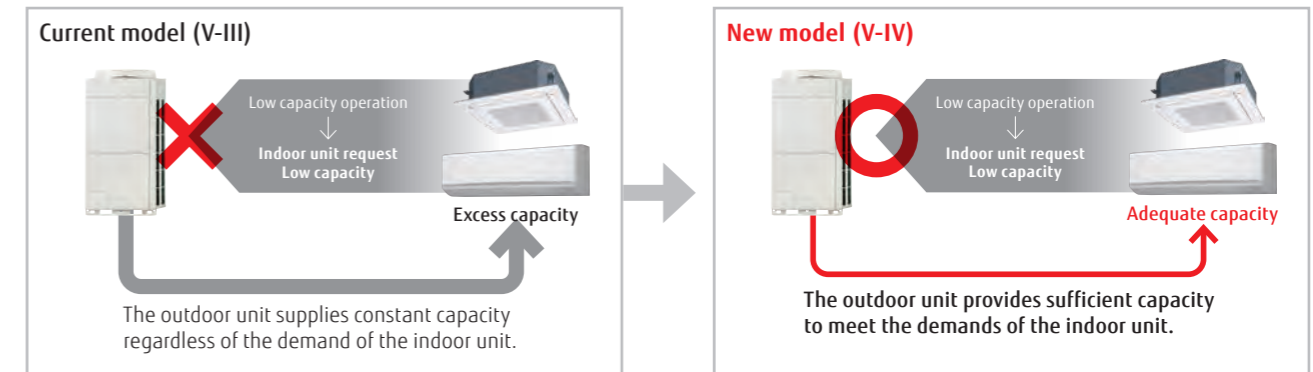

* The improvements due to the control and the actual sine wave vary depending on the combination of the indoor unit and system operating conditions.

Efficiency in actual operating conditions

The use of our proprietary heat exchanger structure and high-efficiency DC twin-rotary compressors achieves the class-leading coefficient of performance (COP) in every combination.

Space saving combination

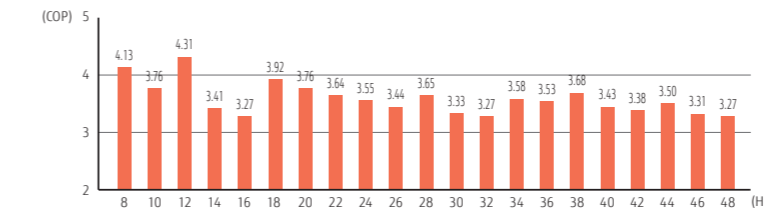

Energy efficiency combination

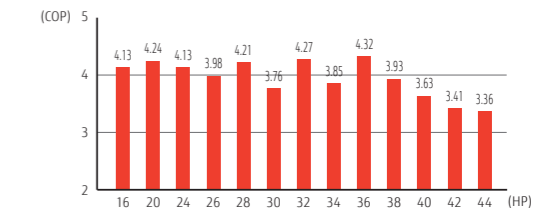

* These specifications are determined by Cassette combination. *Multiple outdoor units are not certified by Eurovent.

The energy-saving technology that boosted operation efficiency



- Powerful large propeller fan**
The fan uses CFD* technology to achieve both high performance and low noise operation. *CFD: Computational Fluid Dynamics
- 3-phase DC fan motor**
The use of a DC fan motor with sophisticated driver control improves energy efficiency substantially. In addition, low noise is realized by the DC fan motor.
- Sine-wave DC inverter control**
High-efficiency is realized by the adoption of reduced switching loss IPM.
- 4-face heat exchanger**
The 4-face heat exchanger increases the effective surface area and significantly improves heat-exchanging efficiency.
- Subcooling heat exchanger**
High heat exchange efficiency is achieved by using an internal projection-shape double-pipe construction.
- High-efficient, large-capacity DC twin-rotary compressor**
Large-capacity high-efficient DC twin-rotary compressor with excellent intermediate capability.
- Front intake port (Corner cut air inlet structure)**
In multiple outdoor unit installations, the unique front intake design improves airflow into the heat exchanger.

Outdoor units lineup• Combinations other than those listed below are not recommended.

Space saving combination

| | | | | |
|--|--|--|--|--|
| 22.4 kW (8 HP) AJH072LALDH UNIT: AJH072LALDH | 28.0 kW (10 HP) AJH090LALDH UNIT: AJH090LALDH | 33.5 kW (12 HP) AJH108LALDH UNIT: AJH108LALDH | 40.0 kW (14 HP) AJH126LALDH UNIT: AJH126LALDH | 45.0 kW (16 HP) AJH144LALDH UNIT: AJH144LALDH |
| 50.4 kW (18 HP) AJH162LALDH UNIT: AJH090/072LALDH | 56.0 kW (20 HP) AJH180LALDH UNIT: AJH090/090LALDH | 62.4 kW (22 HP) AJH198LALDH UNIT: AJH126/072LALDH | 68.0 kW (24 HP) AJH216LALDH UNIT: AJH126/090LALDH | 73.0 kW (26 HP) AJH234LALDH UNIT: AJH144/090LALDH |
| 78.5 kW (28 HP) AJH252LALDH UNIT: AJH144/108LALDH | 85.0 kW (30 HP) AJH270LALDH UNIT: AJH144/126LALDH | 90.0 kW (32 HP) AJH288LALDH UNIT: AJH144/144LALDH | 95.4 kW (34 HP) AJH306LALDH UNIT: AJH144/090/072LALDH | 101.0 kW (36 HP) AJH324LALDH UNIT: AJH144/090/090LALDH |
| 106.5 kW (38 HP) AJH342LALDH UNIT: AJH144/108/090LALDH | 113.0 kW (40 HP) AJH360LALDH UNIT: AJH144/126/090LALDH | 118.0 kW (42 HP) AJH378LALDH UNIT: AJH144/144/090LALDH | 123.5 kW (44 HP) AJH396LALDH UNIT: AJH144/144/108LALDH | 130.0 kW (46 HP) AJH414LALDH UNIT: AJH144/144/126LALDH |
| 135.0 kW (48 HP) AJH432LALDH UNIT: AJH144/144/144LALDH | | | | |

Energy efficiency combination

| | | | | |
|---|---|---|---|---|
| 44.8 kW (16 HP) AJH144LALDHH UNIT: AJH072/072LALDH | 55.9 kW (20 HP) AJH180LALDHH UNIT: AJH108/072LALDH | 67.2 kW (24 HP) AJH216LALDHH UNIT: AJH072/072/072LALDH | 72.8 kW (26 HP) AJH234LALDHH UNIT: AJH090/072/072LALDH | 78.3 kW (28 HP) AJH252LALDHH UNIT: AJH108/072/072LALDH |
| 84.8 kW (30 HP) AJH270LALDHH UNIT: AJH126/072/072LALDH | 89.4 kW (32 HP) AJH288LALDHH UNIT: AJH108/108/072LALDH | 95.9 kW (34 HP) AJH306LALDHH UNIT: AJH126/108/072LALDH | 100.5 kW (36 HP) AJH324LALDHH UNIT: AJH108/108/108LALDH | 107.0 kW (38 HP) AJH342LALDHH UNIT: AJH126/108/108LALDH |
| 113.5 kW (40 HP) AJH360LALDHH UNIT: AJH126/126/108LALDH | 120.0 kW (42 HP) AJH378LALDHH UNIT: AJH126/126/126LALDH | 125.0 kW (44 HP) AJH396LALDHH UNIT: AJH144/126/126LALDH | | |

8, 10 HP: AJH072LALDH / AJH090LALDH
12, 14, 16 HP: AJH108LALDH / AJH126LALDH / AJH144LALDH



8, 10 HP

12, 14, 16 HP

Dimensions

(Unit: mm)

8, 10 HP

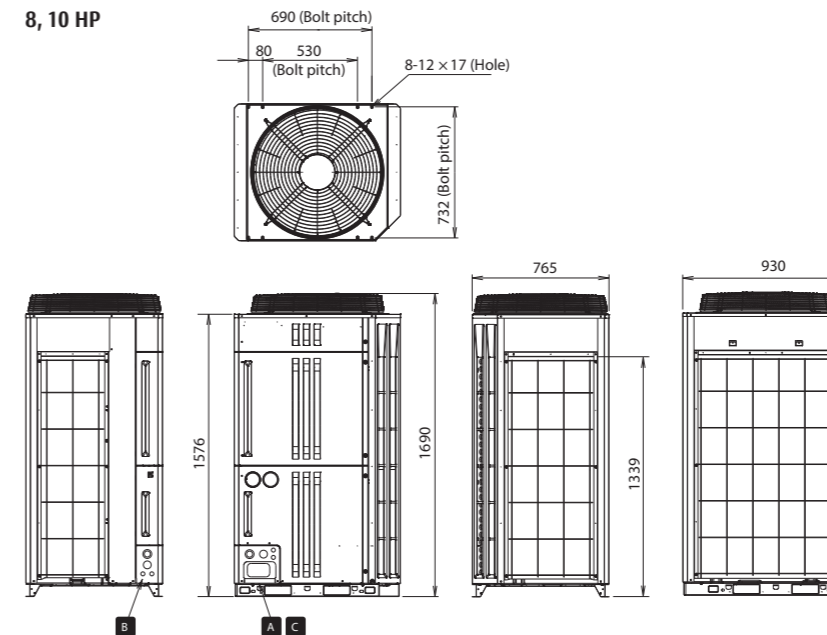

12, 14, 16 HP

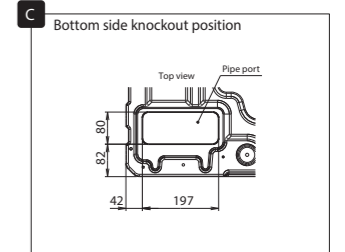
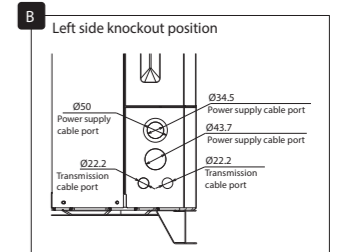
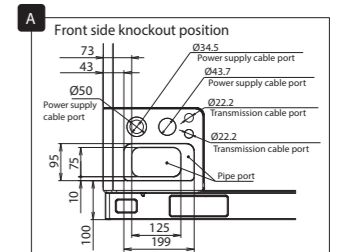
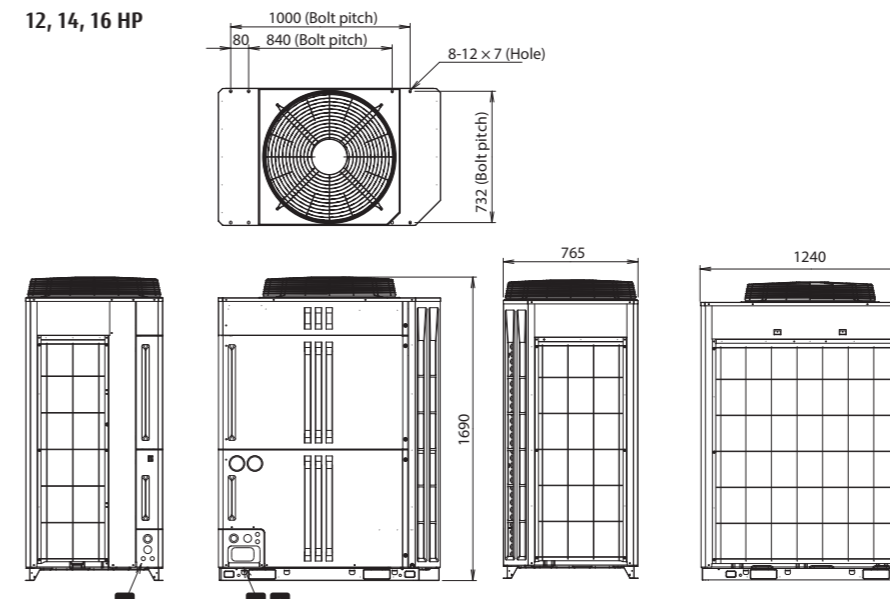

Outdoor unit specifications

Space saving combination

| Rated capacity range | HP | 8 | 10 | 12 | 14 | 16 | 18 | 20 | 22 | 24 | 26 | 28 | 30 | 32 | 34 | 36 | 38 | 40 | 42 | 44 | 46 | 48 | |
|--|---------------------------------|---|---|---|---|---|---|---|---|---|---|---|---|---|---|---|---|---|---|---|---|---|--|
| Model name | | AJH072LALDH | AJH090LALDH | AJH108LALDH | AJH126LALDH | AJH144LALDH | AJH162LALDH | AJH180LALDH | AJH198LALDH | AJH216LALDH | AJH234LALDH | AJH252LALDH | AJH270LALDH | AJH288LALDH | AJH306LALDH | AJH324LALDH | AJH342LALDH | AJH360LALDH | AJH378LALDH | AJH396LALDH | AJH414LALDH | AJH432LALDH | |
| Unit 1 Unit 2 Unit 3 | | AJH072LALDH AJH090LALDH AJH108LALDH | AJH090LALDH AJH108LALDH AJH126LALDH | AJH108LALDH AJH126LALDH AJH144LALDH | AJH126LALDH AJH144LALDH AJH162LALDH | AJH144LALDH AJH162LALDH AJH180LALDH | AJH162LALDH AJH180LALDH AJH198LALDH | AJH180LALDH AJH198LALDH AJH216LALDH | AJH198LALDH AJH216LALDH AJH234LALDH | AJH216LALDH AJH234LALDH AJH252LALDH | AJH234LALDH AJH252LALDH AJH270LALDH | AJH252LALDH AJH270LALDH AJH288LALDH | AJH270LALDH AJH288LALDH AJH306LALDH | AJH288LALDH AJH306LALDH AJH324LALDH | AJH306LALDH AJH324LALDH AJH342LALDH | AJH324LALDH AJH342LALDH AJH360LALDH | AJH342LALDH AJH360LALDH AJH378LALDH | AJH360LALDH AJH378LALDH AJH396LALDH | AJH378LALDH AJH396LALDH AJH414LALDH | AJH396LALDH AJH414LALDH AJH432LALDH | AJH414LALDH AJH432LALDH AJH450LALDH | AJH432LALDH AJH450LALDH AJH468LALDH | |
| Maximum connectable indoor units* | | 17 | 21 | 26 | 30 | 34 | 39 | 43 | 47 | 52 | 56 | 60 | 64 | 64 | 64 | 64 | 64 | 64 | 64 | 64 | 64 | 64 | |
| Connectable capacity range of indoor units | kW | 11.2-33.6 | 14.0-42.0 | 16.8-50.2 | 20.0-60.0 | 22.5-67.5 | 25.2-75.6 | 28.0-84.0 | 31.2-93.6 | 34.0-102.0 | 36.5-109.5 | 39.3-117.7 | 42.5-127.5 | 45.0-135.0 | 47.7-143.1 | 50.5-151.5 | 53.3-159.7 | 56.5-169.5 | 59.0-177.0 | 61.8-185.2 | 65.0-195.0 | 67.5-202.5 | |
| Power source | 3-phase, 4-wire, ~400 V, 50 Hz | | | | | | | | | | | 3-phase, 4-wire, ~400 V, 50 Hz | | | | | | | | | | | |
| Capacity | Cooling | 22.4 | | | | | | | | | | | 22.4 | | | | | | | | | | |
| | Nominal Heating | 28.0 | | | | | | | | | | | 28.0 | | | | | | | | | | |
| | Max. Heating | 33.5 | | | | | | | | | | | 33.5 | | | | | | | | | | |
| Input power | Cooling | 5.95 | | | | | | | | | | | 5.95 | | | | | | | | | | |
| | Nominal Heating | 5.42 | | | | | | | | | | | 5.42 | | | | | | | | | | |
| | Max. Heating | 6.26 | | | | | | | | | | | 6.26 | | | | | | | | | | |
| EER | Cooling | 3.76 | | | | | | | | | | | 3.76 | | | | | | | | | | |
| | Nominal Heating | 4.13 | | | | | | | | | | | 4.13 | | | | | | | | | | |
| | Max. Heating | 3.99 | | | | | | | | | | | 3.99 | | | | | | | | | | |
| SEER | Cooling | 7.09 | | | | | | | | | | | 7.09 | | | | | | | | | | |
| SCOP | Heating | 3.83 | | | | | | | | | | | 3.83 | | | | | | | | | | |
| ηc | Cooling | 281.0 | | | | | | | | | | | 281.0 | | | | | | | | | | |
| | Heating | 150.0 | | | | | | | | | | | 150.0 | | | | | | | | | | |
| ηh | High | 11,100 | | | | | | | | | | | 11,100 | | | | | | | | | | |
| Air flow rate | High | 13,000 | | | | | | | | | | | 13,000 | | | | | | | | | | |
| Sound pressure level**/Power level | Cooling | 58/79 | | | | | | | | | | | 58/79 | | | | | | | | | | |
| | Heating | 59/80 | | | | | | | | | | | 59/80 | | | | | | | | | | |
| Max. External static pressure | Pa | 82 | | | | | | | | | | | 82 | | | | | | | | | | |
| Compressor motor output | kW | 7.5 | | | | | | | | | | | 7.5 | | | | | | | | | | |
| Heat exchanger fin | Blue fin | Blue fin | | | | | | | | | | | Blue fin | | | | | | | | | | |
| Net Dimensions | Height | 1,690 | | | | | | | | | | | 1,690 | | | | | | | | | | |
| | Width | 930 | | | | | | | | | | | 930 | | | | | | | | | | |
| | Depth | 765 | | | | | | | | | | | 765 | | | | | | | | | | |
| Weight | kg | 252 | | | | | | | | | | | 252 | | | | | | | | | | |
| Refrigerant | Type (Global Warming Potential) | R410A (2,088) | | | | | | | | | | | R410A (2,088) | | | | | | | | | | |
| | Charge | 11.7 (24.4) | | | | | | | | | | | 11.7 (24.4) | | | | | | | | | | |
| Connection pipe diameter | Liquid | 12.70 | | | | | | | | | | | 12.70 | | | | | | | | | | |
| | Gas | 22.22 | | | | | | | | | | | 22.22 | | | | | | | | | | |
| Operating Range | Cooling | -15 to 46 | | | | | | | | | | | -15 to 46 | | | | | | | | | | |
| | Heating | -20 to 21 | | | | | | | | | | | -20 to 21 | | | | | | | | | | |

Energy Efficiency Combination

| Rated capacity range | HP | 16 | 20 | 24 | 26 | 28 | 30 | 32 | 34 | 36 | 38 | 40 | 42 | 44 | |
|--|---------------------------------|---|---|---|---|---|---|---|---|---|---|---|---|---|--|
| Model name | | AJH144LALDH | AJH180LALDH | AJH216LALDH | AJH252LALDH | AJH288LALDH | AJH324LALDH | AJH360LALDH | AJH396LALDH | AJH432LALDH | AJH468LALDH | AJH504LALDH | AJH540LALDH | AJH576LALDH | |
| Unit 1 Unit 2 Unit 3 | | AJH072LALDH AJH090LALDH AJH108LALDH | AJH108LALDH AJH126LALDH AJH144LALDH | AJH126LALDH AJH144LALDH AJH162LALDH | AJH144LALDH AJH162LALDH AJH180LALDH | AJH162LALDH AJH180LALDH AJH198LALDH | AJH180LALDH AJH198LALDH AJH216LALDH | AJH198LALDH AJH216LALDH AJH234LALDH | AJH216LALDH AJH234LALDH AJH252LALDH | AJH234LALDH AJH252LALDH AJH270LALDH | AJH252LALDH AJH270LALDH AJH288LALDH | AJH270LALDH AJH288LALDH AJH306LALDH | AJH288LALDH AJH306LALDH AJH324LALDH | AJH306LALDH AJH324LALDH AJH342LALDH | |
| Maximum connectable indoor units* | | 34 | 43 | 52 | 56 | 60 | 64 | 64 | 64 | 64 | 64 | 64 | 64 | | |
| Connectable capacity range of indoor units | kW | 22.4-67.2 | 28.0-83.8 | 33.6-100.8 | 36.4-109.2 | 39.2-117.4 | 42.4-127.2 | 44.7-134.1 | 48.0-143.8 | 50.3-150.7 | 53.5-160.5 | 56.8-170.2 | 60.0-180.0 | 62.5-187.5 | |
| Power source | 3-phase, 4-wire, ~400 V, 50 Hz | | | | | | | 3-phase, 4-wire, ~400 V, 50 Hz | | | | | | | |
| Capacity | Cooling | 44.8 | | | | | | | 44.8 | | | | | | |
| | Nominal Heating | 55.9 | | | | | | | 55.9 | | | | | | |
| | Max. Heating | 67.2 | | | | | | | 67.2 | | | | | | |
| Input power | Cooling | 11.90 | | | | | | | 11.90 | | | | | | |
| | Nominal Heating | 10.84 | | | | | | | 10.84 | | | | | | |
| | Max. Heating | 12.52 | | | | | | | 12.52 | | | | | | |
| EER | Cooling | 3.76 | | | | | | | 3.76 | | | | | | |
| | Nominal Heating | 4.13 | | | | | | | 4.13 | | | | | | |
| | Max. Heating | 3.99 | | | | | | | 3.99 | | | | | | |
| SEER | Cooling | 7.09 | | | | | | | 7.09 | | | | | | |
| SCOP | Heating | 3.83 | | | | | | | 3.83 | | | | | | |
| ηc | Cooling | 281.0 | | | | | | | 281.0 | | | | | | |
| | Heating | 150.0 | | | | | | | 150.0 | | | | | | |
| ηh | High | 11,100 | | | | | | | 11,100 | | | | | | |
| Air flow rate | High | 13,000 | | | | | | | 13,000 | | | | | | |
| Sound pressure level**/Power level | Cooling | 61/82 | | | | | | | 61/82 | | | | | | |
| | Heating | 62/83 | | | | | | | 62/83 | | | | | | |
| Max. External static pressure | Pa | 82 | | | | | | | 82 | | | | | | |
| Compressor motor output | kW | 7.5 | | | | | | | 7.5 | | | | | | |
| Heat exchanger fin | Blue fin | Blue fin | | | | | | | Blue fin | | | | | | |
| Net Dimensions | Height | 1,690 | | | | | | | 1,690 | | | | | | |
| | Width | 930 | | | | | | | 930 | | | | | | |
| | Depth | 765 | | | | | | | 765 | | | | | | |
| Weight | kg | 252 | | | | | | | 252 | | | | | | |
| Refrigerant | Type (Global Warming Potential) | R410A (2,088) | | | | | | | R410A (2,088) | | | | | | |
| | Charge | 11.7 (24.4) | | | | | | | 11.7 (24.4) | | | | | | |
| Connection pipe diameter | Liquid | 12.70 | | | | | | | 12.70 | | | | | | |
| | Gas | 28.58 | | | | | | | 28.58 | | | | | | |
| Operating Range | Cooling | -5 to 46 | | | | | | | -5 to 46 | | | | | | |
| | Heating | -20 to 21 | | | | | | | -20 to 21 | | | | | | |

Note: Specifications are subject to the following conditions:
Cooling: Indoor temperature of 27°CDB/19°CWB, and outdoor temperature of 35°CDB/24°CWB.
Heating: Indoor temperature of 20°CDB/15°CWB, and outdoor temperature of 7°CDB/6°CWB.
Pipe length: 7.5 m; Height difference between outdoor unit and indoor unit: 0 m.

When cooling operation is conducted at an outdoor air temperature below -5°C,
the outdoor unit must be installed in a position that is higher than or equal to that of the indoor units.
* These specifications are determined by ducted combination.
* Multiple outdoor units are not certified by Eurovent.

*1 Minimum connectable indoor unit number is 2.
*2 However, the ARXC72 and ARXC90 can be used with a signal connection.
* The noise level is the value measured in an anechoic room.

When measured in an actual installation, the measured value is typically larger than the indicated value due to ambient noise and reflections.
* These specifications are determined by ducted combination.

VRF INDOOR UNITS

















17 types and 95 models available to meet the requirements of any building design.

Indoor units for the VRF Systems are compact, highly efficient, quiet, and user-friendly. Fujitsu General offers a variety of types and capacities for its indoor units that are easy to install and maintain. In addition, a variety of optional parts are available to provide an even more desirable air conditioning experience to users.

- V-054 INDOOR UNITS LINEUP
- V-056 Compact Cassette (Grid type)
- V-058 Cassette Slim type (Circular Flow)
- V-060 Cassette Large type (Circular Flow)
- V-062 Cassette (One-way Flow type)
- V-064 3D Flow Cassette
- V-066 Low Static Pressure Duct/Mini Duct
- V-068 Low Static Pressure Duct/Slim Duct/Slim Concealed Floor
- V-070 Low Static Pressure Duct
- V-072 Medium Static Pressure Duct
- V-074 High Static Pressure Duct
- V-076 Compact Floor
- V-078 Floor/Ceiling
- V-080 Ceiling
- V-082 Wall-mounted (EEV Internal/external)



VRF Indoor Unit Lineup

| Capacity range (kW) | | | 1.1 | 2.2 | 2.8 | 3.6 | | 4.0 | 4.5 | 5.6 | 7.1 | 9.0 | 10.0 | 11.2 | 12.5 | 14.0 | 18.0 | 22.4 | 25.0 | 28.0 | |
|---------------------|--|--|---|--|---------------|---------------|---------------|---------------|---------------|---------------|---------------|---------------|---------------|---------------|---------------|---------------|------|-----------------|-----------------|-----------------|-----------------|
| Class | | | 4 | 7 | 9 | 12 | | 14 | 14 | 18 | 24 | 30 | 34 | 36 | 45 | 54 | 60 | 72 | 90 | 96 | |
| Cassette | Compact type | Compact Grid type/Standard type |  | AUXB 004 GLEH | AUXB 007 GLEH | AUXB 009 GLEH | AUXB 012 GLEH | | AUXB 014 GLEH | AUXB 018 GLEH | AUXB 024 GLEH | | | | | | | | | | |
| | Slim type | Circular Flow |  | | | | | | | AUXM 018 GLEH | AUXM 024 GLEH | AUXM 030 GLEH | | | | | | | | | |
| | Large type | Circular Flow |  | | | | | | | AUXK 018 GLEH | AUXK 024 GLEH | AUXK 030 GLEH | AUXK 034 GLEH | AUXK 036 GLEH | AUXK 045 GLEH | AUXK 054 GLEH | | | | | |
| | One-way Flow type | One-way Flow |  004 - 012 014 - 024 | AUXV 004 GLEH | AUXV 007 GLEH | AUXV 009 GLEH | AUXV 012 GLEH | | AUXV 014 GLEH | AUXV 018 GLEH | AUXV 024 GLEH | | | | | | | | | | |
| | 3D Flow type | 3D Flow |  | | | | | | | AUXS 018 GLEH | AUXS 024 GLEH | | | | | | | | | | |
| Duct | Low Static Pressure Duct | Mini Duct (With drain pump) |  004 - 014 018 024 | ARXK 004 GLGH | ARXK 007 GLGH | ARXK 009 GLGH | ARXK 012 GLGH | | ARXK 014 GLGH | ARXK 018 GLGH | ARXK 024 GLGH | | | | | | | | | | |
| | | Slim Duct (With drain pump) |  04/007 - 014 018 024 | ARXD 04 GALH*2 | ARXD 007 GLEH | ARXD 009 GLEH | ARXD 012 GLEH | | ARXD 014 GLEH | ARXD 018 GLEH | ARXD 024 GLEH | | | | | | | | | | |
| | | High Efficiency*3 |  | | | | | | | ARXP 018 GLFH | | ARXP 030 GLFH | | | | | | | | | |
| | Medium static pressure duct | Normal |  | | | | | | | | ARXA 024 GLEH | ARXA 030 GLEH | | ARXA 036 GLEH | ARXA 045 GLEH | | | | | | |
| | | High Static Pressure Duct | Normal |  036/45 - 60 072 - 090 096 | | | | | | | | | | | ARXC 036 GTEH | ARXC 045 GTEH | | ARXC 060 GTEH*1 | ARXC 072 GTEH*1 | ARXC 090 GTEH*1 | ARXC 096 GTEH*1 |
| Floor | Floor (*Same as Ceiling models) |  | | | | ABHA 012 GTEH | | ABHA 014 GTEH | ABHA 018 GTEH | ABHA 024 GTEH | | | | | | | | | | | |
| | Slim Concealed Floor (*Same as Slim Duct models) |  04/007 - 014 018 024 | ARXD 04 GALH*2 | ARXD 007 GLEH | ARXD 009 GLEH | ARXD 012 GLEH | | ARXD 014 GLEH | ARXD 018 GLEH | ARXD 024 GLEH | | | | | | | | | | | |
| | Compact Floor |  | AGHA 004 GCGH | AGHA 007 GCGH | AGHA 009 GCGH | AGHA 012 GCGH | | AGHA 014 GCGH | | | | | | | | | | | | | |
| | Compact Floor (EEV external) |  | AGHE 004 GCEH | AGHE 007 GCEH | AGHE 009 GCEH | AGHE 012 GCEH | | AGHE 014 GCEH | | | | | | | | | | | | | |
| | | | This model requires the EV kit to be connected. | | | | | | | | | | | | | | | | | | |
| Ceiling | |  012 - 024 030 - 054 | | | | ABHA 012 GTEH | | ABHA 014 GTEH | ABHA 018 GTEH | ABHA 024 GTEH | ABHA 030 GTEH | | ABHA 036 GTEH | ABHA 045 GTEH | ABHA 054 GTEH | | | | | | |
| Wall-mounted type | Wall-mounted type |  004 - 014 18 - 24 030 - 034 | ASHA 004 GCGH | ASHA 007 GCGH | ASHA 009 GCGH | ASHA 012 GCGH | | ASHA 014 GCGH | | ASHA 18 GBCH | ASHA 24 GBCH | ASHA 030 GTEH | ASHA 034 GTEH | | | | | | | | |
| | Wall-mounted type (EEV external) |  004 - 014 | ASHE 004 GCEH | ASHE 007 GCEH | ASHE 009 GCEH | ASHE 012 GCEH | | ASHE 014 GCEH | | | | | | | | | | | | | |
| | | | This model requires the EV kit to be connected. | | | | | | | | | | | | | | | | | | |

*1: ARXC060/072/090/096G cannot be connected to J-IVS/J-IV Series.
 *2: ARXD04GALH cannot be connected to J-IVS/J-IVL/VR-IV Series.
 *3: Production by order
 Specifications and design are subject to change without notice.

Compact Cassette Grid type



Compact and stylish panel

The compact and stylish panel fits nicely into a grid type ceiling. The linear design is a perfect fit into a grid of 620 mm × 620 mm in the ceiling.

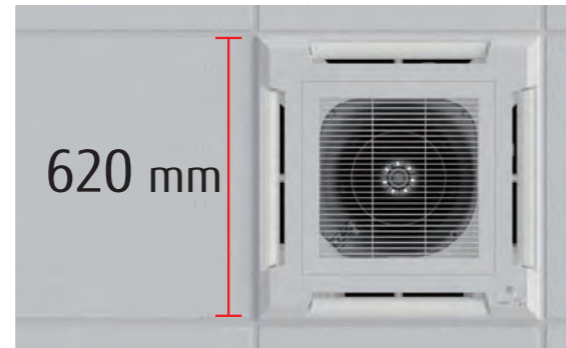

Easy maintenance

You can access the unit for maintenance just by removing a ceiling panel right next to the grille. As no inspection hole needs to be cut through the ceiling, no additional construction cost is incurred.



The air inlet grille can be installed to open in any direction for easy maintenance.



Flexible installation

The unit fits nicely into the decor of a grid type ceiling and can be installed near a lighting or a ventilation opening.



High ceiling mode

The cassette can be installed up to a height of 3.0 m. (012/014/018/024).

| Model code | Maximum height from floor to ceiling (m) | |
|------------|--|-------------------|
| | Standard mode | High ceiling mode |
| 004 | 2.7 | - |
| 007 | 2.7 | - |
| 009 | 2.7 | - |
| 012 | 2.7 | 3.0 |
| 014 | 2.7 | 3.0 |
| 018 | 2.7 | 3.0 |
| 024 | 2.7 | 3.0 |

Model: AUXB004GLEH / AUXB007GLEH / AUXB009GLEH
AUXB012GLEH / AUXB014GLEH / AUXB018GLEH
AUXB024GLEH



Specifications

| Model name | | AUXB004GLEH | AUXB007GLEH | AUXB009GLEH | AUXB012GLEH | AUXB014GLEH | AUXB018GLEH | AUXB024GLEH |
|---------------------------------|----------------------------|-----------------------------|-------------------------------|-----------------|-----------------|-----------------|-----------------|-----------------|
| Power source | | Single phase, ~230 V, 50 Hz | | | | | | |
| Capacity | Cooling | 1.1 | 2.2 | 2.8 | 3.6 | 4.5 | 5.6 | 7.1 |
| | Heating | 1.3 | 2.8 | 3.2 | 4.1 | 5.0 | 6.3 | 8.0 |
| Input power | | 23 | 25 | 25 | 29 | 35 | 36 | 84 |
| Airflow rate | High | 530/530 | 540 | 550 | 600 | 680 | 710 | 1,030 |
| | Med-High | 490/480 | 500 | 520 | 560 | 620 | 660 | 910 |
| | Med | 450/430 | 460 | 480 | 520 | 560 | 590 | 790 |
| | Med-Low | 420/380 | 420 | 440 | 480 | 500 | 520 | 680 |
| | Low | 390/340 | 390 | 400 | 430 | 440 | 460 | 560 |
| Quiet | | 350/300 | 350 | 350 | 390 | 390 | 400 | 450 |
| Sound pressure level | High | 34/34 | 34 | 35 | 37 | 38 | 41 | 50 |
| | Med-High | 32/31 | 32 | 33 | 34 | 37 | 39 | 46 |
| | Med | 30/29 | 30 | 31 | 33 | 34 | 36 | 43 |
| | Med-Low | 28/26 | 28 | 29 | 31 | 32 | 33 | 39 |
| | Low | 27/24 | 27 | 27 | 29 | 30 | 30 | 35 |
| Quiet | | 25/21 | 25 | 25 | 27 | 27 | 27 | 30 |
| Net Dimensions (H × W × D) | | mm | 245 × 570 × 570 | 245 × 570 × 570 | 245 × 570 × 570 | 245 × 570 × 570 | 245 × 570 × 570 | 245 × 570 × 570 |
| Weight | | kg | 14.5 | 15 | 15 | 15 | 17 | 17 |
| Connection pipe diameter | Liquid (Flare) | mm | 6.35 | 6.35 | 6.35 | 6.35 | 6.35 | 9.52 |
| | Gas (Flare) | mm | 9.52 | 9.52 | 9.52 | 12.70 | 12.70 | 15.88 |
| Drain Hose Diameter (I.D./O.D.) | | | 25/32 | | | | | |
| Cassette Grille | Model name | | UTG-UFGE-W/UTG-UFGE-W | | | | | |
| | Net Dimensions (H × W × D) | mm | 50 × 620 × 620/50 × 700 × 700 | | | | | |
| Weight | | kg | 2.3/2.6 | | | | | |

Note: Specifications are subject to the following conditions:
Cooling: Indoor temperature of 27°CDB/19°CWB, and outdoor temperature of 35°CDB/24°CWB.
Heating: Indoor temperature of 20°CDB/(15°CWB), and outdoor temperature of 7°CDB/6°CWB.
Pipe length: 7.5 m; Height difference between outdoor unit and indoor unit: 0 m. Voltage: 230 [V]
*1: This value is under cooling operation.

Optional parts

*For more details, please refer to the chapter "Optional parts".

| | | | |
|-----------------------------------|----------|-----------------------------|--------------------------------------|
| Air Outlet Shutter Plate: | UTR-YDZB | Cassette Grille: | UTG-UFGE-W, UTG-UFGE-W |
| Fresh Air Intake Kit: | UTZ-VXAA | External power supply unit: | UTZ-GXXA, UTZ-GXXC* |
| Insulation kit for high humidity: | UTZ-KXGC | WLAN adapter: | UTY-TFSXZ1, UTY-TFSXJ3, FG-AC-WIF1Z1 |
| Silver Ion Filter: | UTD-HFAA | | |

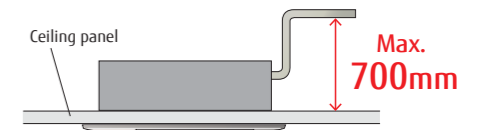

Dimensions

(Unit: mm)

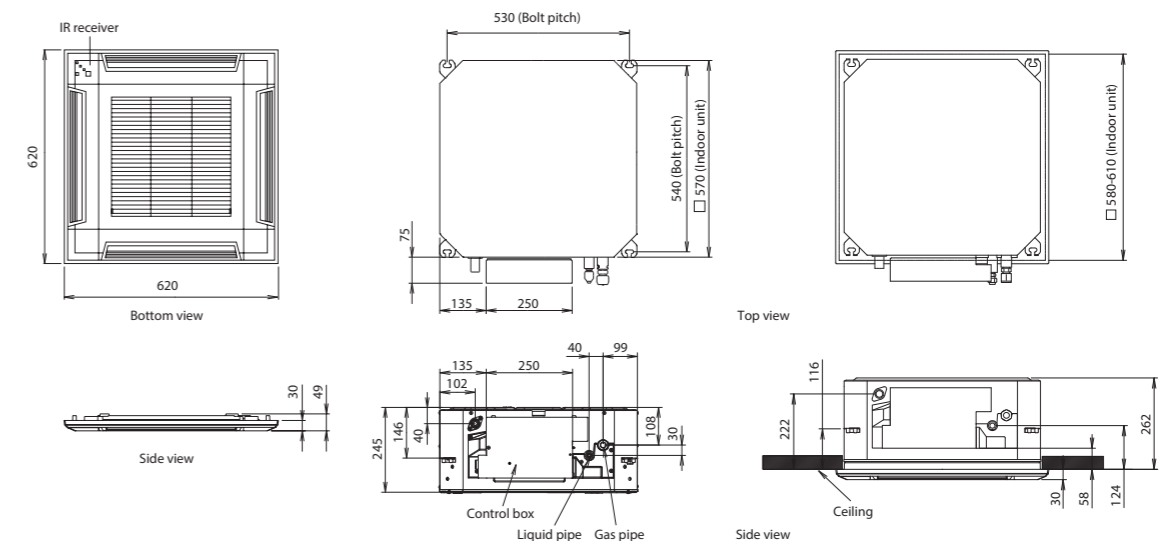

Cassette Slim type Circular Flow



Unique circular flow design

This Cassette type air conditioner is equipped with a high performance DC fan motor, a turbo fan, and a louver to propel powerful airflows in all directions.

- Ø7 mm high-density heat exchanger
- New DC fan motor
- High-efficiency turbo fan
- Seamless airflow louver

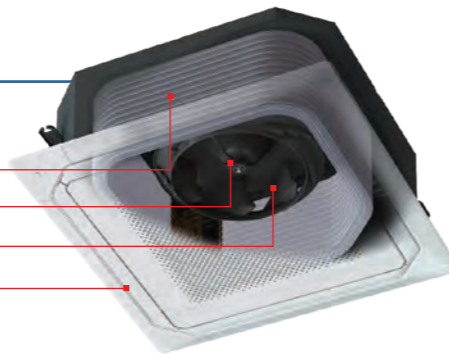

Uniform temperature air conditioning

Achieve a comfortable air conditioning spread to every corner of the room thanks to the circular flow and wide vertical airflow.

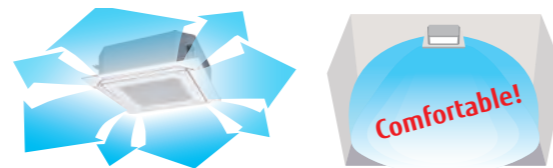

Individual louver control

Each louver can be set individually by the Touch panel wired remote controller so the user can enjoy the comfort of different directional airflows according to the room layout.

* UTY-RNRGZ5 Wired remote controller with touch panel and UTY-DCGGZ2 Central remote controller only



Comfortable air conditioning by preventing direct blowing of cold air and by providing swinging air flow simultaneously.

Provides efficient air conditioning based on the room layout

The Occupancy sensor contributes to further energy savings.

Energy saving operation starts automatically by detecting the motion of a person. Two modes of save operation mode and stop mode can be selected.

* UTY-RNRGZ5 Wired remote controller with touch panel and UTY-DCGGZ2 Central remote controller only



Occupancy sensor (Optional)

- 2 modes are available to choose from:
- Auto economy mode** The air conditioner switches to operate on reduced power when it detects that the room is unoccupied.
 - Auto-off mode** The air conditioner stops operating when it detects that the room is unoccupied.

Model: AUXM018GLEH / AUXM024GLEH / AUXM030GLEH



Specifications

| Model name | | | AUXM018GLEH | AUXM024GLEH | AUXM030GLEH |
|---------------------------------|------------------------|-----------------------|-----------------------------|-------------|-------------|
| Power source | | | Single phase, ~230 V, 50 Hz | | |
| Capacity | Cooling | kW | 5.6 | 7.1 | 9.0 |
| | Heating | | 6.3 | 8.0 | 10.0 |
| Input power | W | | 20 | 25 | 49 |
| Airflow rate | High | m³/h | 1,050 | 1,120 | 1,470 |
| | Med-High | | 930 | 1,050 | 1,160 |
| | Med | | 900 | 930 | 1,070 |
| | Med-Low | | 870 | 900 | 930 |
| | Low | | 810 | 870 | 900 |
| | Quiet | | 780 | 780 | 780 |
| Sound pressure level | High | dB(A) | 33 | 35 | 40 |
| | Med-High | | 32 | 33 | 36 |
| | Med | | 31 | 32 | 34 |
| | Med-Low | | 30 | 31 | 32 |
| | Low | | 29 | 30 | 31 |
| | Quiet | | 28 | 28 | 28 |
| Dimensions (H × W × D) | mm | | 246 × 840 × 840 | | |
| Weight | kg | | 24.0 | 24.5 | 24.5 |
| Connection pipe diameter | Liquid (Flare) | mm | 6.35 | 9.52 | 9.52 |
| | Gas (Flare) | | 12.70 | 15.88 | 15.88 |
| Drain Hose Diameter (I.D./O.D.) | | | 25/32 | | |
| Cassette Grille | Model name | UTG-UKGC-W/UTG-UKGA-B | | | |
| | Dimensions (H × W × D) | mm | | | |
| | Weight | kg | | | |

Note: Specifications are subject to the following conditions:
 Cooling: Indoor temperature of 27°CDB/19°CWB, and outdoor temperature of 35°CDB/24°CWB.
 Heating: Indoor temperature of 20°CDB/15°CWB, and outdoor temperature of 7°CDB/6°CWB.
 Pipe length: 7.5 m; Height difference between outdoor unit and indoor unit: 0 m. Voltage: 230 [V].
 When AUX*018GLEH is connected to an outdoor unit other than one of the J-IVL Series, the pipe diameter should be Ø9.52/Ø15.88 mm (Liquid/Gas).
 When connecting AUXK036GLEH, AUXK045GLEH, and AUXK054GLEH to an outdoor unit other than the outdoor unit of the J-IVL Series, the gas pipe diameter should be Ø19.05 mm.

Optional parts

*For more details, please refer to the chapter "Optional parts".

- | | | |
|---------------------------------|---|--|
| Occupancy sensor Kit: UTY-SHZXC | Air Outlet Shutter Plate: UTR-YDZK | IR Receiver Unit: UTY-LBHXD |
| Wide Panel: UTG-AKXA-W | Insulation kit for high humidity: UTZ-KXRA | WLAN adapter: UTY-TFSXZ1, UTY-TFSXJ3, FG-AC-WIF1Z1 |
| Panel Spacer: UTG-BKXA-W | Cassette Grille: UTG-UKGC-W, UTG-UKGA-B | Silver Ion Filter: UTD-HFRA |
| Fresh air intake kit: UTZ-VXRA | External power supply unit: UTZ-GXXA, UTZ-GXXC* | |

Dimensions

(Unit: mm)

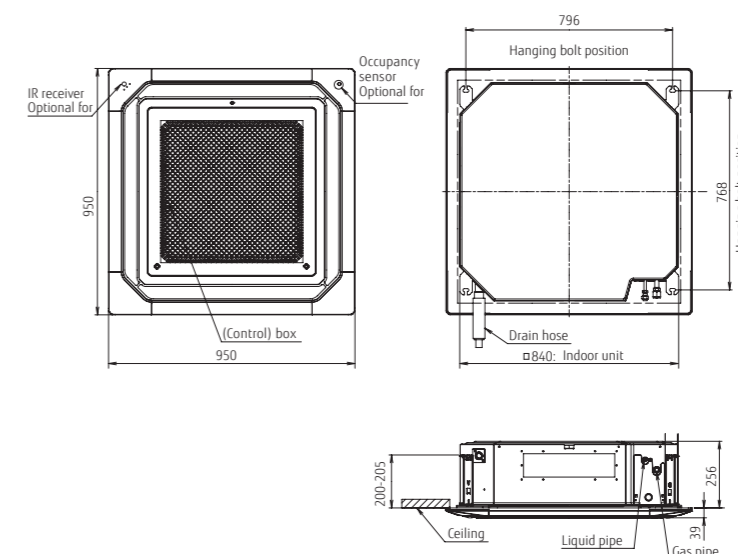

Cassette Large type

Circular Flow



Unique circular flow design

This Cassette type air conditioner is equipped with a high performance DC fan motor, a turbo fan, and a louver to propel powerful airflows in all directions.

- Ø7 mm high-density heat exchanger
- New DC fan motor
- High-efficiency turbo fan
- Seamless airflow louver

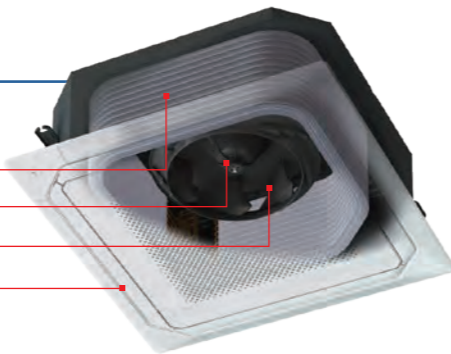

Uniform temperature air conditioning

Achieve a comfortable air conditioning spread to every corner of the room by circular flow and wide vertical airflow.

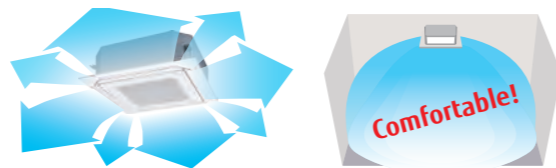

Individual louver control

Each louver can be set individually by the Touch panel wired remote controller so the user can enjoy the comfort of different directional airflows according to the room layout.

* UTY-RNRGZ5 Wired remote controller with touch panel and UTY-DCGGZ2 Central remote controller only



Comfortable air conditioning by preventing direct blowing of cold air and by providing swinging air flow simultaneously.

Provides efficient air conditioning based on the room layout

The Occupancy sensor contributes to further energy savings.

Energy saving operation starts automatically by detecting the motion of a person. Two modes of save operation mode and stop mode can be selected.

* UTY-RNRGZ5 Wired remote controller with touch panel and UTY-DCGGZ2 Central remote controller only



Occupancy sensor (Optional)

- 2 modes are available to choose from:
- Auto economy mode** The air conditioner switches to operate on reduced power when it detects that the room is unoccupied.
 - Auto-off mode** The air conditioner stops operating when it detects that the room is unoccupied.

Model: AUXK018GLEH / AUXK024GLEH / AUXK030GLEH
 AUXK034GLEH / AUXK036GLEH / AUXK045GLEH
 AUXK054GLEH



Specifications

| Model name | AUXK018GLEH | AUXK024GLEH | AUXK030GLEH | AUXK034GLEH | AUXK036GLEH | AUXK045GLEH | AUXK054GLEH |
|---------------------------------|-----------------------------|-----------------------|----------------|-------------|-------------|-------------|-------------|
| Power source | Single phase, ~230 V, 50 Hz | | | | | | |
| Capacity | Cooling | 5.6 | 7.1 | 9.0 | 10.0 | 11.2 | 14.0 |
| | Heating | 6.3 | 8.0 | 10.0 | 11.2 | 12.5 | 16.0 |
| Input power | W | 40 | 40 | 47 | 47 | 61 | 89 |
| Airflow rate | High | 1,420 | 1,420 | 1,440 | 1,440 | 1,620 | 1,820 |
| | Med-High | 1,360 | 1,360 | 1,400 | 1,400 | 1,500 | 1,590 |
| | Med | 1,300 | 1,300 | 1,340 | 1,340 | 1,400 | 1,500 |
| | Med-Low | 1,270 | 1,270 | 1,300 | 1,300 | 1,340 | 1,400 |
| | Low | 1,200 | 1,200 | 1,280 | 1,280 | 1,280 | 1,300 |
| Sound pressure level | Quiet | 1,150 | 1,150 | 1,150 | 1,150 | 1,150 | 1,150 |
| | High | 38 | 38 | 39 | 39 | 41 | 44 |
| | Med-High | 37 | 37 | 38 | 38 | 40 | 42 |
| | Med | 36 | 36 | 37 | 37 | 38 | 40 |
| | Med-Low | 35 | 35 | 36 | 36 | 37 | 38 |
| Low | 34 | 34 | 35 | 35 | 36 | 36 | |
| Quiet | 33 | 33 | 33 | 33 | 33 | 33 | |
| Dimensions (H × W × D) | mm | 288 × 840 × 840 | | | | | |
| Weight | kg | 26.5 | 26.5 | 29.5 | 29.5 | 29.5 | 29.5 |
| Connection pipe diameter | Liquid (Flare) | 6.35 | 9.52 | 9.52 | 9.52 | 9.52 | 9.52 |
| | Gas (Flare) | 12.70 | 15.88 | 15.88 | 15.88 | 15.88 | 15.88 |
| Drain Hose Diameter (I.D./O.D.) | | 25/32 | | | | | |
| Cassette Grille | Model name | UTG-UKGC-W/UTG-UKGA-B | | | | | |
| | Dimensions (H × W × D) | mm | 53 × 950 × 950 | | | | |
| Weight | kg | 6.0 | | | | | |

Note: Specifications are subject to the following conditions:
 Cooling: Indoor temperature of 27°CDB/19°CWB, and outdoor temperature of 35°CDB/24°CWB.
 Heating: Indoor temperature of 20°CDB/15°CWB, and outdoor temperature of 7°CDB/6°CWB.
 Pipe length: 7.5 m; Height difference between outdoor unit and indoor unit: 0 m. Voltage: 230 [V].
 When AUX*018GLEH is connected to an outdoor unit other than one of the J-IVL Series, the pipe diameter should be Ø9.52/Ø15.88 mm (Liquid/Gas).
 When connecting AUXK036GLEH, AUXK045GLEH, and AUXK054GLEH to an outdoor unit other than the outdoor unit of the J-IVL Series, the gas pipe diameter should be Ø19.05 mm.

Optional parts

*For more details, please refer to the chapter "Optional parts".

- Occupancy sensor Kit: UTY-SHZXC
- Wide Panel: UTG-AKXA-W
- Panel Spacer: UTG-BKXA-W
- Fresh air intake kit: UTZ-VXRA
- Air Outlet Shutter Plate: UTR-YDZK
- Insulation kit for high humidity: UTZ-KXRA
- Cassette Grille: UTG-UKGC-W, UTG-UKGA-B
- External power supply unit: UTZ-GXXA, UTZ-GXXC*
- IR Receiver Unit: UTY-LBHXD
- WLAN adapter: UTY-TFSXZ1, UTY-TFSXJ3, FG-AC-WIF1Z1
- Silver Ion Filter: UTD-HFRA

Dimensions

(Unit: mm)

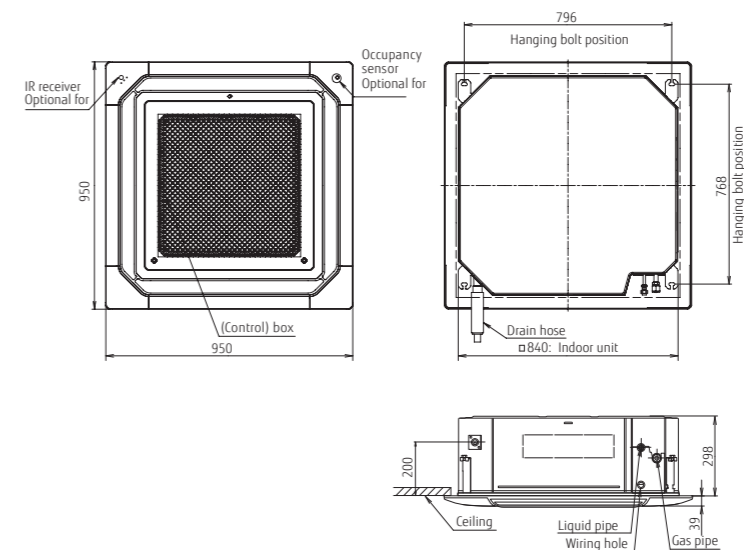

Cassette

One-way Flow type



Compact chassis size

The compact size allows easy installation in a variety of commercial facilities and environments.

- The height of the chassis is less than 200 mm for all models.
- All 4 to 12 kBTu models are less than 1,000 mm wide.
- The depth of the chassis is 570 mm, which fits nicely into a grid type ceiling.



| Dimensions (Panel size) | | (Unit: mm) | | | | | | |
|-------------------------|--|------------|-----------|---|----|----|---------------|----|
| | | 4 | 7 | 9 | 12 | 14 | 18 | 24 |
| H | | | 198 (43) | | | | 198 (43) | |
| W | | | 785 (950) | | | | 1,190 (1,360) | |
| D | | | 570 (620) | | | | 570 (620) | |

Wide airflow range

A large flap with a wide range of movements, equipped with louvers arranged triangularly, sends air into every corner of the room.



In cooling mode, the left/right airflow reaches every corner of the room without directly touching the human body to provide comfortable air conditioning.

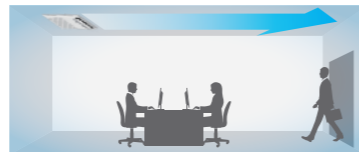

In heating mode, warm air is directed downward toward the floor to warm the feet and lower body, while the head is kept relatively cool.

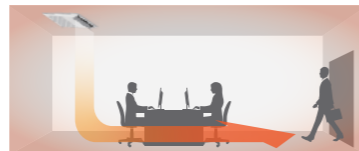

Note: This is a conceptual drawing. The performance of an air conditioner may vary depending on where it is installed, the size of the room, and its distance from the wall.

Quiet mode

The low operating noise makes the model ideal for use in hotel rooms.



Model: AUXV004GLEH / AUXV007GLEH / AUXV009GLEH
 AUXV012GLEH / AUXV014GLEH / AUXV018GLEH
 AUXV024GLEH



AUXV004/007/009/012GLEH



AUXV014/018/024GLEH

Specifications

| Model name | | AUXV004GLEH | AUXV007GLEH | AUXV009GLEH | AUXV012GLEH | AUXV014GLEH | AUXV018GLEH | AUXV024GLEH |
|---------------------------------|----------------------------|-----------------------------|-----------------|-----------------|------------------|-------------------|-------------------|-------------------|
| Power source | | Single phase, ~230 V, 50 Hz | | | | | | |
| Capacity | Cooling | 1.1 | 2.2 | 2.8 | 3.6 | 4.5 | 5.6 | 7.1 |
| | Heating | 1.3 | 2.8 | 3.2 | 4.0 | 5.0 | 6.3 | 8.0 |
| Input power | | 30/30 | 42/42 | 42/42 | 60/60 | 38/38 | 56/56 | 99/99 |
| Airflow rate* | High | 460 | 550 | 550 | 670 | 720 | 890 | 1,150 |
| | Med-High | 440 | 440 | 440 | 520 | 660 | 840 | 1,020 |
| | Med | 420 | 420 | 420 | 480 | 630 | 770 | 940 |
| | Med-Low | 400 | 400 | 400 | 450 | 600 | 710 | 790 |
| | Low | 380 | 380 | 380 | 410 | 580 | 660 | 700 |
| | Quiet | 360 | 360 | 360 | 360 | 550 | 580 | 610 |
| Sound pressure level* | High | 38 | 42 | 42 | 45 | 37 | 44 | 49 |
| | Med-High | 37 | 37 | 37 | 41 | 36 | 43 | 47 |
| | Med | 36 | 36 | 36 | 39 | 35 | 40 | 45 |
| | Med-Low | 35 | 35 | 35 | 38 | 34 | 38 | 42 |
| | Low | 33 | 33 | 33 | 36 | 33 | 36 | 39 |
| | Quiet | 32 | 32 | 32 | 32 | 32 | 34 | 36 |
| Net Dimensions (H × W × D) | | mm 198 × 785 × 570 | 198 × 785 × 570 | 198 × 785 × 570 | 198 × 785 × 570 | 198 × 1,190 × 570 | 198 × 1,190 × 570 | 198 × 1,190 × 570 |
| Weight | | kg 18 | 19 | 19 | 19 | 26 | 26 | 27 |
| Connection pipe diameter | Liquid (Flare) | mm 6.35 | 6.35 | 6.35 | 6.35 | 6.35 | 6.35 | 9.52 |
| | Gas (Flare) | mm 9.52 | 9.52 | 9.52 | 12.70 | 12.70 | 12.70 | 15.88 |
| Drain Hose Diameter (I.D./O.D.) | | | | | 25/32 | | | |
| Cassette Grille | Model name | UTG-UNGA-W | | | UTG-UNGB-W | | | |
| | Net Dimensions (H × W × D) | mm 43 × 950 × 620 | | | 43 × 1,360 × 620 | | | |
| | Weight | kg 6.5 | | | 8.5 | | | |

Note: Specifications are subject to the following conditions:
 Cooling: Indoor temperature of 27°CDB/19°CWB, and outdoor temperature of 35°CDB/24°CWB.
 Heating: Indoor temperature of 20°CDB/15°CWB, and outdoor temperature of 7°CDB/6°CWB.
 Pipe length: 7.5 m; Height difference between outdoor unit and indoor unit: 0 m. Voltage: 230 [V]

Optional parts

- WLAN adapter: UTY-TFSXZ1, UTY-TFSXJ3, FG-AC-WIF1Z1
- IR Receiver Unit: UTY-TRHX
- Cassette Grille: UTG-UNGA-W/UTG-UNGB-W
- External power supply unit: UTZ-GXXA, UTZ-GXXC*

Flexible Installation

The L-shaped pipe kit allows for more flexible installation. Equipped with a built-in drain pump as standard, which enables a maximum pipe height difference of 700 m from the ceiling.

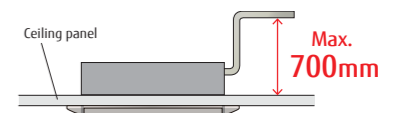

Dimensions

(Unit: mm)

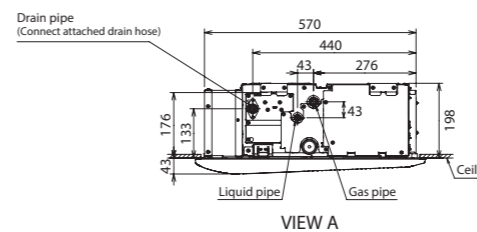
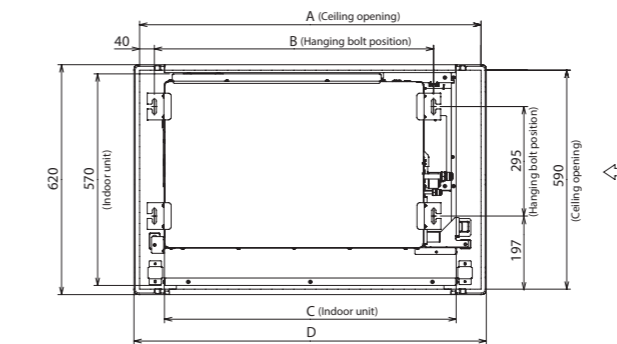

| | AUXV004-012 | AUXV014-024 |
|---|-------------|-------------|
| A | 920 | 1,330 |
| B | 752 | 1,152 |
| C | 785 | 1,190 |
| D | 950 | 1,360 |

3D Flow Cassette



3 individually controlled air outlet ports

The Comfortable airflow setting enables the left and right air outlet ports as well as the wide center port to work together to provide a comfortable room environment.

Temperature distribution during cooling and heating (when set to Comfortable airflow)

Testing conditions: Model AUXS024GLEH running cooling operation with the air volume set to "Hi" to maintain the room temperature at 18°C with the outdoor temperature at 35°C, tested in our 40m² environmental test room

Testing conditions: Model AUXS024GLEH running heating operation with the air volume set to "Hi" to maintain the room temperature at 30°C with the outdoor temperature at 7°C, tested in our 40m² environmental test room

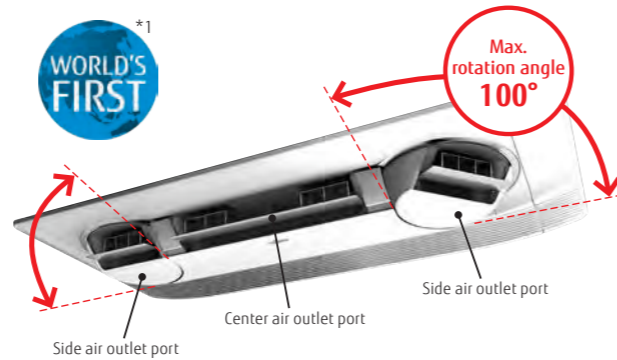

*1: Announced 2018. In the category of room air conditioners for the home (source: Fujitsu General Limited).

Individual airflow setting

The individual airflow setting function optimizes the airflow direction to match the room layout.

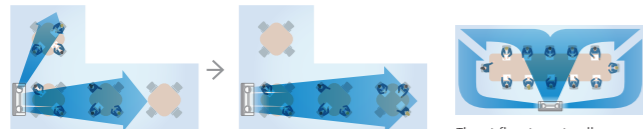

Adjusts airflows from the side air outlet ports to match the layout and usage of the room to minimize the amount of wasted airflow.

The airflow is optimally controlled to provide improved comfort in a narrow room.

Individual control of air outlet ports

Individual airflow can be set using a Wired remote controller with touch panel and Central remote controller*. The airflow from each air outlet port can be set individually.

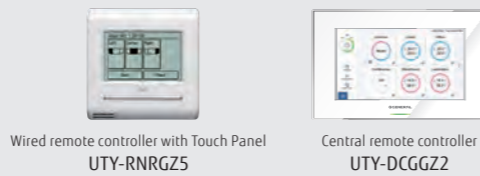

* Feature available only on UTY-RNRGZ5 Wired remote controller with touch panel and UTY-DCGGZ2 Central remote controller

High energy saving

The structural design to take in a larger volume of air and blow air out more smoothly reduces air blowing loss and achieves class-leading energy-saving performance.

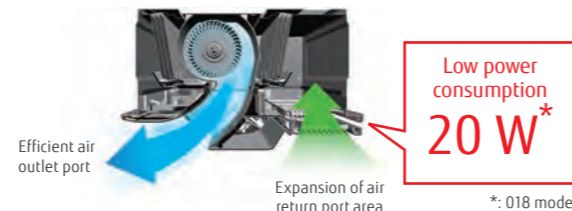

Model: AUXS018GLEH / AUXS024GLEH



Specifications

| Model name | | AUXS018GLEH | AUXS024GLEH |
|---------------------------------|----------------------------|-----------------------------|-------------------|
| Power source | | Single phase, ~230 V, 50 Hz | |
| Capacity | Cooling | 5.60 | 7.10 |
| | Heating | 6.30 | 8.00 |
| Input power | | 20/28 | 34/43 |
| Airflow rate* | High | 750/870 | 950/1,040 |
| | Med-High | 710/830 | 890/990 |
| | Med | 690/780 | 860/930 |
| | Med-Low | 660/740 | 810/880 |
| | Low | 630/700 | 770/840 |
| | Quiet | 540/540 | 540/540 |
| Sound pressure level* | High | 38/41 | 43/46 |
| | Med-High | 36/40 | 42/45 |
| | Med | 35/39 | 41/43 |
| | Med-Low | 35/37 | 40/42 |
| | Low | 33/36 | 38/40 |
| | Quiet | 29/29 | 29/29 |
| Net Dimensions (H × W × D) | | 200 × 1,240 × 500 | 200 × 1,240 × 500 |
| Weight | | 25 | 25 |
| Connection pipe diameter | Liquid (Flare) | 6.35 | 9.52 |
| | Gas (Flare) | 12.70 | 15.88 |
| Drain Hose Diameter (I.D./O.D.) | | 25/32 | |
| Cassette Grille | Model name | UTG-USGA-W | |
| | Net Dimensions (H × W × D) | 85 × 1,350 × 580 | |
| | Weight | 11.5 | |

Note: Specifications are subject to the following conditions:
 Cooling: Indoor temperature of 27°CDB/19°CWB, and outdoor temperature of 35°CDB/24°CWB.
 Heating: Indoor temperature of 20°CDB/15°CWB, and outdoor temperature of 7°CDB/6°CWB.
 Pipe length: 7.5 m; Height difference between outdoor unit and indoor unit: 0 m. Voltage: 230 [V]
 *: Applicable to cooling and heating operation

Optional parts

*For more details, please refer to the chapter "Optional parts."

- WLAN adapter: UTY-TFSXZ1, UTY-TFSXJ3, FG-AC-WIF1Z1
- IR Receiver Unit: UTY-TRHX
- Cassette Grille: UTG-USGA-W
- External power supply unit: UTZ-GXXA, UTZ-GXXC*

Dimensions

(Unit: mm)

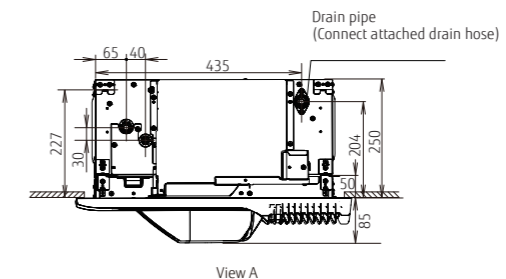
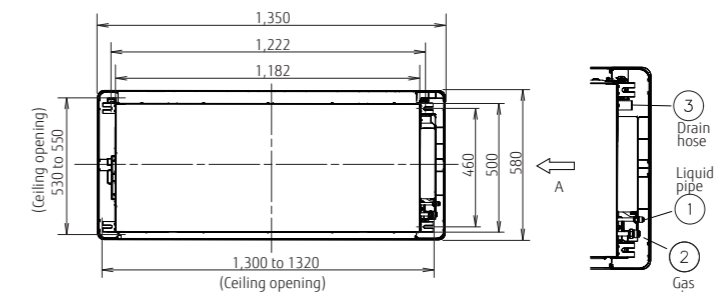

Low Static Pressure Duct Mini Duct (With drain pump)



Space saving design

- Fits into a space 198 mm high and 450 mm deep
- 30% smaller than previous-generation models
- Weighs 16 kg, 10% lighter

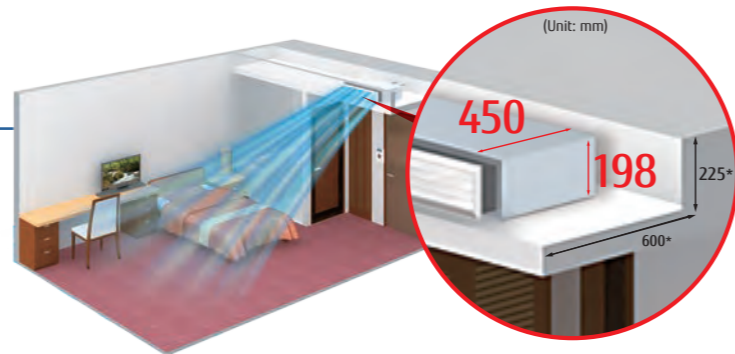

*: Minimum clearance requirement

Optimum airflow path and low noise operation

The stabilized airflow reduces the noise level significantly.

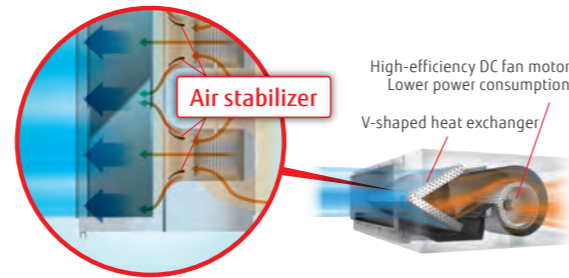

6-speed control*

Multistep airflow adjustment allows installation in a quiet location.

Low noise
20 dB(A)
at 04 model

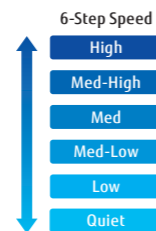

* Remote controller is compatible with the following:
UTY-RNRGZ5/UTY-RLRG/UTY-PSRG/UTY-RHRG/UTY-DCGGZ2/UTY-ALGXZ1/UTY-APQXZ1

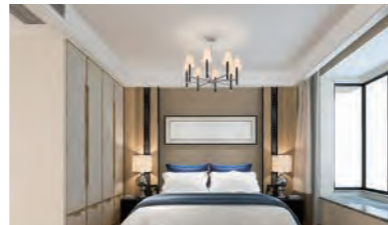

Easy to design and maintain for drain

Indoor unit design for easy maintenance. Parts can be replaced from the side of the unit where maintenance is easier.

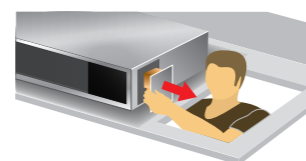

A drain pump is built into the unit as standard. Parts can be accessed and replaced through the side of the unit for easy maintenance.

Model: ARXK004GLGH / ARXK007GLGH / ARXK009GLGH
ARXK012GLGH / ARXK014GLGH / ARXK018GLGH
ARXK024GLGH

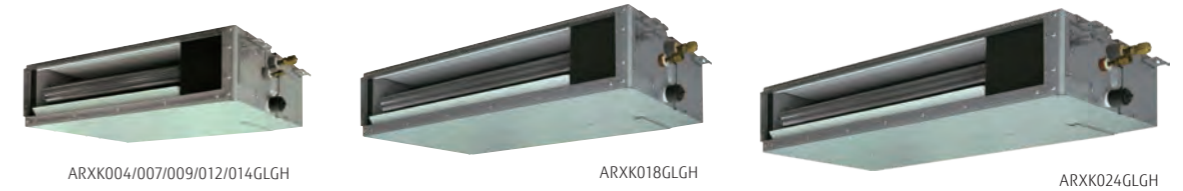

Specifications

| Model name | ARXK004GLGH | ARXK007GLGH | ARXK009GLGH | ARXK012GLGH | ARXK014GLGH | ARXK018GLGH | ARXK024GLGH |
|---------------------------------|-----------------------------|-----------------|-----------------|-----------------|-----------------|-----------------|-----------------|
| Power source | Single phase, ~230 V, 50 Hz | | | | | | |
| Capacity | Cooling | 1.1 | 2.2 | 2.8 | 3.6 | 4.5 | 7.1 |
| | Heating | 1.3 | 2.8 | 3.2 | 4.0 | 5.0 | 8.0 |
| Input power | W | 26 | 28 | 28 | 35 | 66 | 80 |
| Airflow rate | High | 460 | 460 | 460 | 550 | 760 | 1,160 |
| | Med-High | 440 | 440 | 440 | 520 | 660 | 1,060 |
| | Med | 420 | 420 | 420 | 480 | 560 | 960 |
| | Med-Low | 400 | 400 | 400 | 450 | 490 | 860 |
| | Low | 370 | 370 | 370 | 410 | 410 | 540 |
| Quiet | 340 | 340 | 340 | 340 | 340 | 470 | 610 |
| Static pressure range | Pa | 0 to 30 | 0 to 30 | 0 to 30 | 0 to 30 | 0 to 50 | 0 to 50 |
| Standard static pressure | | 10 | 10 | 10 | 10 | 15 | 15 |
| Sound pressure level | High | 25 | 26 | 26 | 29 | 34 | 32 |
| | Med-High | 24 | 25 | 25 | 27 | 31 | 30 |
| | Med | 23 | 24 | 24 | 26 | 28 | 28 |
| | Med-Low | 22 | 23 | 23 | 25 | 26 | 27 |
| | Low | 21 | 22 | 22 | 24 | 24 | 25 |
| Quiet | 20 | 21 | 21 | 22 | 22 | 22 | |
| Net Dimensions (H × W × D) | mm | 198 × 700 × 450 | 198 × 700 × 450 | 198 × 700 × 450 | 198 × 700 × 450 | 198 × 700 × 450 | 198 × 900 × 450 |
| Weight | kg | 14.5 | 15.5 | 15.5 | 16 | 16 | 19 |
| Connection pipe diameter | Liquid (Flare) | 6.35 | 6.35 | 6.35 | 6.35 | 6.35 | 9.52 |
| | Gas (Flare) | 9.52 | 9.52 | 9.52 | 12.70 | 12.70 | 15.88 |
| Drain Hose Diameter (I.D./O.D.) | | | | 25/32 | | | |

Note: Specifications are subject to the following conditions:
Cooling: Indoor temperature of 27°CDB/19°CWB, and outdoor temperature of 35°CDB/24°CWB.
Heating: Indoor temperature of 20°CDB/15°CWB, and outdoor temperature of 7°CDB/6°CWB.
Pipe length: 7.5 m; Height difference between outdoor unit and indoor unit: 0 m. Voltage: 230 [V].

Optional parts

*For more details, please refer to the chapter "Optional parts".

| | | | |
|---------------------|--|-----------------------------|--|
| Remote sensor unit: | UTY-XSZXZ1 | External power supply unit: | UTZ-GXXA, UTZ-GXXC* |
| IR receiver unit: | UTY-TRHX | Auto Louver Grille Kit: | UTD-GXTA-W (004-014) UTD-GXTB-W (018) UTD-GXTC-W (024) |
| Silver Ion Filter: | UTD-HFTA (004-014) UTD-HFTB (018) UTD-HFTC (024) | WLAN adapter: | FG-AC-WIF1Z1 UTY-TFSXJ3, UTY-TFSXZ1 (007-024) |

Auto Louver Grille Kit (Optional)

The slim design of the unit provides comfortable cooling and heating air conditioning over a wide area. The optional automatic louver grille, which fits nicely into any interior decor, provides comfortable air conditioning (Optional)



Dimensions

(Unit: mm)

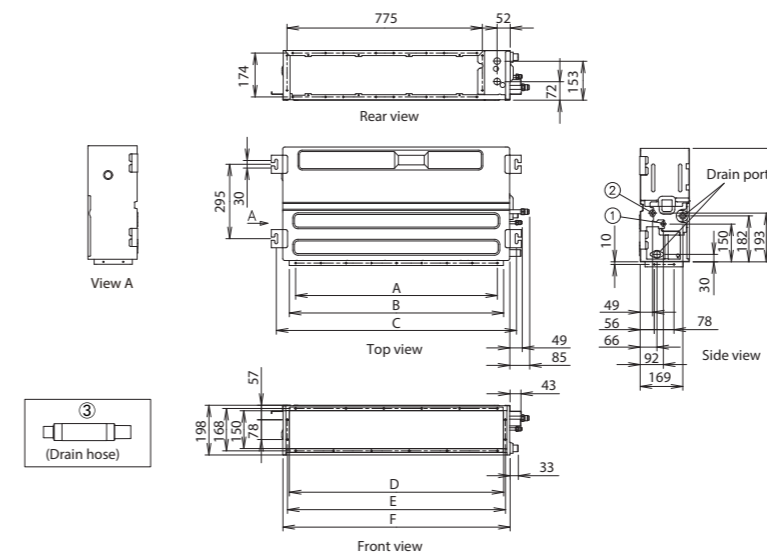

- ① Refrigerant pipe flare connection (Liquid)
- ② Refrigerant pipe flare connection (Gas)
- ③ Drain hose connection

| | ARXK004-014 | ARXK018 | ARXK024 |
|---|-------------|------------|--------------|
| A | P100×6=600 | P100×8=800 | P100×10=1000 |
| B | 650 | 850 | 1050 |
| C | 752 | 952 | 1152 |
| D | 650 | 850 | 1050 |
| E | 665 | 864 | 1064 |
| F | 700 | 900 | 1100 |

Low Static Pressure Duct Slim Duct/Slim Concealed Floor



Slim design

Slim design allows for installation in a tight ceiling space.

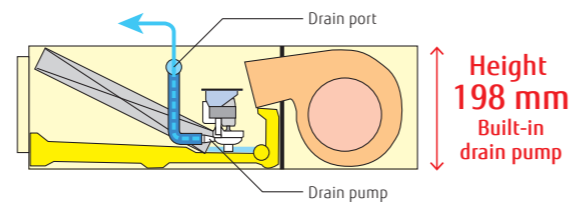

Air intake

Air intake direction can be selected to match the installation site.

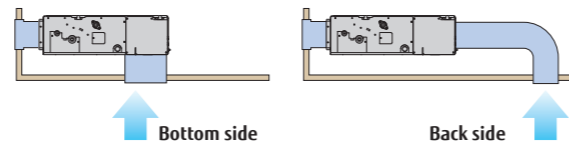

Flexible installation

Ceiling concealed

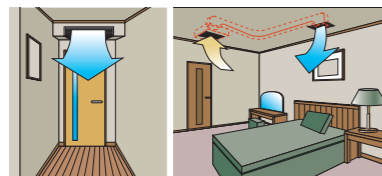

Floor concealed

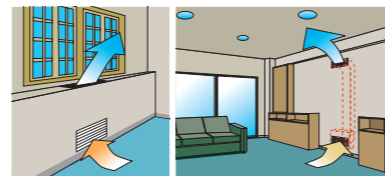

Wide range of static pressures

The use of a DC fan motor makes it possible to adjust the static pressure between 0 and 90 Pa. The static pressure range can be changed by a remote controller.



Static pressure range
0 to 90 Pa

*024 model static pressure range is 0 to 50 Pa.

Filter (Accessory)

ARXD04/007/009/012/014/018 ARXD024

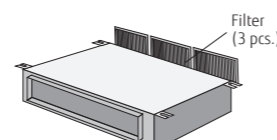
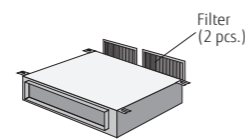

Model: ARXD04GALH / ARXD007GLEH / ARXD009GLEH
ARXD012GLEH / ARXD014GLEH / ARXD018GLEH
ARXD024GLEH



ARXD04GALH
ARXD007/009/012/014GLEH



ARXD018GLEH



ARXD024GLEH

Slim Concealed Floor



Specifications

| Model name | ARXD04GALH* | ARXD007GLEH | ARXD009GLEH | ARXD012GLEH | ARXD014GLEH | ARXD018GLEH | ARXD024GLEH | |
|---------------------------------|-----------------------------|-----------------|-----------------|-----------------|-----------------|-----------------|-----------------|--|
| Power source | Single phase, ~230 V, 50 Hz | | | | | | | |
| Capacity | Cooling | 1.1 | 2.2 | 2.8 | 3.6 | 4.5 | 7.1 | |
| | Heating | 1.3 | 2.8 | 3.2 | 4.0 | 5.0 | 8.0 | |
| Input power | W | 40 | 44 | 50 | 54 | 92 | 122 | |
| Airflow rate | High | 510 | 550 | 600 | 600 | 800 | 1,330 | |
| | Med-High | - | 480 | 510 | 530 | 680 | 1,140 | |
| | Med | 400/470*1 | 440 | 460 | 490 | 600 | 730 | |
| | Med-Low | - | 410 | 420 | 450 | 520 | 630 | |
| | Low | 320/440*1 | 370 | 370 | 410 | 440 | 540 | |
| Quiet | - | 320 | 320 | 340 | 340 | 470 | 610 | |
| Static pressure range | Pa | 0 to 90 | 0 to 90 | 0 to 90 | 0 to 90 | 0 to 90 | 0 to 50 | |
| Standard static pressure | | 25 | 25 | 25 | 25 | 25 | 25 | |
| Sound pressure level | High | 26 | 28 | 29 | 30 | 34 | 35 | |
| | Med-High | - | 26 | 27 | 28 | 32 | 31 | |
| | Med | 21/25*1 | 25 | 25 | 27 | 30 | 29 | |
| | Med-Low | - | 24 | 24 | 26 | 28 | 27 | |
| | Low | 20/22*1 | 22 | 22 | 24 | 25 | 24 | |
| Quiet | - | 21 | 21 | 22 | 22 | 23 | 21 | |
| Net Dimensions (H × W × D) | mm | 198 × 700 × 620 | 198 × 700 × 620 | 198 × 700 × 620 | 198 × 700 × 620 | 198 × 700 × 620 | 198 × 900 × 620 | |
| Weight | kg | 17 | 17 | 17 | 18 | 18 | 26 | |
| Connection pipe diameter | Liquid (Flare) | 6.35 | 6.35 | 6.35 | 6.35 | 6.35 | 9.52 | |
| | Gas (Flare) | 12.70 | 9.52 | 9.52 | 12.70 | 12.70 | 15.88 | |
| Drain Hose Diameter (I.D./O.D.) | | 25/32 | | | | | | |

Note: Specifications are subject to the following conditions:

Cooling: Indoor temperature of 27°CDB/19°CWB, and outdoor temperature of 35°CDB/24°CWB.

Heating: Indoor temperature of 20°CDB/15°CWB, and outdoor temperature of 7°CDB/6°CWB.

Pipe length: 7.5 m; Height difference between outdoor unit and indoor unit: 0 m. Voltage: 230 [V].

*1: This value is under cooling operation.

*: ARXD04GALH cannot be connected to J-IVS/J-IVJ-IVL/VR-IV Series.

Optional parts

*For more details, please refer to the chapter "Optional parts".

Remote sensor unit: UTY-XSZX21

External power supply unit: UTZ-GXXA, UTZ-GXXC*

IR receiver unit: UTB-YWC (04)

Auto Louver Grille Kit: UTD-GXTA-W (04, 007-014)

UTY-TRHX (007-024)

UTD-GXTB-W (018)

UTY-TFSXJ3 (007-024)

UTD-GXTC-W (024)

UTY-TFSXZ1 (007-024)

Silver Ion Filter: UTD-HFTA (04, 007-014)

FG-RC-WIF122 (04)

UTD-HFTB (018)

FG-AC-WIF121 (007-024)

UTD-HFTC (024)

Drain hose provided as an accessory.

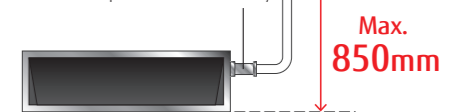

Dimensions

(Unit: mm)

*Maintenance accessibility should be considered when installing the product. Refer to the installation manual for the required maintenance access size.

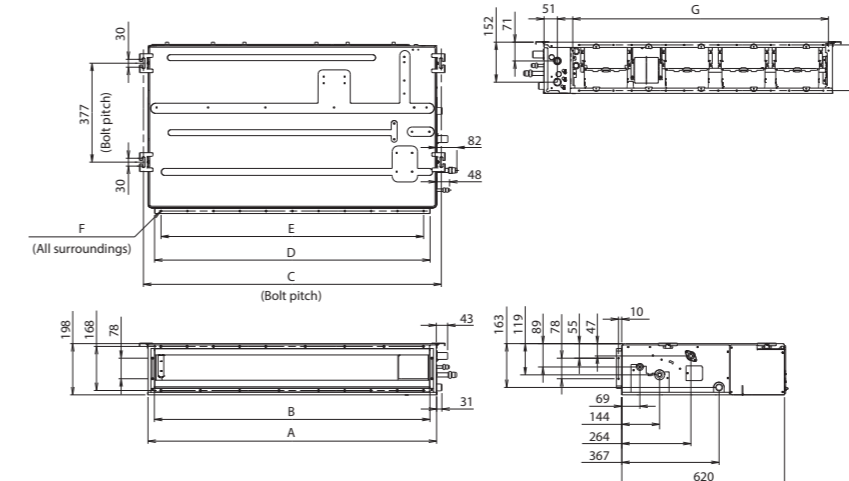

| | ARXD04-014 | ARXD018 | ARXD024 |
|---|----------------|----------------|------------------|
| A | 700 | 900 | 1100 |
| B | 650 | 850 | 1050 |
| C | 734 | 934 | 1134 |
| D | 650 | 850 | 1050 |
| E | P100 × 6 = 600 | P100 × 8 = 800 | P100 × 10 = 1000 |
| F | 18 × Ø5 | 22 × Ø5 | 26 × Ø5 |
| G | 574 | 774 | 974 |

Low static pressure duct High Efficiency



Slim & Compact design

The slim and compact design of the indoor unit, with the control box mounted on the side, allows installation in narrow spaces.

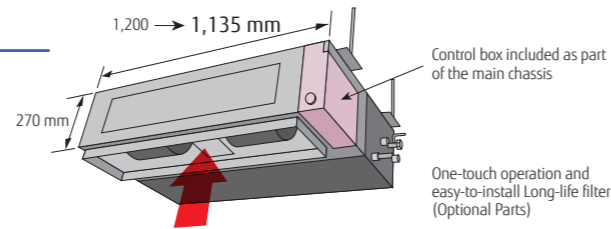

Easy maintenance

Structural improvement has been developed by making the bottom panel in two pieces, front and rear. The internal fan casing is also manufactured in two pieces—upper and lower. The motor and fan can be easily accessed and maintained by removing the rear panel and the lower casing with the main chassis remaining in place.

See below for rear-suction type

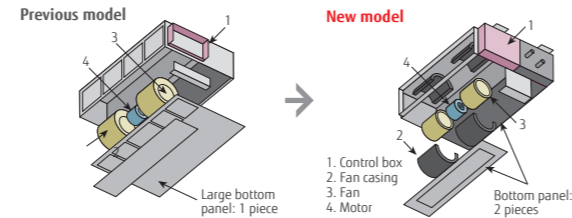

Installation styles

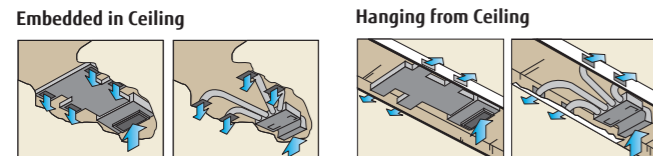

A drain pipe can be installed on either the left or right side of the unit

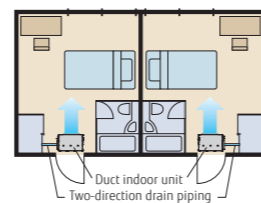

High-efficiency DC fan motor achieves low-energy consumption.

Improved motor efficiency from previous model.

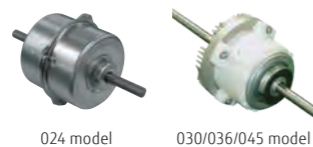

Wide range of static pressures

Static pressures can be changed in the range of 0 to 150 Pa.

Static pressure range
0 to 80 Pa

Model: ARXP018GLFH / ARXP030GLFH * Production by order

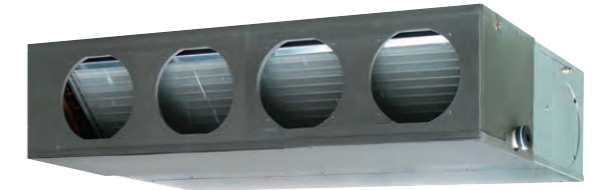

Specifications

| Model name | | ARXP018GLFH | ARXP030GLFH |
|---------------------------------|----------------|---------------------------|-------------------|
| Power source | | Single-phase, ~220V, 50Hz | |
| Capacity | Cooling | 5.6 | 9.0 |
| | Heating | 6.3 | 10.0 |
| Input power | | 128 | 228 |
| Airflow rate | High | 1,540 / 1,440 | 1,940 / 1,660 |
| | Med-High | 1,460 / 1,380 | 1,810 / 1,580 |
| | Med | 1,380 / 1,320 | 1,680 / 1,510 |
| | Med-Low | 1,300 / 1,260 | 1,550 / 1,440 |
| | Low | 1,220 / 1,200 | 1,420 / 1,370 |
| Quiet | | 1,150 / 1,150 | 1,300 / 1,300 |
| Static pressure range | | 0 to 80 | |
| Standard static pressure | | 40 | 50 |
| Sound pressure level | High | 35 / 34 | 39 / 36 |
| | Med-High | 34 / 32 | 38 / 35 |
| | Med | 32 / 31 | 36 / 34 |
| | Med-Low | 31 / 30 | 34 / 33 |
| | Low | 29 / 29 | 32 / 31 |
| Quiet | | 28 / 28 | 30 / 30 |
| Net Dimensions (H × W × D) | | 270 × 1,135 × 700 | 270 × 1,135 × 700 |
| Weight | | 40 | 40 |
| Connection pipe diameter | Liquid (Flare) | 6.35 | 9.52 |
| | Gas (Flare) | 12.70 | 15.88 |
| Drain Hose Diameter (I.D./O.D.) | | 25/32 | |

Note: Specifications are subject to the following conditions:
Cooling: Indoor temperature of 27°CDB/19°CWB, and outdoor temperature of 35°CDB/24°CWB.
Heating: Indoor temperature of 20°CDB/15°CWB, and outdoor temperature of 7°CDB/6°CWB.
Pipe length: 7.5 m; Height difference between outdoor unit and indoor unit: 0 m. Voltage: 230 [V].

Optional parts

*For more details, please refer to the chapter "Optional parts."

| | | | |
|-----------------------------|---------------------|--------------------|--------------------------------------|
| Long-life filter: | UTD-LF25NA | IR receiver unit: | UTY-TRHX |
| Flange (square): | UTD-SF045T | Drain pump unit: | UTZ-PX1NBA |
| Flange (round): | UTD-RF204 | WLAN adapter: | UTY-TFSXZ1, UTY-TFSXJ3, FG-AC-WIF1Z1 |
| External power supply unit: | UTZ-GXXA, UTZ-GXXC* | Silver Ion Filter: | UTD-HFND |
| Remote sensor unit: | UTY-XSZXZ1 | | |

Dimensions

(Unit: mm)

*Maintenance accessibility should be considered when installing the product. Refer to the installation manual for the required maintenance access size.

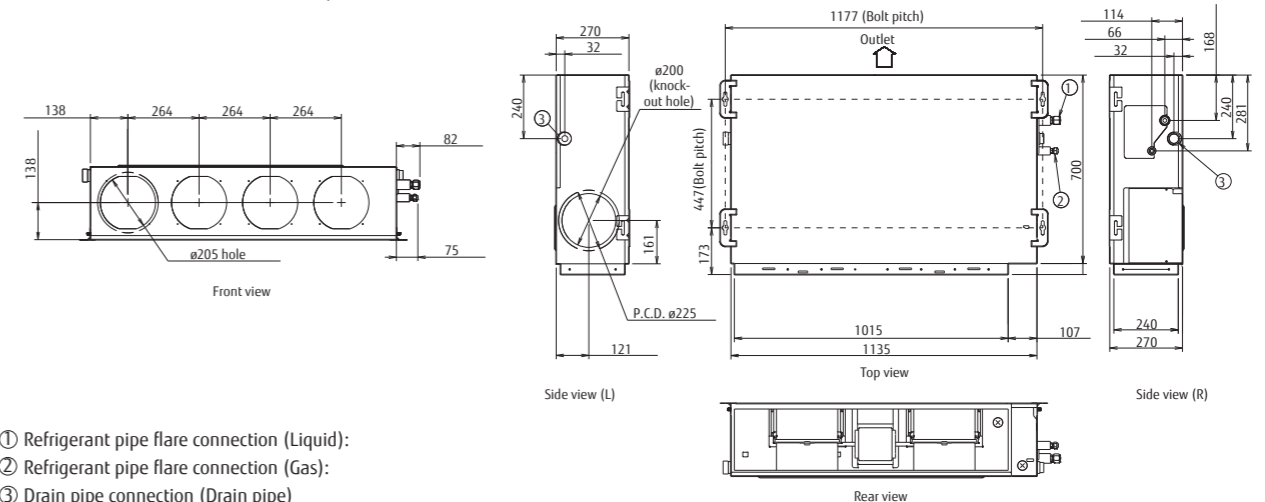

- ① Refrigerant pipe flare connection (Liquid):
- ② Refrigerant pipe flare connection (Gas):
- ③ Drain pipe connection (Drain pipe)

Medium static pressure duct Normal



Slim & Compact design

The slim and compact design of the indoor unit, with the control box mounted on the side, allows installation in narrow spaces.

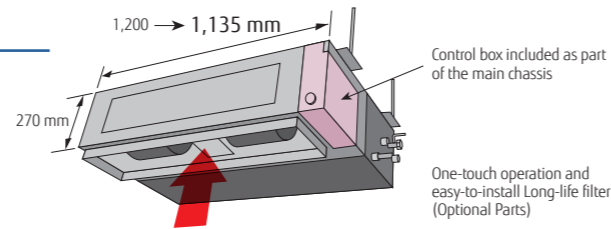

Easy maintenance

Structural improvement has been developed by making the bottom panel in two pieces, front and rear. The internal fan casing is also manufactured in two pieces—upper and lower. The motor and fan can be easily accessed and maintained by removing the rear panel and the lower casing with the main chassis remaining in place.

See below for rear-suction type

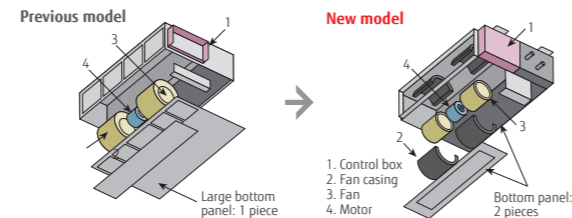

Installation styles

Embedded in Ceiling

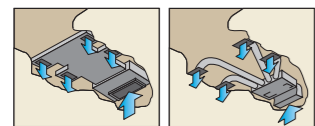

Hanging from Ceiling

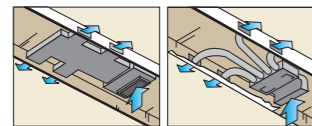

A drain pipe can be installed on either the left or right side of the unit

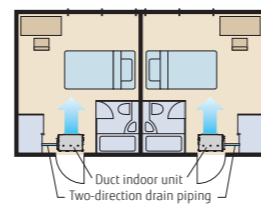

High-efficiency DC fan motor achieves low-energy consumption.

Improved motor efficiency from previous model.

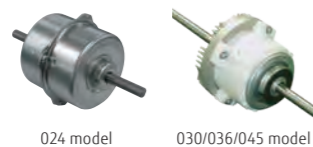

Wide range of static pressures

Static pressures can be changed in the range of 0 to 150 Pa.

Static pressure range
0 to 150 Pa

Model: ARXA024GLEH / ARXA030GLEH / ARXA036GLEH / ARXA045GLEH

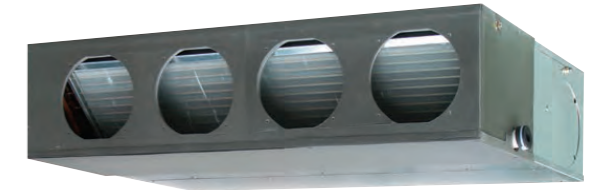

Specifications

| Model name | | | ARXA024GLEH | ARXA030GLEH | ARXA036GLEH | ARXA045GLEH |
|---------------------------------|----------------|-------------------|-----------------------------|-------------------|-------------------|-------------------|
| Power source | | | Single phase, ~230 V, 50 Hz | | | |
| Capacity | Cooling | kW | 7.1 | 9.0 | 11.2 | 12.5 |
| | Heating | | 8.0 | 10.0 | 12.5 | 14.0 |
| Input power | W | | 94 | 108 | 194 | 240 |
| Airflow rate | High | m ³ /h | 1,280 | 1,410 | 1,840 | 1,970 |
| | Med-High | | 1,180 | 1,350 | 1,750 | 1,910 |
| | Med | | 1,090 | 1,280 | 1,660 | 1,860 |
| | Med-Low | | 1,000 | 1,240 | 1,600 | 1,780 |
| | Low | | 920 | 1,190 | 1,530 | 1,710 |
| Quiet | | 840 | 1,150 | 1,470 | 1,640 | |
| Static pressure range | Pa | | 0 to 150 | 0 to 150 | 0 to 150 | 0 to 150 |
| Standard static pressure | | | 40 | 50 | 50 | 60 |
| Sound pressure level | High | dB(A) | 31 | 34 | 37 | 41 |
| | Med-High | | 29 | 33 | 36 | 40 |
| | Med | | 27 | 32 | 35 | 38 |
| | Med-Low | | 26 | 31 | 35 | 38 |
| | Low | | 24 | 30 | 34 | 37 |
| Quiet | | 23 | 29 | 33 | 36 | |
| Net Dimensions (H × W × D) | mm | | 270 × 1,135 × 700 | 270 × 1,135 × 700 | 270 × 1,135 × 700 | 270 × 1,135 × 700 |
| Weight | kg | | 36 | 40 | 40 | 40 |
| Connection pipe diameter | Liquid (Flare) | mm | 9.52 | 9.52 | 9.52 | 9.52 |
| | Gas (Flare) | | 15.88 | 15.88 | 15.88 | 15.88 |
| Drain Hose Diameter (I.D./O.D.) | | | 25/32 | | | |

Note: Specifications are subject to the following conditions:
Cooling: Indoor temperature of 27°CDB/19°CWB, and outdoor temperature of 35°CDB/24°CWB.
Heating: Indoor temperature of 20°CDB/15°CWB, and outdoor temperature of 7°CDB/6°CWB.
Pipe length: 7.5 m; Height difference between outdoor unit and indoor unit: 0 m. Voltage: 230 [V].

Optional parts

*For more details, please refer to the chapter "Optional parts".

- Long-life filter: UTD-LF25NA
- Flange (square): UTD-SF045T
- Flange (round): UTD-RF204
- External power supply unit: UTZ-GXXA, UTZ-GXXC*
- Remote sensor unit: UTY-XSZXZ1
- IR receiver unit: UTY-TRHX
- Drain pump unit: UTZ-PX1NBA
- WLAN adapter: UTY-TFSXZ1, UTY-TFSXJ3, FG-AC-WIF1Z1
- Silver Ion Filter: UTD-HFND

Dimensions

(Unit: mm)

*Maintenance accessibility should be considered when installing the product. Refer to the installation manual for the required maintenance access size.

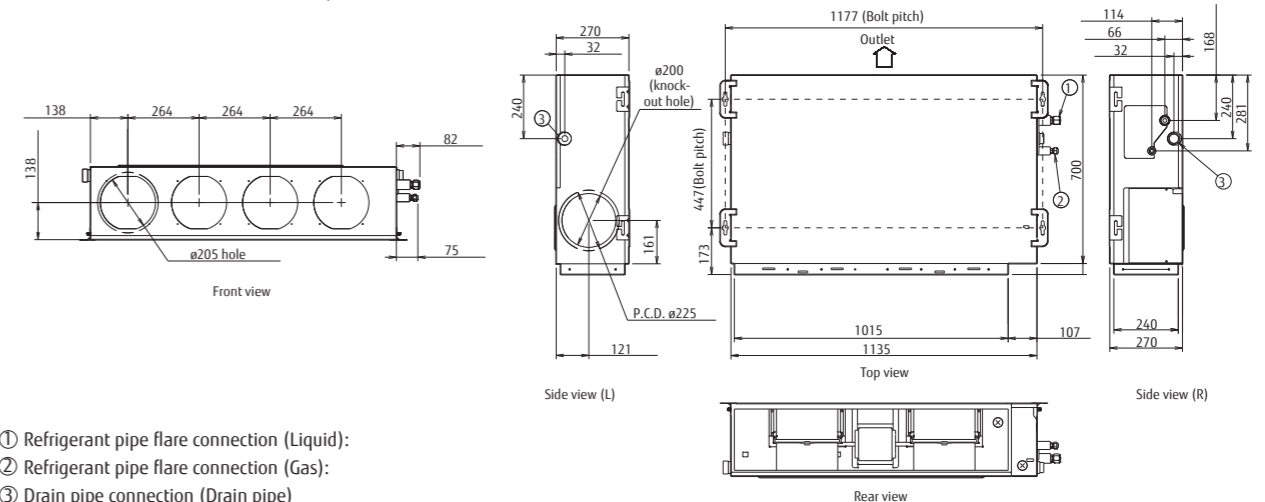

- ① Refrigerant pipe flare connection (Liquid):
- ② Refrigerant pipe flare connection (Gas):
- ③ Drain pipe connection (Drain pipe)

High Static Pressure Duct Normal



Model: ARXC036GTEH / ARXC045GTEH / ARXC060GTEH
ARXC072GTEH / ARXC090GTEH / ARXC096GTEH



ARXC036/045/060GTEH



ARXC072/090GTEH



ARXC096GTEH

Static pressure mode selection

The use of a DC fan motor makes it possible to adjust the static pressure between 0 to 200 Pa (ARXC036) / 250Pa (ARXC045/060) / 300 Pa (ARXC072/090/096)

MAX. 200 Pa (036 type)



(ARXC036/045/060 type)

MAX. 250 Pa (045/060 type)



(ARXC072/090 type)

MAX. 300 Pa



(ARXC096 type)

MAX. 300 Pa

Easy installation (Compact & Lightweight)

The indoor unit is designed to be compact and light by reducing the basic chassis size and the overall material weight.

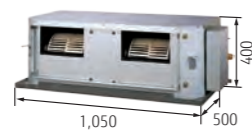

(ARXC036/045/060 type)

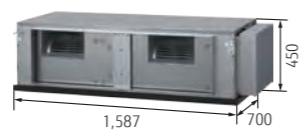

(ARXC072/090 type)



(ARXC096 type)

(Unit: mm)

Low noise

Models: ARXC036/ARXC045/ARXC060

The corners of the front panel and fan casing of the indoor unit are shaved to reduce air turbulence. The use of a plastic case and fan reduces the noise level generated by the unit.

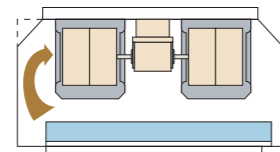

ARXC036GTEH: Plastic fan [42 dB(A)]

* Model: Material (Actual noise measurement value measured at 100 Pa)

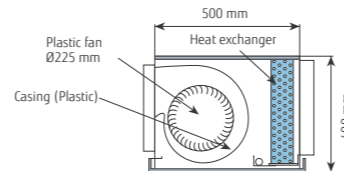

High-efficiency DC fan motor achieves low energy consumption.

Improved motor efficiency compared to the previous model



(ARXC036/045/060 type)



(ARXC072/090/096 type)

Specifications

| Model name | ARXC036GTEH | ARXC045GTEH | ARXC060GTEH* | ARXC072GTEH* | ARXC090GTEH* | ARXC096GTEH* |
|---------------------------------|-----------------------------|-------------------|-------------------|-------------------|-------------------|-------------------|
| Power source | Single phase, ~230 V, 50 Hz | | | | | |
| Capacity | Cooling | 11.2 | 12.5 | 18.0 | 22.4 | 28.0 |
| | Heating | 12.5 | 14.0 | 20.0 | 25.0 | 31.5 |
| Input power | W | 207 | 715 | 730 | 681 | 838 |
| | kW | 1.990 | 3.500 | 3.500 | 3.900 | 4.850 |
| Airflow rate | High | 1,990 | 3,000 | 3,000 | 3,300 | 4,000 |
| | Med | 1,680 | 2,460 | 2,460 | 3,000 | 3,500 |
| | Low | 1,330 | 2,460 | 2,460 | 3,000 | 3,600 |
| Static pressure range | Pa | 0 to 200 | 100 to 250 | 100 to 250 | 0 to 300 | 0 to 300 |
| Standard static pressure | Pa | 100 | 100 | 100 | 150 | 150 |
| | dB(A) | 42 | 49 | 49 | 47 | 48 |
| Sound pressure level | High | 36 | 45 | 45 | 43 | 46 |
| | Med | 32 | 42 | 42 | 40 | 44 |
| | Low | 32 | 42 | 42 | 40 | 44 |
| Net Dimensions (H x W x D) | mm | 400 x 1,050 x 500 | 400 x 1,050 x 500 | 400 x 1,050 x 500 | 450 x 1,587 x 700 | 450 x 1,587 x 700 |
| Weight | kg | 40 | 46 | 46 | 84 | 105 |
| Connection pipe diameter | Liquid | 9.52 (Flare) | 9.52 (Flare) | 9.52 (Flare) | 9.52 (Flare) | 9.52 (Flare) |
| | Gas | 15.88 (Flare) | 15.88 (Flare) | 15.88 (Flare) | 19.05 (Flare) | 19.05 (Flare) |
| Drain Hose Diameter (I.D./O.D.) | 25/32 | | | | | |

Note: Specifications are based on the following conditions:
Cooling: Indoor temperature of 27°CDB/19°CWB, and outdoor temperature of 35°CDB/24°CWB.
Heating: Indoor temperature of 20°CDB/15°CWB, and outdoor temperature of 7°CDB/6°CWB.
Pipe length: 7.5 m; Height difference between outdoor unit and indoor unit: 0 m. Voltage: 230 [V]
*: ARXC060/072/090/096G cannot be connected to J-IVJ-IVS Series.

Optional parts

- Long-life filter: UTD-LF60KA (036/045/060)
- IR receiver unit: UTY-TRHX
- External power supply unit: UTZ-GXXA, UTZ-GXXC*
- WLAN adapter: UTY-TFSXZ1, UTY-TFSXJ3, FG-AC-WIF1Z1
- Silver Ion Filter: UTD-HFKB (036/045/060)
- Remote sensor unit: UTY-XSZXZ1

Dimensions

(Unit: mm)

Models: ARXC036/ARXC045/ARXC060

Models: ARXC072/ARXC090

Models: ARXC096

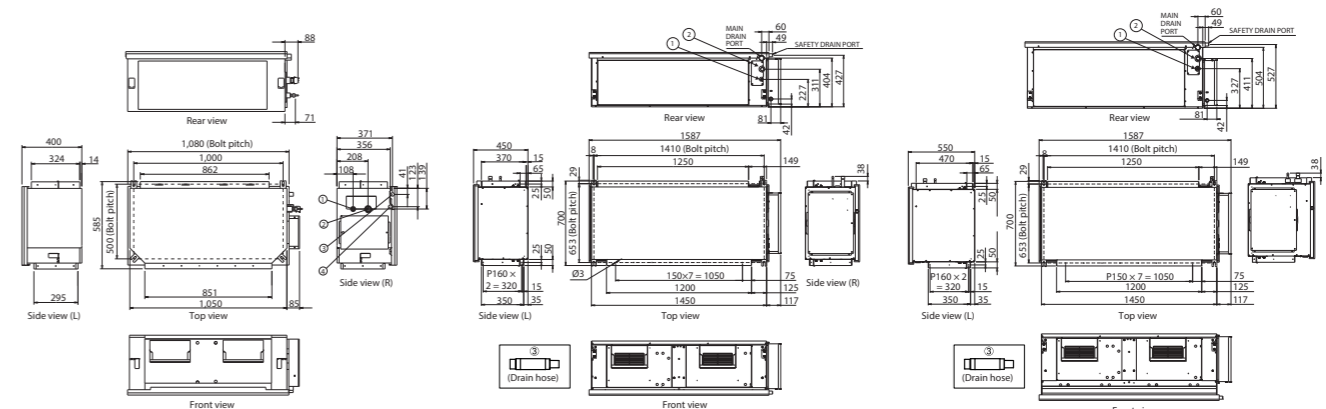

- ① Refrigerant pipe flare connection (Liquid)
- ② Refrigerant pipe flare connection (Gas)
- ③ Drain pipe connection (Safety drain pan)
- ④ Drain pipe connection (Main drain pan)

- ① Refrigerant pipe flare connection (Liquid)
- ② Refrigerant pipe flare connection (Gas)
- ③ Drain hose

- ① Refrigerant pipe flare connection (Liquid)
- ② Refrigerant pipe flare connection (Gas)
- ③ Drain hose

Compact floor



2-fan and wide airflow

A 2-fan individual vertical airflow cools or warms the entire room comfortably.

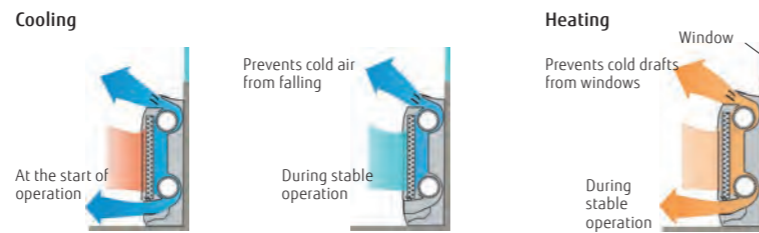

Flexible and easy installation

The compact and whole-surface suction design provides flexible installation options, including floor-standing, partially embedded, and wall-mounted installation to match the room layout.

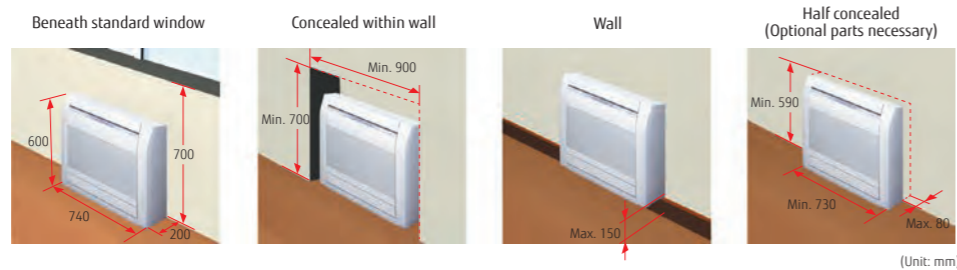

Quiet operation

6-fan speed control for quiet operation (via 2-wire controller)

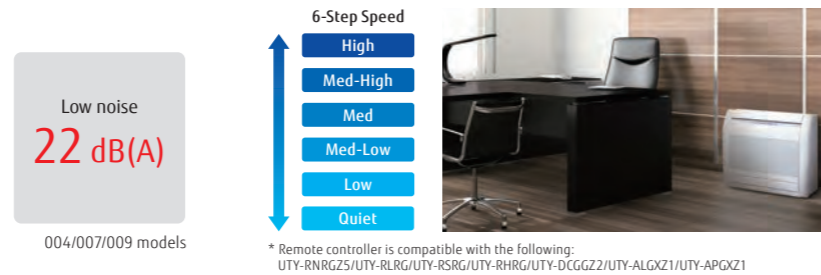

Flexible pipe connection enables draining and piping in 6 directions

The drain hose and pipe can be connected to the unit in the right, left, straight in depth, or downward direction.

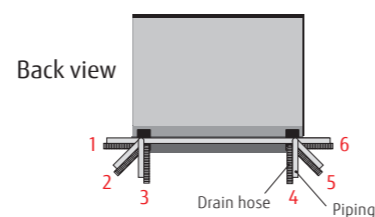

Model: AGHA004GCGH / AGHA007GCGH / AGHA009GCGH
 AGHA012GCGH / AGHA014GCGH
 [external EEV]
 AGHE004GCEH / AGHE007GCEH / AGHE009GCEH
 AGHE012GCEH / AGHE014GCEH



Specifications

| Model name | | AGHA004GCGH | AGHA007GCGH | AGHA009GCGH | AGHA012GCGH | AGHA014GCGH | AGHE004GCEH | AGHE007GCEH | AGHE009GCEH | AGHE012GCEH | AGHE014GCEH | |
|---------------------------------|----------------|-----------------------------------|-------------|-------------|-------------|-------------|-------------|-----------------------------------|-------------|-------------|-------------|--|
| Power source | | Single phase, ~230 V, 50 Hz | | | | | | Single phase, ~230 V, 50 Hz | | | | |
| Capacity | Cooling | 1.1 | 2.2 | 2.8 | 3.6 | 4.0 | 1.1 | 2.2 | 2.8 | 3.6 | 4.0 | |
| | Heating | 1.3 | 2.8 | 3.2 | 4.0 | 4.5 | 1.3 | 2.8 | 3.2 | 4.0 | 4.5 | |
| Input power | | W | | | | | | W | | | | |
| Airflow rate | High | 380/430 | 470 | 500 | 590 | 670 | 380/430 | 470 | 500 | 590 | 670 | |
| | Med-High | 350 | 420 | 450 | 520 | 590 | 350 | 420 | 450 | 520 | 590 | |
| | Med | 320 | 390 | 400 | 470 | 520 | 320 | 390 | 400 | 470 | 520 | |
| | Med-Low | 310 | 360 | 360 | 420 | 450 | 310 | 360 | 360 | 420 | 450 | |
| | Low | 280 | 330 | 330 | 390 | 390 | 280 | 330 | 330 | 390 | 390 | |
| Sound pressure level | High | 35/36 | 37 | 38 | 42 | 46 | 35/36 | 37 | 38 | 42 | 46 | |
| | Med-High | 33 | 35 | 36 | 39 | 42 | 33 | 35 | 36 | 39 | 42 | |
| | Med | 31 | 33 | 34 | 37 | 39 | 31 | 33 | 34 | 37 | 39 | |
| | Med-Low | 30 | 31 | 31 | 35 | 36 | 30 | 31 | 31 | 35 | 36 | |
| | Low | 28 | 29 | 29 | 33 | 33 | 28 | 29 | 29 | 33 | 33 | |
| Quiet | 22 | 22 | 22 | 30 | 30 | 22 | 22 | 22 | 30 | 30 | | |
| Net Dimensions (H × W × D) | | mm 600 × 740 × 200 | | | | | | mm 600 × 740 × 200 | | | | |
| Weight | | kg 15.0, 15.0, 15.0, 15.0, 15.0 | | | | | | kg 14.5, 14.5, 14.5, 14.5, 14.5 | | | | |
| Connection pipe diameter | Liquid (Flare) | mm 6.35, 6.35, 6.35, 6.35, 6.35 | | | | | | mm 6.35, 6.35, 6.35, 6.35, 6.35 | | | | |
| | Gas (Flare) | mm 9.52, 9.52, 9.52, 12.70, 12.70 | | | | | | mm 9.52, 9.52, 9.52, 12.70, 12.70 | | | | |
| Drain Hose Diameter (I.D./O.D.) | | mm 13.8/15.8 to 16.7 | | | | | | mm 13.8/15.8 to 16.7 | | | | |
| EV kit (optional) | | | | | | | | UTR-EV09XB | | UTR-EV14XB | | |

Note: Specifications are subject to the following conditions:
 Cooling: Indoor temperature of 27°CDB/19°CWB, and outdoor temperature of 35°CDB/24°CWB.
 Heating: Indoor temperature of 20°CDB/15°CWB, and outdoor temperature of 7°CDB/6°CWB.
 Pipe length: 7.5 m; Height difference between outdoor unit and indoor unit: 0 m. Voltage: 230 [V]
 When connecting AGHA004/007/009GCGH, AGHE004/007/009GCEH to an outdoor unit other than an outdoor unit of the J-IVL Series, the gas pipe diameter should be Ø12.70 mm.

Optional parts

- Partially concealing kit: UTR-STA
- External power supply unit: UTZ-GXXA, UTZ-GXXC*
- WLAN adapter: UTY-TFSXZ1, UTY-TFSXJ3, FG-AC-WIF1Z1
- Silver Ion Filter: UTR-FA03-5

Dimensions

(Unit: mm)

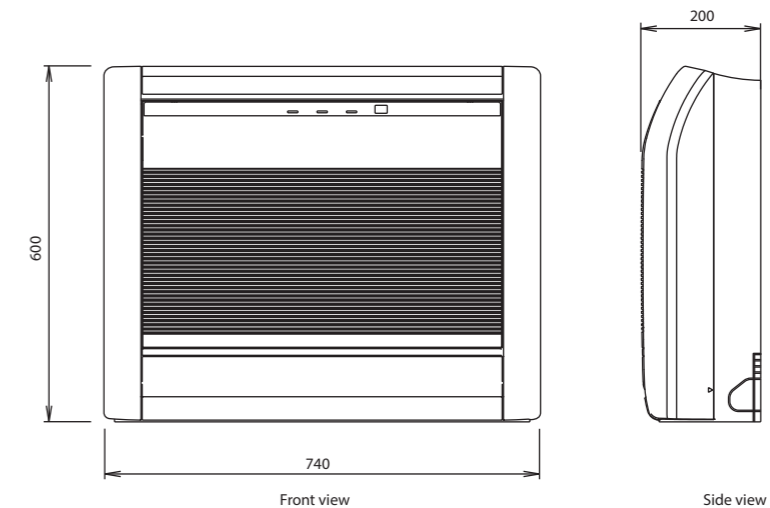

Floor/Ceiling



Flexible installation

Example of floor standing installation

Floor standing console with the back against the wall



Example of ceiling installation

Under ceiling



Double auto swing

The combination of horizontal and vertical swings enables 3-dimensional control of the airflow direction.

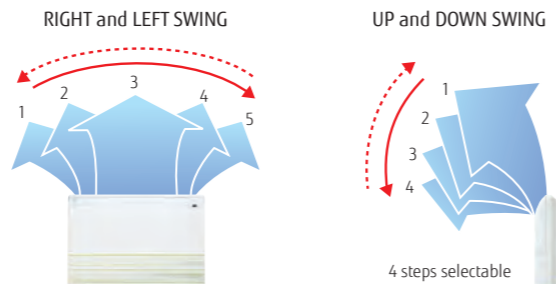

High-power DC fan motor

- High power
- Wide rotation range
- High-efficiency



Compact design

Symmetrical, slim and compact design.

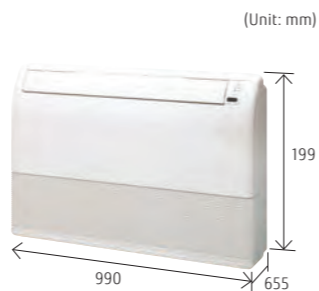

Model: ABHA012GTEH / ABHA014GTEH / ABHA018GTEH / ABHA024GTEH

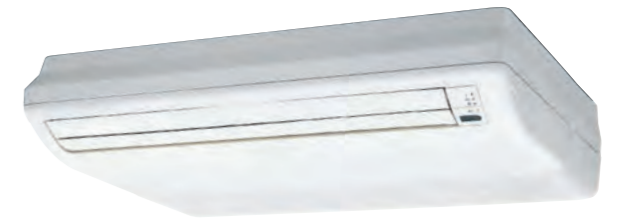

Specifications

| Model name | | ABHA012GTEH | ABHA014GTEH | ABHA018GTEH | ABHA024GTEH |
|---------------------------------|----------------|-----------------------------|--------------------|--------------------|--------------------|
| Power source | | Single phase, ~230 V, 50 Hz | | | |
| Capacity | Cooling | 3.6 | 4.5 | 5.6 | 7.1 |
| | Heating | 4.0 | 5.0 | 6.3 | 8.0 |
| Input power | | 30 | 42 | 74 | 99 |
| Airflow rate | High | 660 | 780 | 1,000 | 1,000 |
| | Med-High | 620 | 740 | 910 | 930 |
| | Med | 580 | 690 | 830 | 870 |
| | Med-Low | 550 | 640 | 750 | 800 |
| | Low | 520 | 600 | 660 | 740 |
| | Quiet | 490 | 550 | 580 | 680 |
| Sound pressure level | High | 36 | 40 | 46 | 47 |
| | Med-High | 34 | 39 | 44 | 45 |
| | Med | 33 | 38 | 42 | 43 |
| | Med-Low | 31 | 36 | 40 | 41 |
| | Low | 29 | 35 | 37 | 39 |
| | Quiet | 28 | 34 | 35 | 37 |
| Net Dimensions (H × W × D) | | mm 199 × 990 × 655 | mm 199 × 990 × 655 | mm 199 × 990 × 655 | mm 199 × 990 × 655 |
| Weight | | kg 25 | kg 26 | kg 26 | kg 27 |
| Connection pipe diameter | Liquid (Flare) | 6.35 | 6.35 | 6.35 | 9.52 |
| | Gas (Flare) | 12.70 | 12.70 | 12.70 | 15.88 |
| Drain Hose Diameter (I.D./O.D.) | | 25/32 | | | |

Note: Specifications are subject to the following conditions:
 Cooling: Indoor temperature of 27°CDB/19°CWB, and outdoor temperature of 35°CDB/24°CWB.
 Heating: Indoor temperature of 20°CDB/15°CWB, and outdoor temperature of 7°CDB/6°CWB.
 Pipe length: 7.5 m; Height difference between outdoor unit and indoor unit: 0 m. Voltage: 230 [V]

Optional parts

*For more details, please refer to the chapter "Optional parts".

- External power supply unit: UTZ-GXXA, UTZ-GXXC*
 WLAN adapter: UTY-TFSXZ1, UTY-TFSXJ3, FG-AC-WIF1Z1

Dimensions

(Unit: mm)

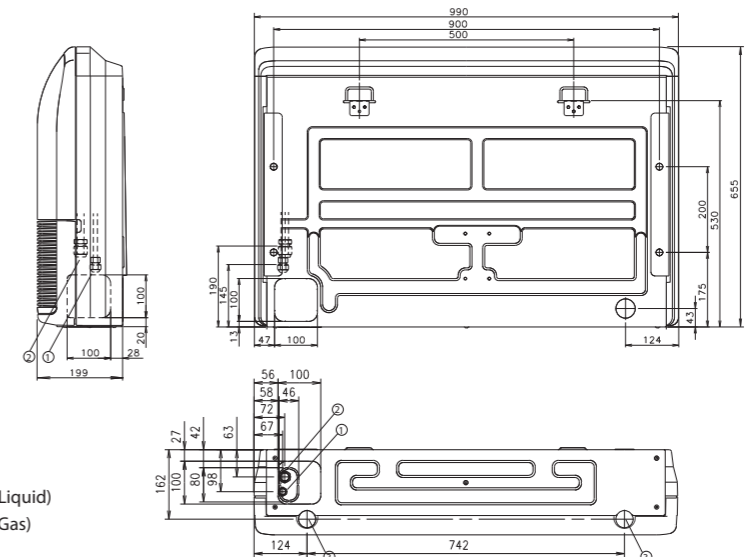

- ① Refrigerant pipe flare connection (Liquid)
- ② Refrigerant pipe flare connection (Gas)
- ③ Drain pipe connection

Ceiling



Installation

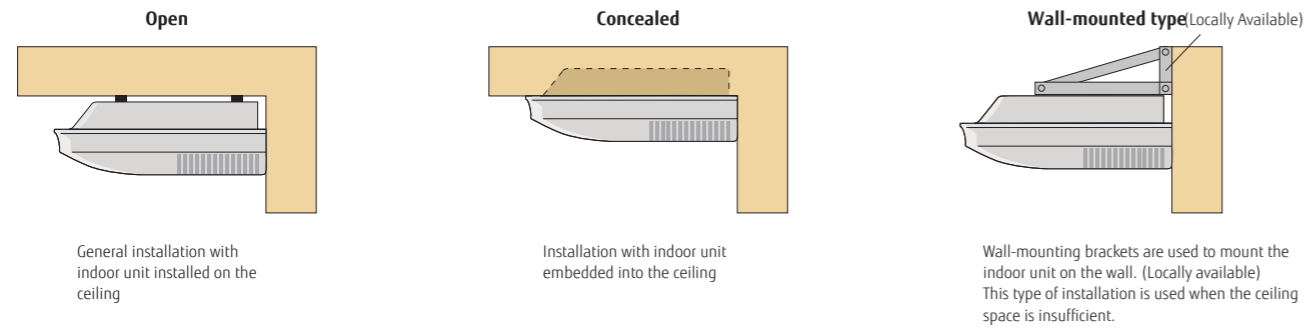

Double auto swing and wide airflow

Auto airflow direction and auto swing

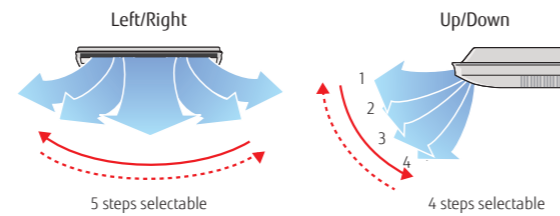

High-power DC fan motor

- High power
- Wide rotation range
- High-efficiency

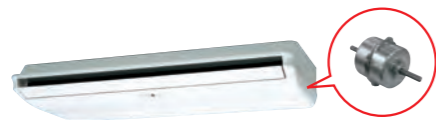

Long airflow

Long airflow provides comfort in every corner of a large room.

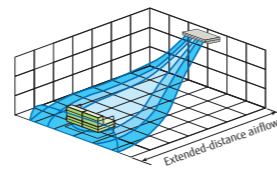

Fresh air intake

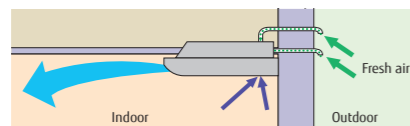

Slim & Compact design



Model: ABHA030GTEH / ABHA036GTEH / ABHA045GTEH / ABHA054GTEH



Specifications

| Model name | | ABHA030GTEH | ABHA036GTEH | ABHA045GTEH | ABHA054GTEH |
|---------------------------------|----------------|-----------------------------|-------------------|-------------------|-------------------|
| Power source | | Single phase, ~230 V, 50 Hz | | | |
| Capacity | Cooling | 9.0 | 11.2 | 12.5 | 14.0 |
| | Heating | 10.0 | 12.5 | 14.0 | 16.0 |
| Input power | | 66 | 85 | 131 | 180 |
| Airflow rate | High | 1,630 | 1,690 | 2,010 | 2,270 |
| | Med-High | 1,520 | 1,560 | 1,840 | 2,070 |
| | Med | 1,420 | 1,450 | 1,690 | 1,860 |
| | Med-Low | 1,320 | 1,360 | 1,530 | 1,660 |
| | Low | 1,220 | 1,270 | 1,380 | 1,470 |
| | Quiet | 1,140 | 1,170 | 1,230 | 1,280 |
| Sound pressure level | High | 42 | 45 | 48 | 51 |
| | Med-High | 40 | 41 | 46 | 49 |
| | Med | 39 | 39 | 45 | 46 |
| | Med-Low | 37 | 38 | 41 | 43 |
| | Low | 35 | 36 | 38 | 40 |
| | Quiet | 33 | 34 | 35 | 36 |
| Net Dimensions (H × W × D) | | mm 240 × 1,660 × 700 | 240 × 1,660 × 700 | 240 × 1,660 × 700 | 240 × 1,660 × 700 |
| Weight | | kg 46 | 48 | 48 | 48 |
| Connection pipe diameter | Liquid (Flare) | 9.52 | 9.52 | 9.52 | 9.52 |
| | Gas (Flare) | 15.88 | 15.88 | 15.88 | 15.88 |
| Drain Hose Diameter (I.D./O.D.) | | 25/32 | | | |

Note: Specifications are subject to the following conditions:
Cooling: Indoor temperature of 27°CDB/19°CWB, and outdoor temperature of 35°CDB/24°CWB.
Heating: Indoor temperature of 20°CDB/15°CWB, and outdoor temperature of 7°CDB/6°CWB.
Pipe length: 7.5 m; Height difference between outdoor unit and indoor unit: 0 m. Voltage: 230 [V]

Optional parts

- Drain pump unit: UTR-DPB24T
- Flange: UTD-RF204
- External power supply unit: UTZ-GXXA, UTZ-GXXC*
- WLAN adapter: UTY-TFSXZ1, UTY-TFSXJ3, FG-AC-WIF1Z1

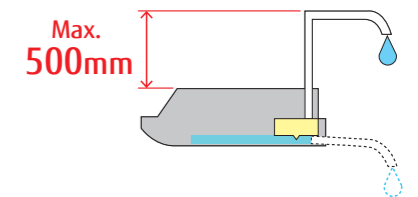

Dimensions

(Unit: mm)

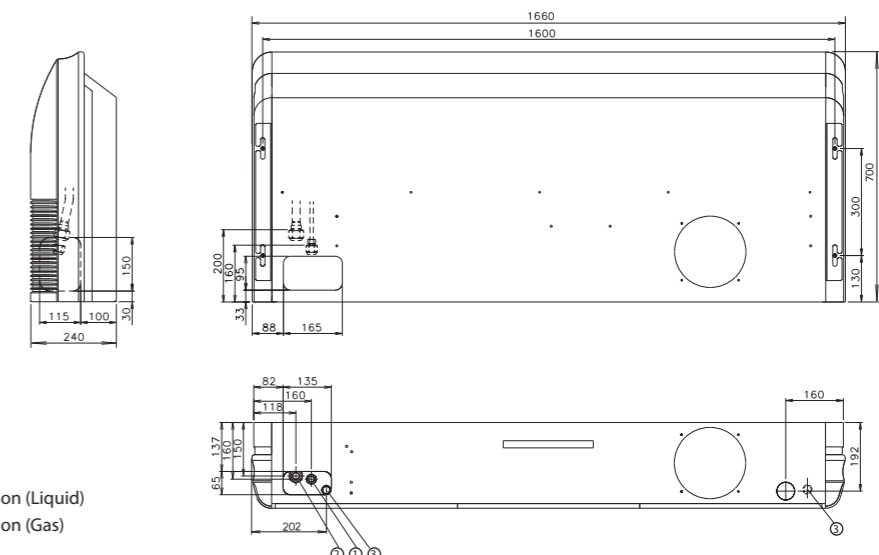

- ① Refrigerant pipe flare connection (Liquid)
- ② Refrigerant pipe flare connection (Gas)
- ③ Drain pipe connection

Wall-mounted type



Highly-efficiency, compact design

The 004-014 models share the same design. The high-density and large heat exchanger achieves a highly-efficiency and compact design. The compact body blends in well with conference rooms and offices, providing comfortable air conditioning.

High-density heat exchanger

Slim tube design: 5 mm
Greater heat-exchanging capacity is achieved through the use of a high-density heat exchanger and a sub-heat exchanger.

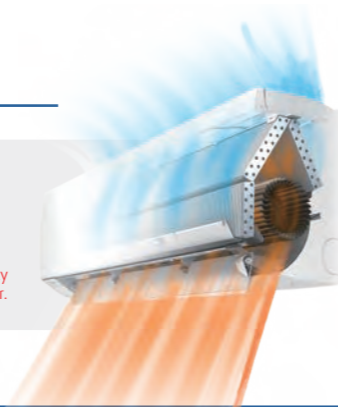

More comfortable airflow

The unique power diffuser provides comfortable air conditioning.

Heating

The vertical airflow provides powerful floor-level heating.

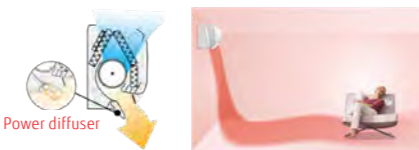

Cooling

The left/right airflow avoids blowing cool air directly at the occupants in a room.



Quiet operation & 6-Step fan speed control

The airflow pattern achieves significant noise reduction. Multistep airflow adjustment to suit the environment

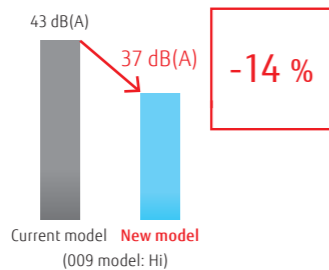

- 6-Step Speed
- High
- Med-High
- Med
- Med-Low
- Low
- Quiet

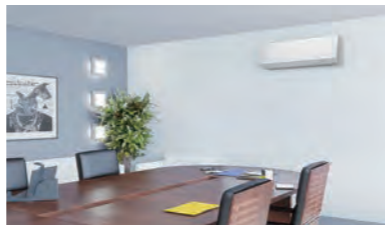

* Remote controller is compatible with the following:
UTY-RNRGZ5/UTY-RLRG/UTY-RSRG/UTY-RHRG/UTY-DCGGZ2/UTY-ALGX1/UTY-APGX1

The Occupancy sensor contributes to further energy savings.

Energy saving operation starts automatically by detecting the motion of a person. Two modes of save operation mode and stop mode can be selected.

*If you want to use the Occupancy sensor control' function, you need an setting device that can set the Occupancy sensor control' function. For example: Wired RC (Touch panel).

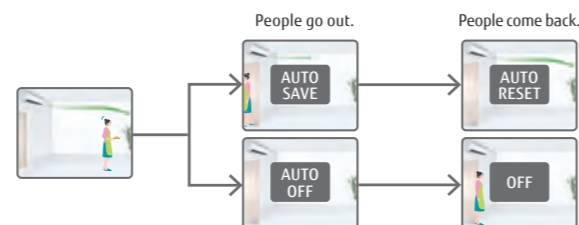

Model: ASHA004GCGH / ASHA007GCGH / ASHA009GCGH
ASHA012GCGH / ASHA014GCGH
[external EEV]
ASHE004GCEH / ASHE007GCEH / ASHE009GCEH
ASHE012GCEH / ASHE014GCEH



Specifications

| Model name | ASHA004GCGH | ASHA007GCGH | ASHA009GCGH | ASHA012GCGH | ASHA014GCGH | ASHE004GCEH | ASHE007GCEH | ASHE009GCEH | ASHE012GCEH | ASHE014GCEH |
|---------------------------------|-----------------------------|-------------|-------------|-------------|-------------|-----------------------------|-------------|-------------|-------------|-------------|
| Power source | Single phase, ~230 V, 50 Hz | | | | | Single phase, ~230 V, 50 Hz | | | | |
| Capacity | Cooling | 1.1 | 2.2 | 2.8 | 3.6 | 4.0 | 1.1 | 2.2 | 2.8 | 3.6 |
| | Heating | 1.3 | 2.8 | 3.2 | 4.0 | 4.5 | 1.3 | 2.8 | 3.2 | 4.0 |
| Input power | W | | | | | W | | | | |
| Airflow rate | High | 450 | 550 | 610 | 690 | 800 | 450 | 550 | 610 | 690 |
| | Med-High | 430 | 510 | 560 | 610 | 740 | 430 | 510 | 560 | 610 |
| | Med | 400 | 470 | 510 | 560 | 680 | 400 | 470 | 510 | 560 |
| | Med-Low | 380 | 410 | 440 | 530 | 610 | 380 | 410 | 440 | 530 |
| | Low | 360 | 360 | 360 | 470 | 550 | 360 | 360 | 360 | 470 |
| | Quiet | 310 | 310 | 310 | 330 | 330 | 310 | 310 | 310 | 330 |
| Sound pressure level | High | 31 | 34 | 37 | 40 | 44 | 31 | 35 | 43 | 44 |
| | Med-High | 30 | 32 | 35 | 37 | 42 | 30 | 32 | 38 | 42 |
| | Med | 28 | 30 | 32 | 35 | 40 | 28 | 30 | 34 | 40 |
| | Med-Low | 27 | 28 | 29 | 33 | 37 | 27 | 27 | 29 | 33 |
| | Low | 26 | 26 | 26 | 30 | 34 | 26 | 24 | 24 | 30 |
| | Quiet | 22 | 22 | 22 | 24 | 24 | 22 | 22 | 22 | 24 |
| Net Dimensions (H × W × D) | mm 268 × 840 × 203 | | | | | mm 268 × 840 × 203 | | | | |
| Weight | kg 8.0, 8.5, 8.5, 8.5, 8.5 | | | | | kg 8.0, 8.5, 8.5, 8.5, 8.5 | | | | |
| Connection pipe diameter | Liquid (Flare) | 6.35 | 6.35 | 6.35 | 6.35 | 6.35 | 6.35 | 6.35 | 6.35 | 6.35 |
| | Gas (Flare) | 9.52 | 9.52 | 9.52 | 12.70 | 12.70 | 9.52 | 9.52 | 9.52 | 12.70 |
| Drain Hose Diameter (I.D./O.D.) | mm 13.8/15.8 to 16.7 | | | | | mm 13.8/15.8 to 16.7 | | | | |
| EV kit (optional) | - | | | | | UTR-EV09XB | | UTR-EV14XB | | |

Note: Specifications are subject to the following conditions:
Cooling: Indoor temperature of 27°CDB/19°CWB, and outdoor temperature of 35°CDB/24°CWB.
Heating: Indoor temperature of 20°CDB/15°CWB, and outdoor temperature of 7°CDB/6°CWB.
Pipe length: 7.5 m; Height difference between outdoor unit and indoor unit: 0 m. Voltage: 230 [V]
When connecting ASH*004G**H, ASH*007G**H, ASH*009G**H to an outdoor unit other than the outdoor unit of the J-IVL Series, the gas pipe diameter should be Ø12.70 mm.

Optional parts

- External power supply unit: UTZ-GXXA, UTZ-GXXC*
- WLAN adapter: UTY-TFSXZ1, UTY-TFSXJ3, FG-AC-WIF1Z1
- Silver Ion Filter: UTR-FA16-5

Dimensions

(Unit: mm)

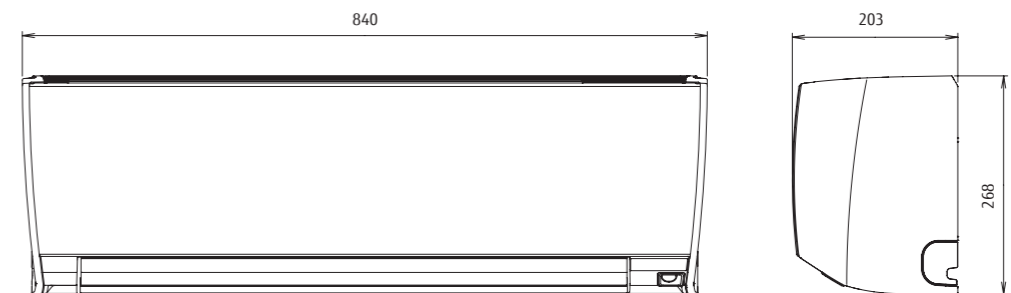

Wall-mounted type



Powerful & Comfort airflow

Powerful Airflow

(ASHA030GTEH)

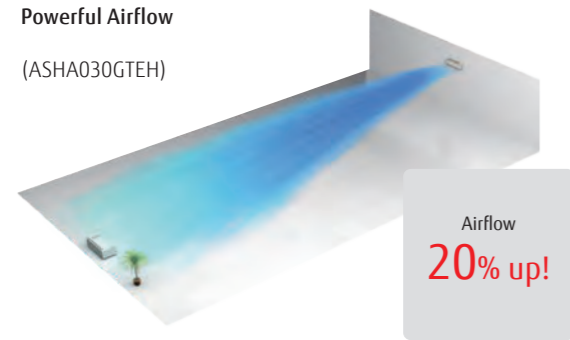

Power diffuser

(ASHA18/24GBCH)

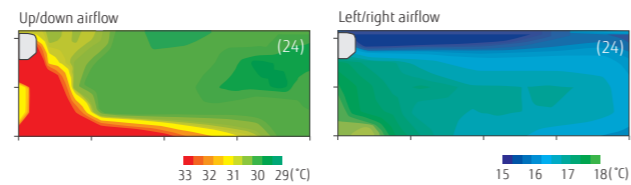

The Occupancy sensor contributes to further energy savings. (ASHA030/034GTEH only)

Energy saving operation starts automatically by detecting the motion of a person. Two modes of save operation mode and stop mode can be selected.

*If you want to use the Occupancy sensor control function, you need a setting device that can set the Occupancy sensor control function. For example: Wired RC (Touch panel).

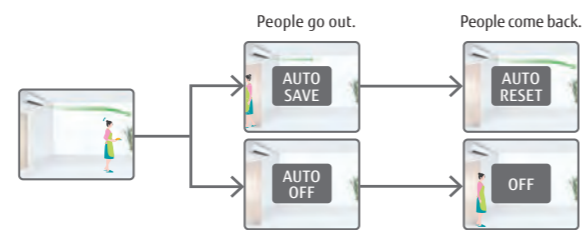

6-step fan speed control for quiet operation

The airflow pattern achieves significant noise reduction. A 6-step sound level setting allows for multiple-step silent operations.

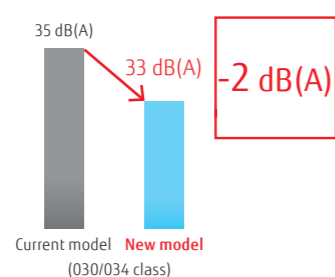

- 6-Step Speed
- High
- Med-High
- Med
- Med-Low
- Low
- Quiet



* Remote controller is compatible with the following:
UTY-RNRGZ5/UTY-RLRG/UTY-RSRG/UTY-RHRG/UTY-DCGG22/UTY-ALGXZ1/UTY-APGXZ1

Model: ASHA18GBCH / ASHA24GBCH
ASHA030GTEH / ASHA034GTEH



ASHA18/24GBCH



ASHA030/034GTEH

Specifications

| Model name | | ASHA18GBCH | ASHA24GBCH | ASHA030GTEH | ASHA034GTEH |
|---------------------------------|----------------|-----------------------------|-----------------|-------------------|-------------------|
| Power source | | Single phase, ~230 V, 50 Hz | | | |
| Capacity | Cooling | 5.6 | 7.1 | 9.0 | 10.0 |
| | Heating | 6.3 | 8.0 | 10.0 | 11.2 |
| Input power | | 32 | 60 | 74 | 103 |
| Airflow rate | High | 840 | 1,100 | 1,440 | 1,620/1,520 |
| | Med-High | - | - | 1,200 | 1,300 |
| | Med | 770 | 910 | 1,050 | 1,120 |
| | Med-Low | - | - | 940 | 980 |
| | Low | 690 | 730 | 890 | 890 |
| | Quiet | - | - | 700 | 700 |
| Sound pressure level | High | 41 | 48 | 53 | 55/54 |
| | Med-High | - | - | 49 | 51 |
| | Med | 39 | 43 | 45 | 47 |
| | Med-Low | - | - | 42 | 43 |
| | Low | 35 | 35 | 39 | 39 |
| | Quiet | - | - | 33 | 33 |
| Net Dimensions (H × W × D) | | mm 320 × 998 × 238 | 320 × 998 × 238 | 340 × 1,150 × 280 | 340 × 1,150 × 280 |
| Weight | | kg 15 | 15 | 18 | 18 |
| Connection pipe diameter | Liquid (Flare) | 6.35 | 9.52 | 9.52 | 9.52 |
| | Gas (Flare) | 12.70 | 15.88 | 15.88 | 15.88 |
| Drain Hose Diameter (I.D./O.D.) | | 12/16 | | 13.8/15.8 to 16.7 | |

Note: Specifications are subject to the following conditions:
Cooling: Indoor temperature of 27°CDB/19°CWB, and outdoor temperature of 35°CDB/24°CWB.
Heating: Indoor temperature of 20°CDB/15°CWB, and outdoor temperature of 7°CDB/6°CWB.
Pipe length: 7.5 m; Height difference between outdoor unit and indoor unit: 0 m. Voltage: 230 [V].
When connecting ASHA18GBCH to an outdoor unit other than the outdoor unit of the J-IVL Series, the pipe diameter should be Ø9.52/Ø15.88 mm (Liquid/Gas).

Optional parts

- External power supply unit: UTZ-GXXA (030/034), UTZ-GXXC* (030/034)
- Silver Ion Filter: UTR-FA13-3
- WLAN adapter: UTY-TFSXJ3 (030/034), UTY-TFSXZ1 (030/034)
FG-RC-WIF122 (18/24), FG-AC-WIF121 (030/034)

Dimensions

(Unit: mm)

Models: ASHA18/ASHA24

Models: ASHA030/ASHA034

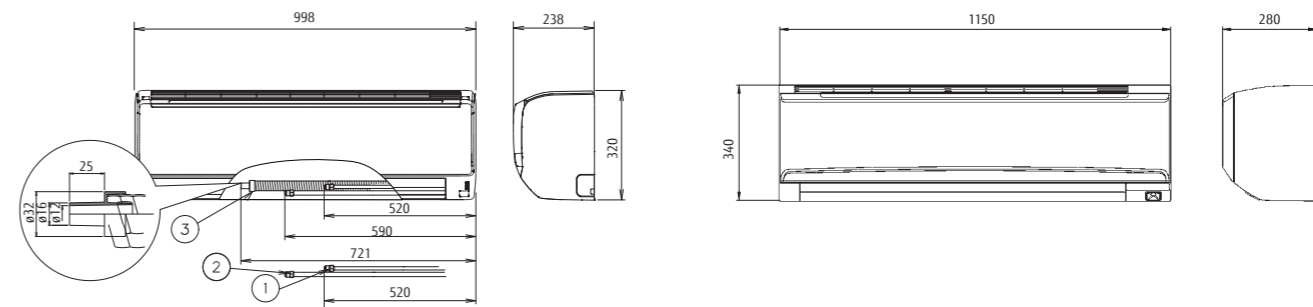

- ① Refrigerant pipe flare connection (Liquid)
- ② Refrigerant pipe flare connection (Gas)
- ③ Drain pipe connection