

EN

## OPERATING INSTRUCTIONS





# ***WATERSTAGE***

Air to Water Heat Pump  
Split integrated DHW type

---

# Contents

---

 Safety instructions	3
 Overview of installation	4
Precautions and warnings about your installation . . . . .	4
Appliance end-of-life . . . . .	5
 Carrying out the installation	6
User interface, Room control unit (option) and Room thermostat (option) . . . . .	6
Display Description . . . . .	8
Appliance start up . . . . .	9
Quick start-up . . . . .	9
Setting the time . . . . .	10
Structure of the "End user" control menu . . . . .	11
Parametering the setting . . . . .	12
Information display . . . . .	17
Details . . . . .	17
Operation of the DHW system* . . . . .	17
Selecting cooling mode* . . . . .	17
Pilot wire* (if kit regulation extension AVS 55). . .	18
Telephone modem* (if Regulation extension kit AVS 55) . . . . .	18
Configuring room control unit* (option) . . . . .	18
 Maintenance	19
Regular checks . . . . .	19
Checking the outdoor unit . . . . .	19
Hot water tank* . . . . .	19
Package fiche HP models	20



# Safety instructions

---



**Please comply with the following instructions in order to avoid any risk of injury or inappropriate use of the appliance.**



## Commissioning

Do not switch the appliance ON until every filling operation has been performed

Do not attempt to install this appliance yourself. This heat pump must be installed by qualified personnel holding a certificate of competence.

The installation must always be properly earthed and fitted with a safety circuit breaker.

Do not change the power supply.

The appliances are not fireproof and should not therefore be installed in an explosive environment.

## How to Use

This appliance can be used by children 8 years and above. Also persons with reduced physical, sensory or mental capabilities, or lack of experience and knowledge, provided they have been given supervision or instruction concerning use of the appliance in a safe way and with the appliance. Cleaning and user maintenance shall not be made by children without supervision.

Do not let children insert foreign bodies inside the propeller protection grate or climb onto the roof of the outdoor unit. The fins of the air heat exchanger are extremely thin and can cause cuts.

Nothing should obstruct the air circulation through the evaporator and out from the fan.

The outdoor unit must only be installed outside. If a shelter is required, it must have broad openings on all 4 sides and installation clearances must be observed (see your installation engineer).

Do not climb on top of the outdoor unit.

The room in which the unit is operating must be correctly ventilated in order to avoid any shortage of oxygen in the event of a refrigerant gas leak.

If your installation location already meets safety standards, do not carry out any modifications (ventilation, exhaust evacuation, openings, etc.) without the advice of your installation engineer.

Do not place any heat source under the remote control.

## Maintenance

Do not try to repair the appliance yourself.

This appliance does not contain any components which can be repaired by the user. Removing either of the covers can expose you to dangerous electrical voltages.

In any case, switching off the current is not sufficient to protect you from any external electrical shocks (condensers).

Do not open the outdoor unit or the hydraulic unit while they are in operation.

If you hear unusual noises, smell smoke or other odours coming from the appliance, turn off the power and contact your installation engineer.

Before starting any cleaning, turn off the power to the appliance.

Do not use aggressive cleaning liquids or solvents to clean the body work.

Do not use a pressure hose to clean the outdoor unit. You may damage the air exchanger and get water inside the electrical circuits.

# Overview of installation

---

## ▶ Precautions and warnings about your installation

### ▼ Outdoor unit

The outdoor unit contains the equipment that enables the capture of energy from the surrounding air.

This unit was installed by your installer in a location where it is able to operate with best performance.

Nothing should obstruct the air circulation through the evaporator and out from the fan.

The water contained in the air may condense and flow out of the outdoor unit. The outdoor unit can generate a large volume of water called condensate.

In cold weather, this water freezes on contact with the exchanger and must be regularly removed using the defrosting cycles. The defrosting cycle is managed automatically by the control system and can produce steam emissions which are completely normal.

### ▼ Hydraulic unit

The hydraulic unit contains the appliance's control system which manages the room temperature and the production of domestic hot water.

The hydraulic unit is fitted with an electrical backup\* or boiler connection\* which intervenes to provide additional heat during the coldest periods.

### ▼ Settings

Your installer has carefully adjusted your installation. Do not change the settings without their consent. If in doubt, do not hesitate to contact them.

Your heating system is controlled by adjustment in relation to the outside temperature (temperature control).

The installation of a room thermostat (option) makes it possible to improve the operation of the control system (influence of the ambient temperature is taken into account).

### ▼ Radiators

In order to ensure operation of the control system, the room containing the thermostat must not also contain a thermostatic valve. If this is the case, it must be opened as far as possible.

### ▼ Underfloor heating system

A new underfloor heating system must initially be heated slowly to avoid any problems involving cracking. Check with your installer that this initial heating procedure has indeed been performed before freely using your heating system.

An underfloor heating system's significant inertia prevents sudden room temperature differences. However, this inertia implies a reaction time of around several hours (approx 6 hours).

Any changes to the setting must be made slowly and leave the installation sufficient time to react. Any exaggerated or abrupt adjustments to the settings always result in significant temperature fluctuations during the day.

Similarly if your dwelling has an underfloor heating system, do not reduce it or switch it off if you will be absent for only short periods. The reheating period is always quite long (approx 6 hours).

### ▼ Fan coils / dynamic radiators with an integrated control system

Do not use a room sensor in the area in question.

### ▼ Domestic Hot Water (DHW)\*

When hot water is required, the heat pump adapts its priority to meet the request.

No heating is produced during the preparation of domestic hot water.

The heat pump produces the domestic hot water (DHW), which is then additionally heated, if required, by the electrical backup.

To ensure a DHW setpoint over 45°C, the electrical backup heating or boiler (boiler connection kit)\* must be left on.

The electrical backup allows the correct operation of the anti-legionella cycles.

\* depending on configuration / option

## ► Appliance end-of-life

The appliances must be dismantled and recycled by a specialised service. The appliances must not, under any circumstances, be thrown out with household waste, bulky waste or at a tip.

At the end of its service life, please contact your installer or local representative to proceed with its dismantling and recycling.

## ► Overview of the installation

Your heat pump has been configured by your installation engineer. It is made up of the following main parts:

- The outdoor unit, as its name suggests, is placed outside your dwelling, and extracts energy from the outside air.
- The hydraulic unit is located in your boiler room, cellar, garage or even in your kitchen, and transfers energy to the heating and domestic hot water circuits\*.
- The outside sensor monitors the outside temperature.

*Optional:*

- Room sensor(s).

Heat pumps are systems which can be connected to any type of **low temperature distribution system** and the heat captured by the heat pump can be used in different ways:

- Underfloor heating system.
- Radiators.
- Domestic Hot Water (DHW)\*.

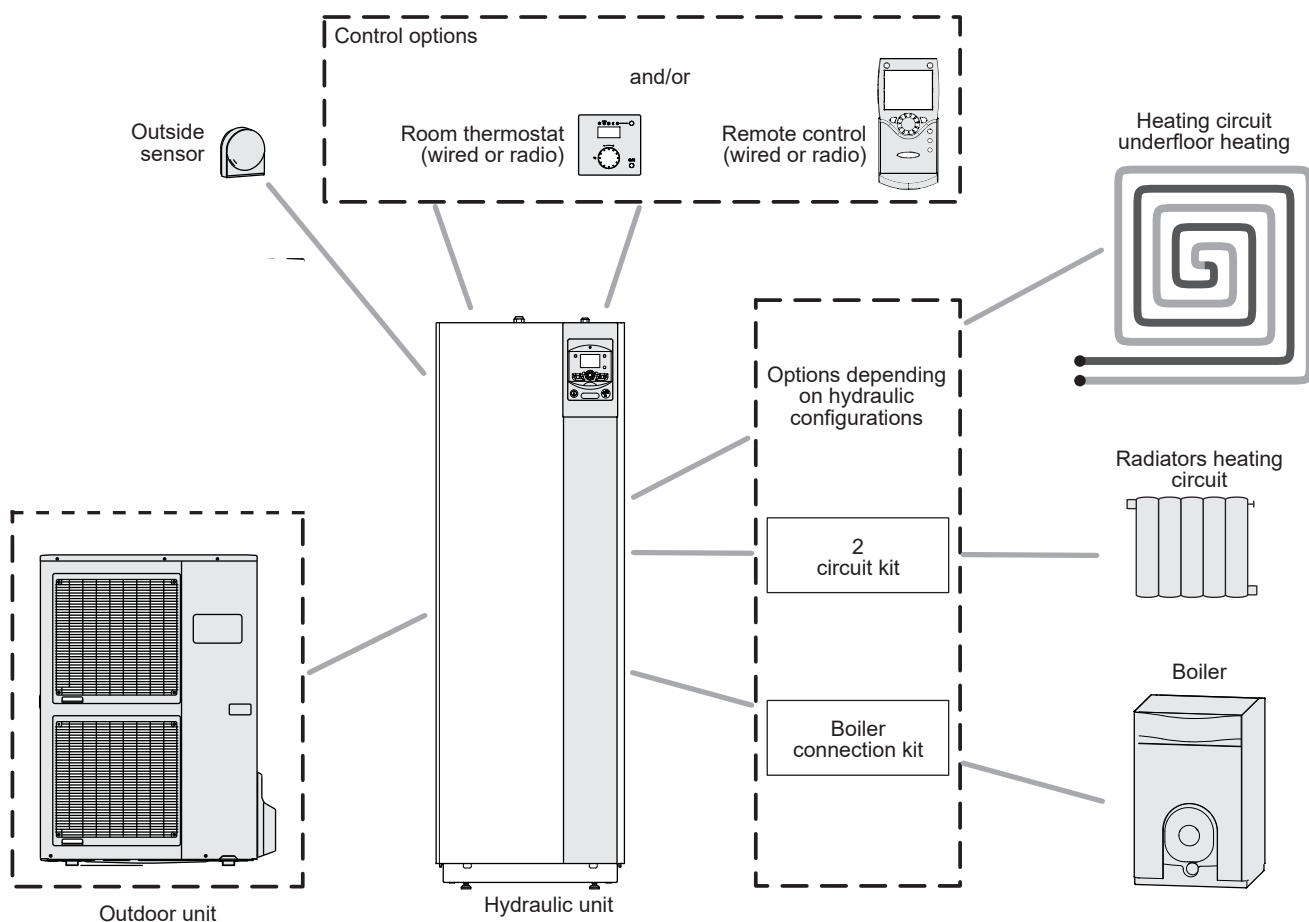
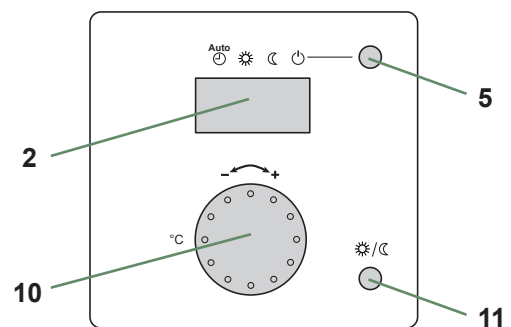
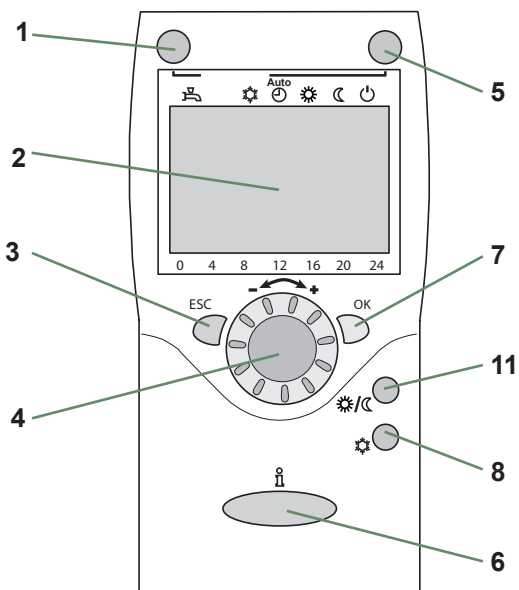
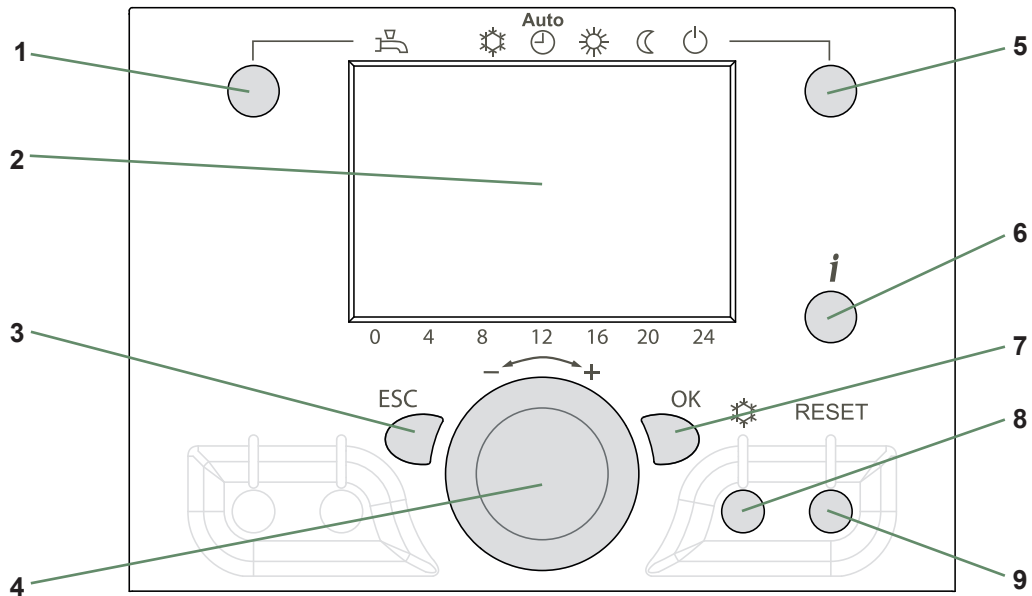












fig. 1 - Overview of complete installation configuration

\* depending on configuration / option

# Carrying out the installation

► User interface, Room control unit (option) and Room thermostat (option)



Ref.	Functions	- Definitions
1	Selecting of the DHW operating mode (Domestic hot water).   On  Off	<ul style="list-style-type: none"> <li>- If the installation is fitted with a DHW tank.</li> <li>- <b>On</b>: Production of DHW according to the time program.</li> <li>- <b>Off</b>: Preparing the domestic hot water for stopping with the anti-frost function active.</li> <li>- <b>Manual start button</b>: Hold down the DHW key for 3 seconds. Switch from "reduced" to "comfort" until the next time the ECS timer switches over.</li> </ul>
2	Digital display.	<ul style="list-style-type: none"> <li>- Operating control. Readout of the current temperature, of the heating mode and of any faults  .</li> <li>- View the settings.</li> </ul>
3	Exit "ESC".	<ul style="list-style-type: none"> <li>- Quit the menu.</li> </ul>
4	Navigation and setting.	<ul style="list-style-type: none"> <li>- Selecting the menu.</li> <li>- Setting parameters.</li> <li>- Adjusting the ambient temperature setpoint.</li> </ul>
5	Selecting the heating mode.	<ul style="list-style-type: none"> <li>-  Heating operating according to the heating program (Summer/winter mode switchover is automatic).</li> <li>-  Constant comfort temperature.</li> <li>-  Constant reduced temperature.</li> <li>-  Stand-by mode with anti-frost protection (Provided that the heat pump's electrical power supply is not interrupted).</li> </ul>
6	Information display.	<ul style="list-style-type: none"> <li>- Various data (see <a href="#">page 17</a>).</li> <li>-  Reading error codes.</li> <li>-  Information concerning maintenance, special mode.</li> </ul>
7	Confirm "OK".	<ul style="list-style-type: none"> <li>- Input into the selected menu.</li> <li>- Confirmation of the parameter settings.</li> <li>- Confirmation of the adjustment to the comfort temp. setting.</li> </ul>
8	Selecting cooling mode.	<ul style="list-style-type: none"> <li>- If the installation is fitted with the cooling kit:</li> <li>-  Cooling operating according to the heating program (Summer/winter mode switchover is automatic).</li> </ul>
9	RESET button (Brief press)	<ul style="list-style-type: none"> <li>- Reinitialising the parameters and cancelling error messages.</li> </ul> <p><b>Do not use during normal operation.</b></p>
10	Control knob.	<ul style="list-style-type: none"> <li>- Adjusting the ambient temperature setpoint.</li> </ul>
11	Presence key.	<ul style="list-style-type: none"> <li>- Comfort / Reduced switchover.</li> </ul>

## ► Display Description

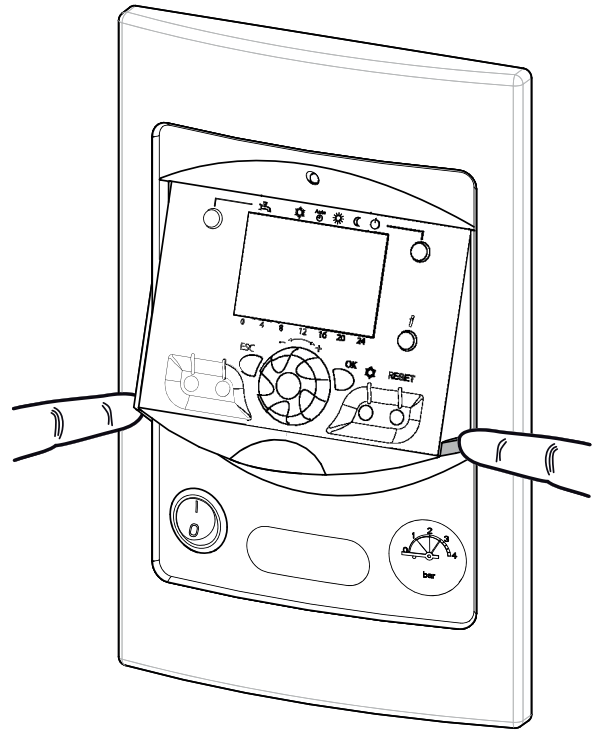
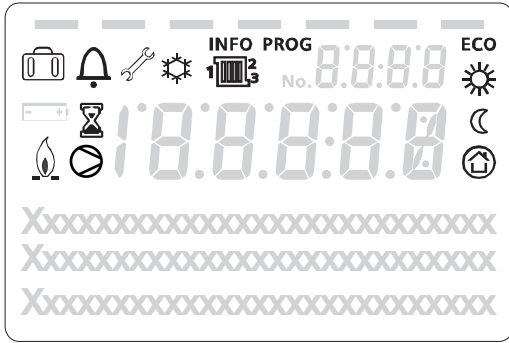


fig. 3 - Closing the display

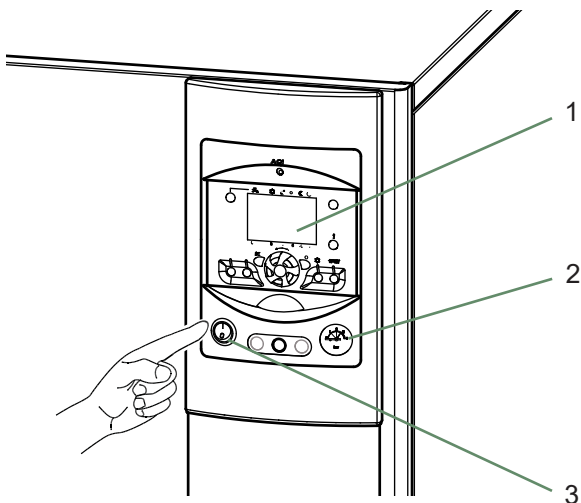
Symbols	Definitions
	- Heating mode active with reference to the heating circuit*.
	- Heating in comfort mode.
	- Heating in reduced mode.
	- Heating in "standby" mode (freeze protection).
	- Cooling mode active*.
	- Holiday mode activated.
	- Process in progress.
	- Compressor operation.
	- Burner operation*.
	- Default message.
	- Service / Special operation.
<b>INFO</b>	- Information level activated.
<b>PROG</b>	- Program activated.
<b>ECO</b>	- ECO mode activated (Heating temporarily stopped).
	- Hour / Parameter number / Setpoint value.
	- Room temperature / Setpoint value.
	- Setpoint information / Parameter Information.

\* depending on configuration / option



## ► Appliance start up

- The installation and 1st start up of the appliance must be done by a qualified installer. That person will also give you instructions on starting and running the appliance.
- Ensure that the installation is fully filled with water and has been correctly bled and that there is a sufficient pressure of 1.5 to 2 bars on the manometer (ref. 2, fig. 4).
- Close the installation's main circuit breaker.  
In winter, so that the compressor can be preheated, close the installation's main circuit breaker (outdoor unit's power supply) some hours before pressing the on/off button.



1. User interface
2. Manometer (installation hydraulic pressure)
3. Start/stop switch

fig. 4 - Start-up

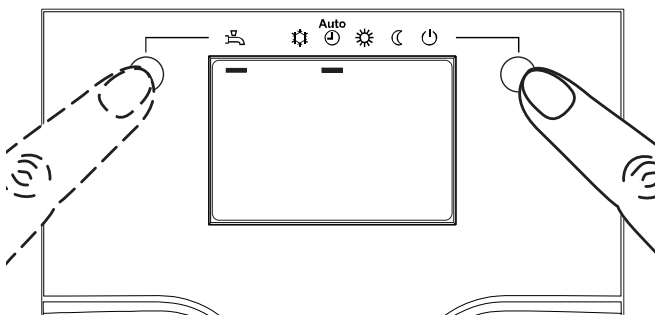
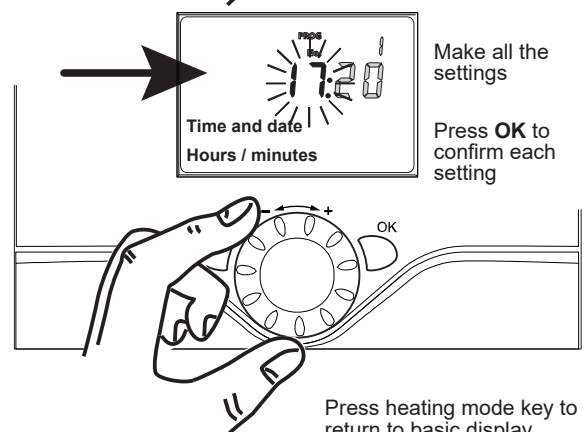
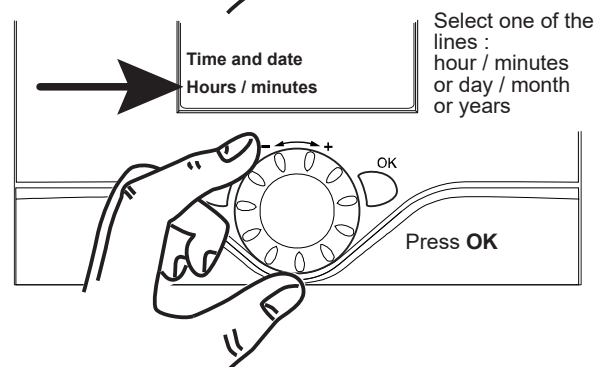
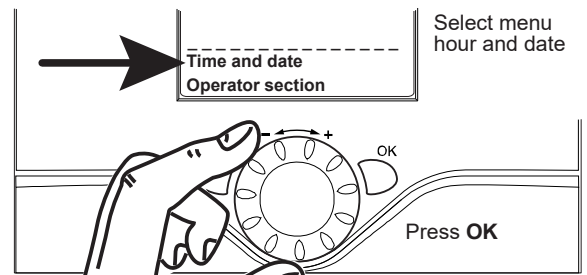
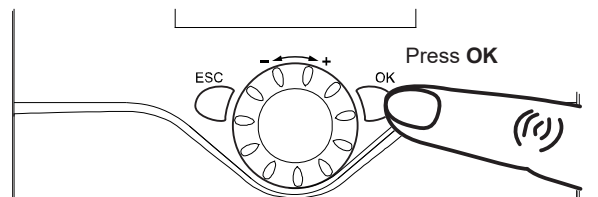


fig. 5 - Selecting the heating mode AUTO and Select the DHW mode

## ► Quick start-up

Once your installer has started your installation for the first time:

- Engage the start/stop switch.  
During the regulator initialisation phase, the display shows all the symbols and then "Data, update" and then "State heat pump".
- Select the "AUTO" heating mode (fig. 5).
- Select the DHW mode (fig. 5).
- Adjust the date and time if necessary (fig. 6)).



Press heating mode key to return to basic display

fig. 6 - Setting the time and the date

## ► Setting the time

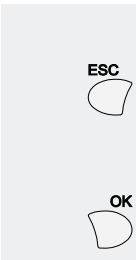
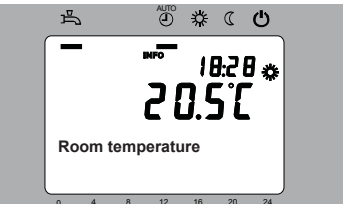
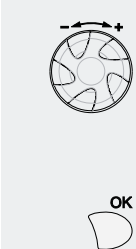
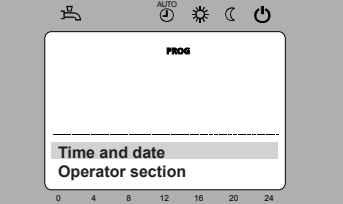
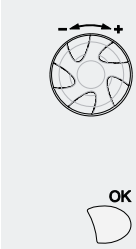
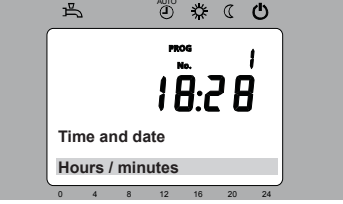



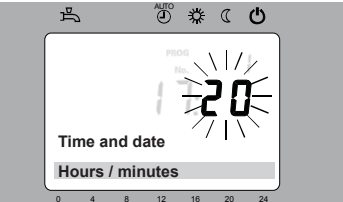
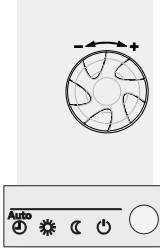
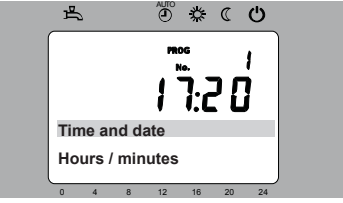
Keys	Display example	Description
1 		Basic display  If the basic display is not shown, press <b>ESC</b> to return to it  Press <b>OK</b> to confirm.
2 		Turn the knob Select menu hour and date  Press <b>OK</b> to confirm.
3 		Turn the knob  Select line 1 Hours / minutes  Press <b>OK</b> to confirm.
4 		The hour display flashes  Turn the knob to set the time  Press <b>OK</b> to confirm.
5 		The minutes display flashes  Turn the knob to set the minutes  Press <b>OK</b> to confirm.
6 		The setting are recorded  Turn the knob to make other settings  or Press heating mode key to return to basic display.

fig. 7 -

## ► Structure of the "End user" control menu

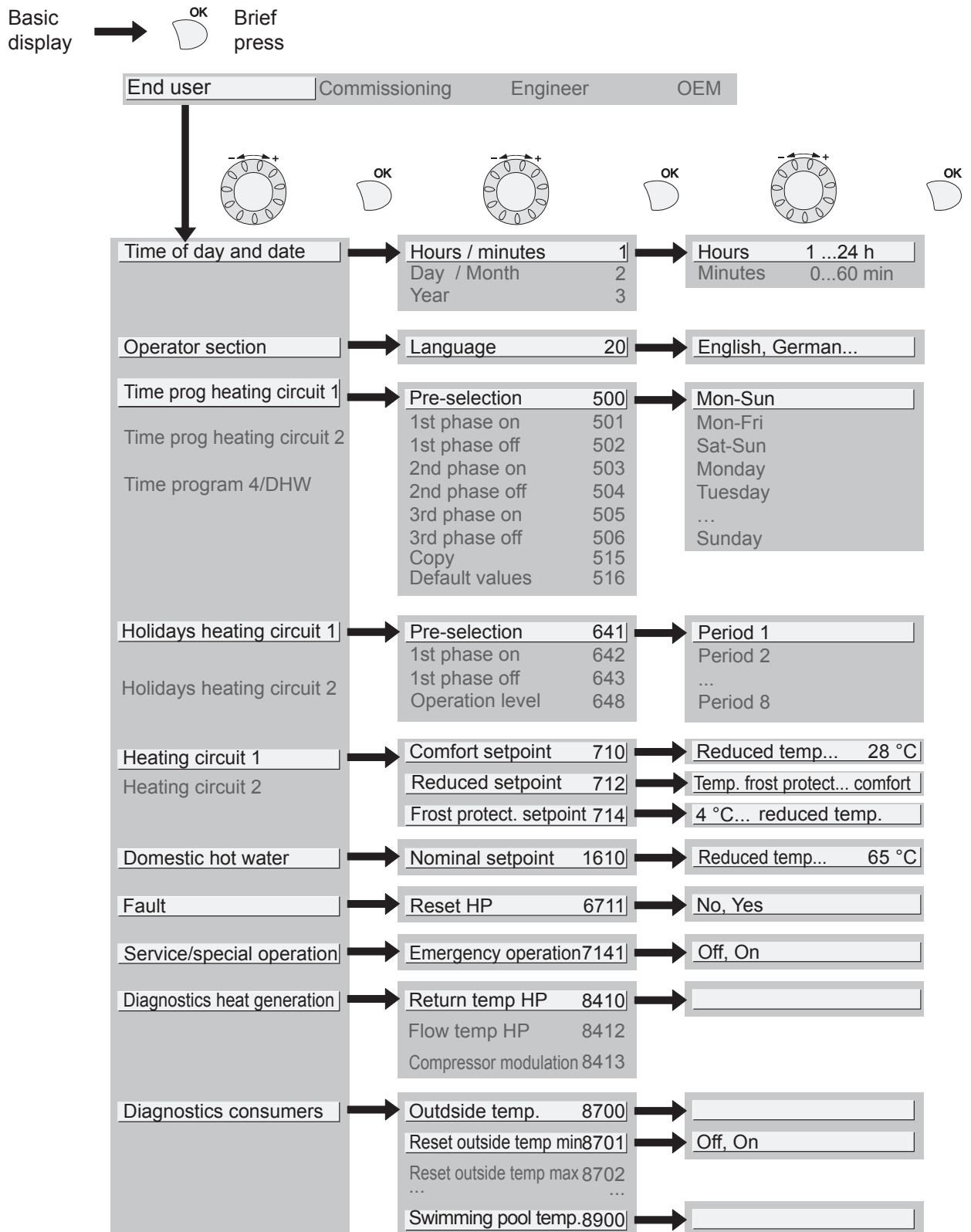


fig. 8 -

## ► Parametering the setting

### ▼ General

Only the parameters accessible to levels:

End user

... are described in this document.

The parameters accessible at level:

Commissioning

Engineer

... are described in the document reserved for these professional specialists. Do not make any modifications to these parameters without advice from these professional specialists. **Incorrect use of any kind may result in serious malfunctioning.**

### ▼ Setting parameters

With the screen on basic display.

- Press **OK**.

Once in "End user" level.

- Scroll the menu list.

- Choose the desired menu.

- Scroll the function lines.

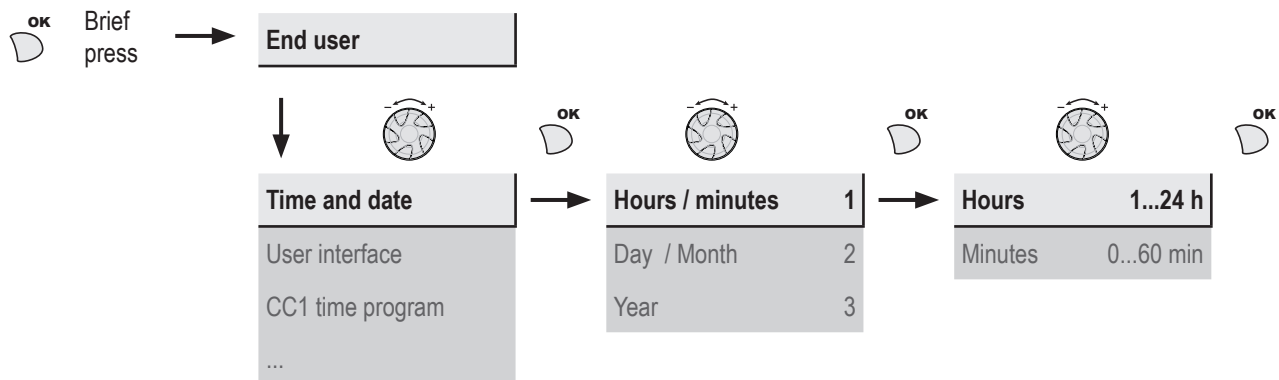
- Choose the desired line.

- Adjust the parameter.

- Check the setting by pressing **OK**.

- To return the menu, press **ESC**.

If no setting is made for 8 minutes, the screen returns automatically to the basic display.



### ▼ List of "End user" settings

Line	Function	Setting range or display	Setting increment	Basic setting
<b>Time of day and date</b>				
1	Hours / Minutes	00:00... 23:59	1	
2	Day / Month	01.01... 31.12	1	
3	Year	1900... 2099	1	
<b>Operator Section</b>				
20	Language	English, Français, Italiano, Nederlands...		<b>English</b>

<b>Line</b>	<b>Function</b>	<b>Setting range or display</b>	<b>Setting increment</b>	<b>Basic setting</b>
<b>Time program heating / cooling, circuit 1</b>				
<b>500</b>	Pre-selection (Day / Week)	Mon-Sun, Mon-Fri, Sat-Sun, Monday, Tuesday, ...		<b>Mon-Sun</b>
<b>501</b>	1st phase On (start)	00:00... --:--	10 min	<b>6:00</b>
<b>502</b>	1st phase Off (end)	00:00... --:--	10 min	<b>22:00</b>
<b>503</b>	2nd phase On (start)	00:00... --:--	10 min	<b>--:--</b>
<b>504</b>	2nd phase Off (end)	00:00... --:--	10 min	<b>--:--</b>
<b>505</b>	3rd phase On (start)	00:00... --:--	10 min	<b>--:--</b>
<b>506</b>	3rd phase Off (end)	00:00... --:--	10 min	<b>--:--</b>
<b>516</b>	Default values, Circuit 1	No, Yes		<b>No</b>
Yes + OK: The default values memorised in the regulator replace and cancel the customised heating programs. Your customised settings are therefore lost.				
<b>Time program heating / cooling, circuit 2</b>				
Only with the 2nd circuit kit option.				
<b>520</b>	Pre-selection (Day / Week)	Mon-Sun, Mon-Fri, Sat-Sun, Monday, Tuesday, ...		<b>Mon-Sun</b>
<b>521</b>	1st phase On (start)	00:00... --:--	10 min	<b>6:00</b>
<b>522</b>	1st phase Off (end)	00:00... --:--	10 min	<b>22:00</b>
<b>523</b>	2nd phase On (start)	00:00... --:--	10 min	<b>--:--</b>
<b>524</b>	2nd phase Off (end)	00:00... --:--	10 min	<b>--:--</b>
<b>525</b>	3rd phase On (start)	00:00... --:--	10 min	<b>--:--</b>
<b>526</b>	3rd phase Off (end)	00:00... --:--	10 min	<b>--:--</b>
<b>536</b>	Default values, Circuit 2	No, Yes		<b>No</b>
Yes + OK: The default values memorised in the regulator replace and cancel the customised heating programs. Your customised settings are therefore lost.				
<b>Time program 4 / DHW</b>				
If the installation is fitted with the DHW kit.				
<b>560</b>	Pre-selection (Day / Week)	Mon-Sun, Mon-Fri, Sat-Sun, Monday, Tuesday, ...		<b>Mon-Sun</b>
<b>561</b>	1st phase On (start)	00:00... --:--	10 min	<b>00:00</b>
<b>562</b>	1st phase Off (end)	00:00... --:--	10 min	<b>05:00</b>
<b>563</b>	2nd phase On (start)	00:00... --:--	10 min	<b>14:30</b>
<b>564</b>	2nd phase Off (end)	00:00... --:--	10 min	<b>17:00</b>
<b>565</b>	3rd phase On (start)	00:00... --:--	10 min	<b>--:--</b>
<b>566</b>	3rd phase Off (end)	00:00... --:--	10 min	<b>--:--</b>
<b>576</b>	Default values	No, Yes		<b>No</b>
Yes + OK: The default values memorised in the regulator replace and cancel the customised heating programs. Your customised settings are therefore lost.				
<b>Holidays, heating circuit 1</b> (For the Holiday program is active, the heating mode should be on AUTO).				
<b>641</b>	Preselection	Period 1 to 8		<b>Period 1</b>
<b>642</b>	Period Start (Day / Month)	01.01... 31.12	1	
<b>643</b>	Period End (Day / Month)	01.01... 31.12	1	
<b>648</b>	Operating level	Frost protection, Reduced		<b>Frost protection</b>


<i>Line</i>	<i>Function</i>	<i>Setting range or display</i>	<i>Setting increment</i>	<i>Basic setting</i>
<b>Holidays, heating circuit 2</b> (For the Holiday program is active, the heating mode should be on AUTO).				
If the installation consists of 2 heating circuits (Only with the 2nd circuit kit option).				
<b>651</b>	Preselection	Period 1 to 8		<b>Period 1</b>
<b>652</b>	Period Start (Day / Month)	01.01... 31.12	1	
<b>653</b>	Period End (Day / Month)	01.01... 31.12	1	
<b>658</b>	Operating level	Frost protection, Reduced		<b>Frost protection</b>
<b>Heating adjustment, circuit 1</b>				
<b>710</b>	Comfort setpoint	Reduced setpoint... Comfort setpoint maximum	0.5 °C	<b>20 °C</b>
<b>712</b>	Reduced setpoint	Frost protection setpoint... Comfort setpoint	0.5 °C	<b>19 °C</b>
<b>714</b>	Frost protection setpoint	4 °C... Reduced setpoint	0.5 °C	<b>8 °C</b>
<b>Cooling circuit 1</b>				
If the installation is fitted with the cooling kit (Only with the cooling kit option).				
<b>901</b>	Operating mode	Protection, Automatic, Reduced, Comfort		<b>Protection</b>
<b>902</b>	Comfort cooling setpoint	17... 40 °C	0.5 °C	<b>24 °C</b>
<b>903</b>	Reduced setpoint	5... 40°C		<b>26 °C</b>
<b>Heating adjustment, Circuit 2</b>				
Only with the 2nd circuit kit option (If the installation consists of 2 heating circuits).				
<b>1010</b>	Comfort setpoint	Reduced setpoint... Comfort setpoint maximum	0.5 °C	<b>20 °C</b>
<b>1012</b>	Reduced setpoint	Frost protection setpoint... Comfort setpoint	0.5 °C	<b>19 °C</b>
<b>1014</b>	Frost protection setpoint	4 °C... Reduced setpoint	0.5 °C	<b>8 °C</b>
<b>Cooling circuit 2</b>				
If the installation is fitted with the cooling kit (Only with the cooling kit option).				
<b>1201</b>	Operating mode	Protection, Automatic, Reduced, Comfort		<b>Protection</b>
<b>1202</b>	Comfort cooling setpoint	17... 40 °C	0.5 °C	<b>24 °C</b>
<b>1203</b>	Reduced setpoint	5... 40°C		<b>26 °C</b>
<b>Domestic hot water</b>				
If the installation is fitted with the DHW kit.				
<b>1600</b>	Operating mode	Off, On, Eco		<b>On</b>
<b>1610</b>	Nominal setpoint	Reduced setpoint (line 1612)... 65 °C	1	<b>55 °C</b>
The backup electrical system is required to reach this level.				
<b>1612</b>	Reduced setting	8 °C... Nominal setting (line 1610)	1	<b>40 °C</b>
<b>Swimming pool</b> (Only with swimming pool kit option)				
<b>2055</b>	Setpoint solar heating	8... 80 °C		<b>26 °C</b>
<b>2056</b>	Setpoint source heating	8... 35 °C		<b>22 °C</b>

<b>Line</b>	<b>Function</b>	<b>Setting range or display</b>	<b>Setting increment</b>	<b>Basic setting</b>
<b>Energy meter</b>				
<b>3095 --&gt; 3110 : Not used</b>				
<b>3113</b>	Energy brought in		Kwh	--
<b>Cumulation of total consumed electrical energy.</b>				
Electrical energy consumed = Electrical energy absorbed by outdoor unit + electric energy absorbed by the heating electrical backup and / or DHW electrical backup (if installed).				
<b>3121 --&gt; 3123 : Not used</b>				
<b>3124</b>	Energy brought in heating 1 (N - 1)		Kwh	--
<b>3125</b>	Energy brought in DHW 1		Kwh	--
<b>3126</b>	Energy brought in cooling 1		Kwh	--
<b>3128 --&gt; 3130 : Not used</b>				
<b>3131</b>	Energy brought in heating 2 (N - 2)		Kwh	--
<b>3132</b>	Energy brought in DHW 2		Kwh	--
<b>3133</b>	Energy brought in cooling 2		Kwh	--
<b>3135 --&gt; 3137 : Not used</b>				
<b>3138</b>	Energy brought in heating 3 (N - 3)		Kwh	--
<b>3139</b>	Energy brought in DHW 3		Kwh	--
<b>3140</b>	Energy brought in cooling 3		Kwh	--
<b>3142 --&gt; 3144 : Not used</b>				
<b>3145</b>	Energy brought in heating 4 (N - 4)		Kwh	--
<b>3146</b>	Energy brought in DHW 4		Kwh	--
<b>3147</b>	Energy brought in cooling 4		Kwh	--
<b>3149 --&gt; 3151 : Not used</b>				
<b>3152</b>	Energy brought in heating 5 (N - 5)		Kwh	--
<b>3153</b>	Energy brought in DHW 5		Kwh	--
<b>3154</b>	Energy brought in cooling 5		Kwh	--
<b>3156 --&gt; 3158 : Not used</b>				
<b>3159</b>	Energy brought in heating 6 (N - 6)		Kwh	--
<b>3160</b>	Energy brought in DHW 6		Kwh	--
<b>3161</b>	Energy brought in cooling 6		Kwh	--
<b>3163 --&gt; 3165 : Not used</b>				
<b>3166</b>	Energy brought in heating 7 (N - 7)		Kwh	--
<b>3167</b>	Energy brought in DHW 7		Kwh	--
<b>3168</b>	Energy brought in cooling 7		Kwh	--
<b>3170 --&gt; 3172 : Not used</b>				
<b>3173</b>	Energy brought in heating 8 (N - 8)		Kwh	--
<b>3174</b>	Energy brought in DHW 8		Kwh	--
<b>3175</b>	Energy brought in cooling 8		Kwh	--
<b>3177 --&gt; 3179 : Not used</b>				

<i>Line</i>	<i>Function</i>	<i>Setting range or display</i>	<i>Setting increment</i>	<i>Basic setting</i>
3180	Energy brought in heating 9 (N - 9)		Kwh	--
3181	Energy brought in DHW 9		Kwh	--
3182	Energy brought in cooling 9		Kwh	--
<b>3184 --&gt; 3186 : Not used</b>				
3187	Energy brought in heating 10 (N - 10)		Kwh	--
3188	Energy brought in DHW 10		Kwh	--
3189	Energy brought in cooling 10		Kwh	--
<b>390 --&gt; 3267 : Not used</b>				
<b>Error</b>				
6710	Reset Defaut relais	No, Yes		<b>No</b>
6711	Reset HP	No, Yes		<b>No</b>
<b>Maintenance / special regime</b>				
7141	Emergency operation	Off, On		<b>Off</b>
	Off: Heat pump functions normally (with boosters if necessary). On: Heat pump uses the electric boost system or the boiler connection. Use the "On" position only in Assist mode or Test mode: may result in high power bills.			
<b>Generator diagnosis</b>				
8410	Return temp HP	0... 140 °C		--
	Setpoint (flow) HP			--
8412	Flow temp HP	0... 140 °C		--
	Setpoint (flow) HP			--
8413	Compressor modulation	0... 100%		--
<b>Diagnostics consumers</b>				
8700	Outdoor temperature	-50... 50 °C		--
8701	Outdoor temp min Reset ? (no, yes)	-50... 50 °C		<b>50 °C</b>
8702	Outdoor temp max Reset ? (no, yes)	-50... 50 °C		<b>-50 °C</b>
8740	Room temperature 1	0... 50 °C		--
	Room setting 1			<b>20 °C</b>
8743	Flow temperature 1	0... 140 °C		--
	Flow temperature setpoint 1			--
8756	Cooling flow temperature 1	0... 140 °C		--
	Cooling flow temperature setpoint 1			--
8830	DHW (domestic hot water) temperature	0... 140 °C		--
	DHW temperature setpoint			<b>50 °C</b>



## ► Information display

Various data can be displayed by pressing the info button .

Depending on the type of unit, configuration and operating state, some of the info lines listed below may not appear.

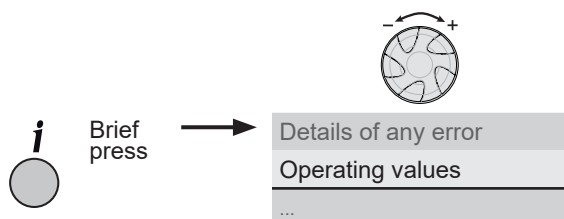




fig. 2 - Information key

- Possible error messages: The display shows the "Bell" symbol .

**Consult your heating technician.**

- Service messages ; Special mode messages: The display shows the "Key" symbol .

**Consult your heating technician.**

- Various data (see below).

Designation	Line
Floor drying current setpoint .	-
Current drying day.	-
Terminated drying days.	-
State heat pump.	8006
State supplementary source.	8022
State DHW.	8003
State swimming pool.	8011
State heating circuit 1.	8000
State heating circuit 2.	8001
State cooling circuit 1.	8004
Outdoor temperature.	8700
Room temperature 1.	8740
Room setpoint 1.	
Flow temperature 1.	8743
Flow temperature setpoint1.	
Room temperature 2.	8770
Room setpoint 2.	
Flow temperature 2.	8773
Flow temperature setpoint 2.	
DHW (domestic hot water) temperature.	8830
Heat pump return temperature.	8410
Setpoint (return) HP.	
Heat pump flow temperature.	8412
Setpoint (flow) HP.	
Swimming pool temperature.	8900
Swimming pool temperature setpoint.	
Minimum remaining stop time for compressor 1.	-
Minimum remaining running time for compressor 1.	-

## ► Details

If the electrical power supply has been cut off while the heat pump is operating (electrical power failure or unprogrammed pressing of the on/off switch on the hydraulic unit) the display will show error 370 when the appliance restarts. Do not be concerned, the communication between the outdoor and hydraulic unit will re-establish itself in a few moments.

## ► Operation of the DHW system\*

The key enables you to switch the DHW (domestic hot water) mode on and off. The selection is shown by a bar, which appears under the corresponding symbol.

Manual activation: Hold down the DHW key for 3 seconds (Switch from "reduced" to "nominal" until the next time the DHW timer switches over).

To ensure a DHW setting over 45°C, the electrical back-up heating or the boiler must be left on.

In order to optimise operation of the DHW, it is possible to:

- Program the timer settings (parameters **560** to **576**),
- Adjust the comfort temperature set point (parameter **1610**),
- Adjust the reduced temperature set point (parameter **1612**).

Press the info key to obtain the details on the DHW (temperature setting operation).

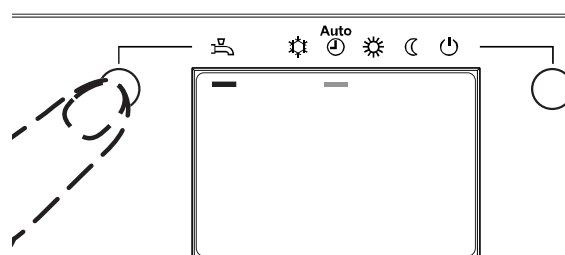


fig. 9 - Select the DHW mode

## ► Selecting cooling mode\*

If the installation is fitted with the cooling kit.

The key activates and deactivates cooling mode.

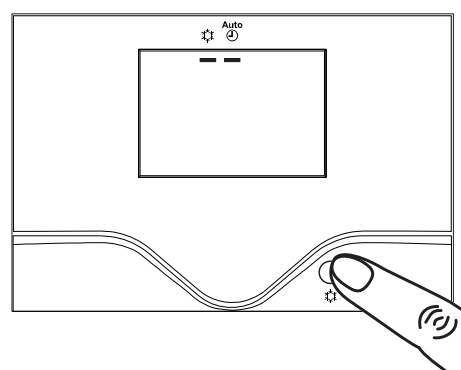


fig. 10 - Selecting cooling mode

## ► Pilot wire\* (if kit regulation extension AVS 55)

It's possible to order up to 15 electric heaters via output "pilot wire".

The "pilot wire" handles only the hourly operation of electric heaters (comfort mode / reduced mode commutation and Frost protection mode).

The comfort temperature setting should be done directly on the electric heater(s). The "pilot wire" does not handle the temperature of the electric heaters. Refer to the manual supplied with the electric heater(s).

Put the electric heaters on "**PROG**" mode or "**AUTO**" mode for piloting by the regulation board.

The difference between the comfort temperature and the reduced temperature is from 3.5°C.

Frost protection temperature is set directly on the electric heaters. Refer to the manual supplied with the electric heater(s).

In the absence of signal, electric heaters operating in comfort mode.

## ► Telephone modem\* (if Regulation extension kit AVS 55)

It is possible to command the switching of the heating mode to the "freeze" protection mode / reduced (and vice versa) on the heat pump using a modem contact.

The telephone command switches the current heat pump settings to "freeze" protection mode / reduced (and vice versa). In accordance with the setting, any temperature requests from the heating circuits and the DHW are ignored or activated.

The "freeze" protection mode / reduced must not be selected on the heat pump and/or the remote control.

See with your installer.

## ► Configuring room control unit\* (option)

In the event that the room control unit (see page 6), is used, on start-up, after initialising for around 3 minutes, the language needs setting:

- Press **OK**.
- Choose menu "Operator section".
- Choose language "Language" **English**.

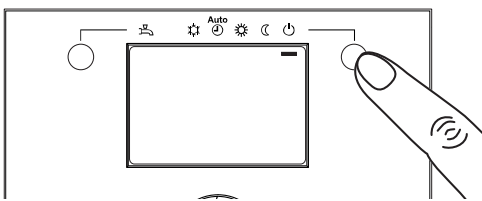


fig. 11 - Selecting the frost protection

\* depending on configuration / option

# Maintenance

---

In order to ensure that your appliance operates correctly for many years, the maintenance operations described below are required at the start of each heating season. They are generally carried out as part of a maintenance contract.

## ► Regular checks

- Check the water pressure in the heating circuit regularly (refer to the installer's recommended pressure - between 1 and 2 bar)
- If a filling operation and a pressure increase are required, check what type of fluid was used initially (when in doubt, contact your installer).
  
- If frequent refills are required it is absolutely essential that you check for any leaks.

**The frequent addition of water risks scaling the exchanger and affects its performance and lifespan.**

## ► Checking the outdoor unit

Remove any dust from the exchanger, if necessary, while making sure not to damage the blades.  
Check that there is nothing blocking the air flow.

### • Checking the refrigeration circuit

If the amount of refrigerant in the system exceeds 2kg (models > 10 kW), the refrigeration circuit must be checked annually by an approved engineer (they must have a certificate of competence for the handling of refrigerants).

**Consult your heating technician.**

## ► Hot water tank\*

Maintenance on the tank must be carried out annually (frequency may vary according to water hardness).

**Consult your heating technician.**

\* depending on configuration / option

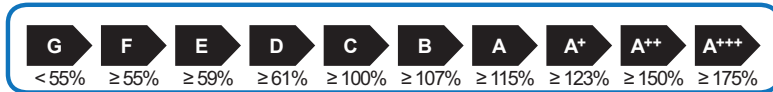


This unit is identified by this symbol. It means that all electrical and electronic products must not be included in household waste. A specific recycling system for this type of product has been set up in European Union countries (\*), Norway, Iceland and Liechtenstein. Do not try to dismantle this product yourself. It may have damaging effects on your health or on the environment. Reprocessing of the refrigerant, lubricant and other parts may be performed by a qualified installer in compliance with the local and national legislation in force. This unit must be recycled by a specialised service and in no case may it be thrown away with household waste, rubble or in a landfill. Please contact your installer or local representative for more .

\* Depending on the national regulations of each member state.

# Package fiche HP models

## ■ Application 35 °C

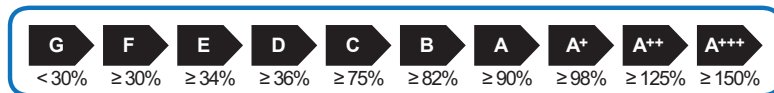


Models	Waterstage DHW...		HP 11 Single phase type		HP 14 Single phase type		HP 11 3-Phase		HP 14 3-Phase		HP 16 3-Phase	
<b>Hydraulic unit reference</b>			<b>WGYG140DG6</b>		<b>WGYG140DG6</b>		<b>WGYK160DG9</b>		<b>WGYK160DG9</b>		<b>WGYK160DG9</b>	
Seasonal space heating energy efficiency of heat pump			151%		148%		154%		150%		149%	
Type of temperature control (* = Outdoor sensor ; ** = Room unit)			*class II	**class VI	*class II	**class VI	*class II	**class VI	*class II	**class VI	*class II	**class VI
Bonus			2%	4%	2%	4%	2%	4%	2%	4%	2%	4%
Seasonal space heating energy efficiency of package <b>under average climate</b>			153%	155%	150%	152%	156%	158%	152%	154%	151%	153%
Energy class of package			A++	A++	A++	A++	A++	A++	A++	A++	A++	A++
Seasonal space heating energy efficiency of package <b>under warmer climate</b>			173%	175%	178%	180%	207%	209%	198%	200%	190%	192%
Seasonal space heating energy efficiency of package <b>under colder climate</b>			123%	125%	120%	122%	126%	128%	124%	126%	121%	123%

The energy efficiency of the package of products provided for in this fiche may not correspond to its actual energy efficiency once installed in a building, as the efficiency is influenced by further factors such as heat loss in the distribution system and the dimensioning of the products in relation to building size and characteristics.

Electrical back up heater consumption is taken into account in the performance calculation.

## ■ Application 55 °C



Models	Waterstage DHW...		HP 11 Single phase type		HP 14 Single phase type		HP 11 3-Phase		HP 14 3-Phase		HP 16 3-Phase	
<b>Hydraulic unit reference</b>			<b>WGYG140DG6</b>		<b>WGYG140DG6</b>		<b>WGYK160DG9</b>		<b>WGYK160DG9</b>		<b>WGYK160DG9</b>	
Seasonal space heating energy efficiency of heat pump			112%		113%		112%		117%		117%	
Type of temperature control (* = Outdoor sensor ; ** = Room unit)			*class II	**class VI	*class II	**class VI	*class II	**class VI	*class II	**class VI	*class II	**class VI
Bonus			2%	4%	2%	4%	2%	4%	2%	4%	2%	4%
Seasonal space heating energy efficiency of package <b>under average climate</b>			114%	116%	115%	117%	114%	116%	119%	121%	119%	121%
Energy class of package			A+	A+	A+	A+	A+	A+	A+	A+	A+	A+
Seasonal space heating energy efficiency of package <b>under warmer climate</b>			122%	124%	121%	123%	138%	140%	139%	141%	143%	145%
Seasonal space heating energy efficiency of package <b>under colder climate</b>			102%	104%	102%	104%	102%	104%	102%	104%	102%	104%

The energy efficiency of the package of products provided for in this fiche may not correspond to its actual energy efficiency once installed in a building, as the efficiency is influenced by further factors such as heat loss in the distribution system and the dimensioning of the products in relation to building size and characteristics.

Electrical back up heater consumption is taken into account in the performance calculation.

Outdoor sensor included in the package	
Controller class	II
Contribution to energy efficiency	2%
Room unit references	UTW-C55XA UTW-C58XD UTW-C74TXF UTW-C74HXF UTW-C78XD
Controller class	VI
Contribution to energy efficiency	4%



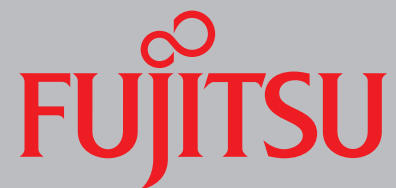
A series of horizontal dotted lines spanning the width of the page, providing a guide for handwriting practice.



A series of horizontal dotted lines spanning the width of the page, providing a guide for handwriting practice.

*Date of installation :*

*Contact of your heating technician or your after-sales service.*



Fujitsu General (Euro) GmbH  
Fritz-Vomfelde-Strasse 26-32  
40547 Düsseldorf - Germany